

REFERENCE GUIDE

Laser Marking Systems



Datalogic at a glance

Datalogic is a global technology leader in the **automatic data capture** and **factory automation markets**, specialized in the designing and production of **barcode readers, mobile computers, sensors** for detection, **measurement** and **safety, RFID, vision** and **laser marking systems**.

Closeness and timely response to every customer requirement, together with continuous innovation and high quality offering, are the distinctive elements at the base of Datalogic success for over 40 years. Its cutting-edge solutions help to increase the efficiency and quality of processes in the **Retail, Manufacturing, Transportation & Logistics** and **Healthcare** industries, along the entire value chain.

DATALOGIC TARGET INDUSTRIES



RETAIL

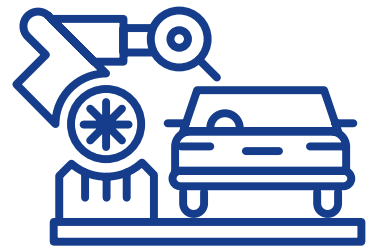

MANUFACTURING



TRANSPORTATION
& LOGISTICS

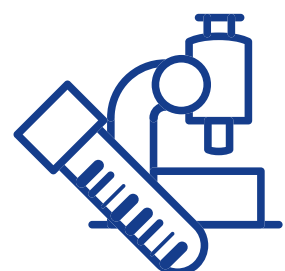

HEALTHCARE

DATALOGIC PRODUCTS



Handheld Scanners

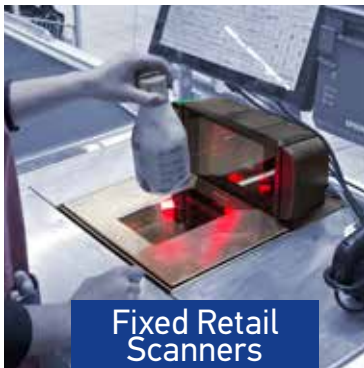

Fixed Retail Scanners



Mobile Computers



Stationary Industrial Scanners

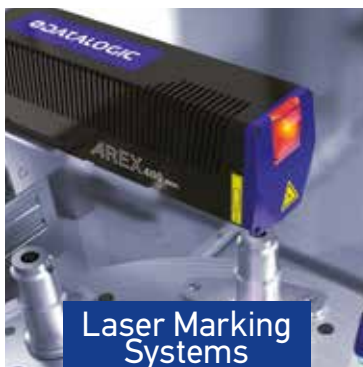

Laser Marking Systems



Machine Vision



Sensors & Safety



OEM Barcode Readers



RFID Systems



CUSTOMER SERVICE

Datalogic's Customer Service offers a wide and complete range of post-sales services. It is organized in three levels of support, in order to guarantee the most appropriate professional assistance based on the specific problem. Datalogic's Customer Service can deploy in each territory a team of multi-lingual professionals, with a broad technical expertise across the whole product range.

Our standard service portfolio includes: warranty extension, fast turnaround time for repairs, 24/7/365 phone support, next day on-site intervention and site audits. Datalogic can tailor the service offering to your specific needs. Our experts will support every stage of your projects, from feasibility study to extended post-sales support, performing, when necessary, root cause analysis and remediation.



EASEOFCARE Service Programs

Datalogic's EASEOFCARE Service Programs provide superior life-cycle support to ensure that products are always operating at peak performance. A variety of Service Programs are available to match your business requirements:



FAST REPAIR TURNAROUND (OVERNIGHT/2 DAYS)



ACCIDENTAL DAMAGE COVERAGE



BOTH WAYS FREIGHT PAID BY DATALOGIC



DATALOGIC SHIELD FOR MOBILE PRODUCTS INCLUDED



3-5 YEARS CONTRACT SERVICE OPTIONS

Please contact your sales representative to find out what type of services are available in your region.

www.datalogic.com

INDEX

Datalogic laser marking overview	6
What is laser marking? How does it work?	8
Advantages of laser marking	9
Laser marking processes	10
Laser marking technologies	16
Laser applications	18
Automotive	20
Electronics	22
Food	24
Pharmaceutical	26
Lighter software & laser marking products	28
Laser marking Application Map	42
Laser marking Materials Map	44
Accessories	48



DATALOGIC LASER MARKING OVERVIEW

Datalogic Laser Marking is able to provide the best laser technology solution for your application, from fiber laser to solid state.

With the increasing popularity of Fiber lasers in recent years, Datalogic invested aggressively in this technology, and now it is important to choose the best technology for the application and material that meets the requirements for speed, quality and cost. Datalogic's product portfolio provides users the ability to select the perfect technology to provide the best results through the most efficient solution. No other manufacturer is so vertically integrated on Fiber technology (Pulsed and MOPA), Solid State technology (IR, GRIP).



TECHNOLOGY TIMELINE

1993	1994	1995	1996	1997	2000	2002	2003	2003
Laservall SPA was founded	Laservall is the leader of jewelry laser welding	VIOLINO First industrial grade DPSS laser marker	Medical, Aesthetical, Dental laser sources were introduced	KUBO is the new family of stand alone spot welders	New Production plant in Sesto Calende. Large class 1000 clean rooms	Laservall Asia was founded	Laservall Korea was founded	Eurmarker low cost laser marker

state and CO₂, powered by the latest software platform and hardware controller.

we can offer a complete range of proprietary fiber laser sources. Moreover, when selecting a laser marker it is and budget.

a single software platform with flexible controller and integration I/O options.

EEN & UV) software and hardware controllers, scanning heads and marking system design!

TECHNOLOGIES

SOLID STATE

High Peak power,
Multi wavelength,
for demanding
marking materials

CO₂

Consolidated
technology for painted,
coated or organic
material

FIBER LASER

High reliability fiber
laser technology

2004	2006	2007	2008	2011	2012	2013	2013	2014	2015	2016	2018
Datalogic acquires Laservall SPA	XELL was introduced	Datalogic provides 550 laser systems for Spanish DNI (Documento Nacional de Identidad)	ULYXE first ultra compact all-in-one laser marker introduced	EOX, CO ₂ laser marker introduced	AREX fiber laser based marking system introduced	Datalogic introduces FILOS fiber laser source based on proprietary technology	Datalogic acquires high power pulsed fiber laser assets and technology of Multiwave Photonics S.A.	Datalogic offers the most complete range of laser marking products and sources	UniQ™ fiber laser marker introduced	Datalogic introduces AREX 20MW, M.O.P.A. fiber laser maker.	Datalogic introduce AREX400 the new generation of industrial grade fiber laser markers

WHAT IS LASER MARKING? HOW DOES IT WORK?

Laser marking is a way to permanently mark a physical item for branding, tracking, coding, personalizing, either for security or quality control reasons.

During the process, an intense, collimated laser light beam is focused on the surface of a target. By scanning this concentrated spot with moving mirrors on the target's surface the laser beam can create image.

Depending on laser source characteristics, an instantaneous peak power density of several hundred kilowatts are delivered on the target causing instantaneous modification to the surface.

Laser Marking does not involve the use of inks, masks, solvents, acids, nor does it require tools which contact the engraving surface and wear over time. These properties distinguish laser engraving from alternative engraving or marking technologies where inks or bit heads have to be replaced regularly.

While most forms of engraving result in a loss of some of the marked material when it is etched away, laser marking results in essentially no loss of material. Instead, the laser is used to create a shift in the color of the material, creating a visible, virtually indestructible mark with minimal impact to the item.

Laser marking's environmental impact is low, since the technology does not utilize inks, solvents, or other consumables. Environmentally-conscious companies realize both the cost savings and environmental friendliness to laser marking solutions.

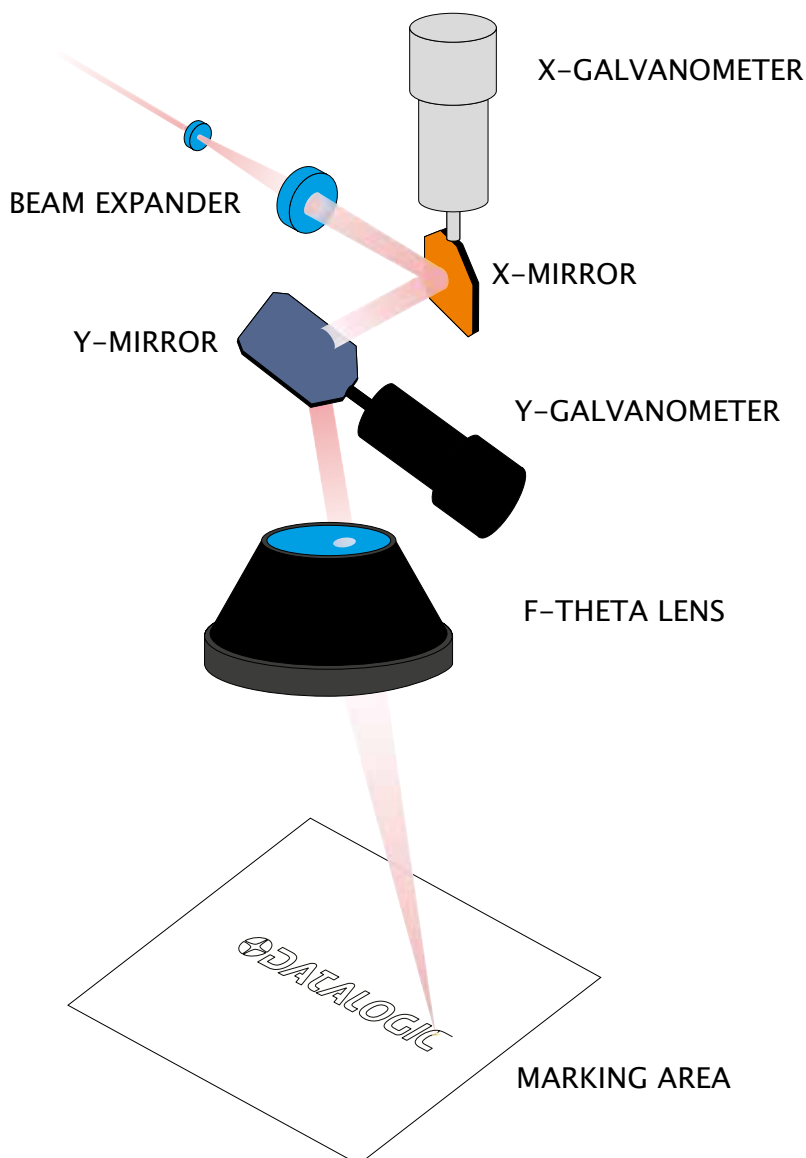

Laser marking is obtained by delivering and focusing a laser beam on a target surface with motorized mirrors controlled by dedicated hardware and software. Synchronizing the XY movement with the power modulation of the laser beam a non-contact and permanent mark is applied to the target surface.

ADVANTAGES OF LASER MARKING

Laser marking technology is the preferred choice in manufacturing due to its intrinsic advantages:

PERMANENT & DURABLE

Abrasion proof, water, solvent, oil, temperature, UV resistant marking counterfeit proof
strong interaction with substrate: Tamper proof, impossible to alter or remove

LONG TERM CONTRAST & READABILITY

Human and machine readable over long periods of time

NON CONTACT, CLEAN & DRY

Solvent and ink free with no mechanical interactions with materials, complex clamping or special handling systems, with no drying time

FAST - HIGH PRODUCTIVITY

On-the-fly and static marking with up to 1000 characters per second

HIGH RESOLUTION, HIGH QUALITY

High resolution for graphics, logos or fonts, up to 600 DPI

FLEXIBLE

Fixed, variable, or dynamic text, full vectorial and bitmap graphics, 1D & 2D bar codes

RELIABLE & ENVIRONMENTALLY FRIENDLY

No paint, ink, acid, solvents or chemicals with no waste or downtime. Excellent energy efficiency.



LASER MARKING PROCESSES

1 - Annealing

Materials:

Ferrous metals (iron, steel)
Titanium

Laser marking product:

AREX Series- Fiber Laser Marker
VLASE Series – DPSS Laser Marker
UNIQ™ - Fiber Laser Marker

Laser annealing is a marking technique that uses laser irradiation to thermally induce local oxidation without noticeable material ablation, this process creates an indelible, permanent black mark without any cracks, depressions or burrs suitable for already finished surfaces like high surface precision on surgical instruments and tools.

Typical annealing processes usually penetrate 20 to 30 μm deep in the metal surface, resulting in a stable marking that is corrosion-proof ensuring the mark cannot be removed by acid, solvents, or abrasive techniques.

This dark, permanent mark is perfect for medical device applications where marks withstand passivation, salt spray testing, and autoclaving and where material removal is prohibited to ensure part integrity and surface quality.

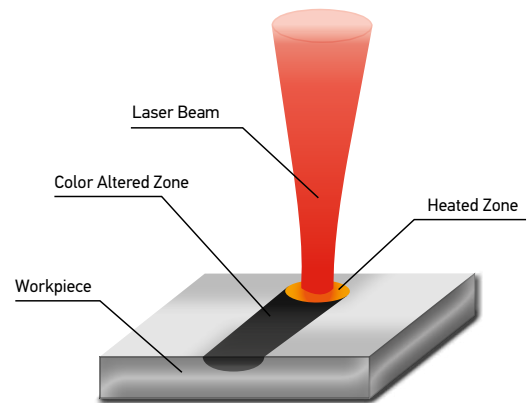

2 - Engraving

Materials:

Metals
Thermoplastic
Paper, wood, organics

Laser marking products:

AREX Series- Fiber Laser Marker
VLASE Series – DPSS Laser Marker
EOX Series – CO₂ Laser Marker
UNIQ™ - Fiber Laser Marker

In laser engraving, the laser beam locally overheats the workpiece material to the vaporization point. In some cases, thermal effects are very evident with large Heat Affected Zones (HAZ), colored oxides can be produced at the bottom or the engraving further accentuating the marking.

A depression is created in the workpiece through melting displacement and/or vaporization of material. Typical engraving depths vary between 0,001mm to 0,1mm and almost any material can be engraved with a suitable laser source (Fiber, YAG, CO₂).

Deep engraving is a method to create durable, direct and forgery-proof product marking which is resistance to wear and corrosion, even after painting or coating processes as used in automotive applications.

Deep engraving also includes 3D marking, which is the progressive removal of several layers of material at different depths to create a three-dimensional carving into the workpiece. 3D marking relies on external devices to reposition the focus field to affect different layers along the Z axis. Typical deep engraving depths vary between 0,1mm to 5mm.

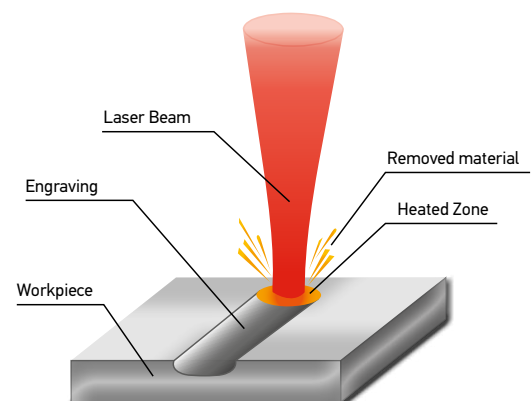

3 - Surface etching

Material marked:

Metals

Laser marking product:

AREX series - Fiber Laser Marker
VLASE series - DPSS Laser Marker
ULYXE - Compact DPSS Laser Marker
UNIQT[™] - Fiber Laser Marker

The laser etching process consists of using laser irradiation to alter the superficial finish of a metal and create contrast by enhancing the way it reflects ambient light. Depth of penetration usually does not exceed 0.01mm. Laser etching is probably the most widely used high speed laser marking process.

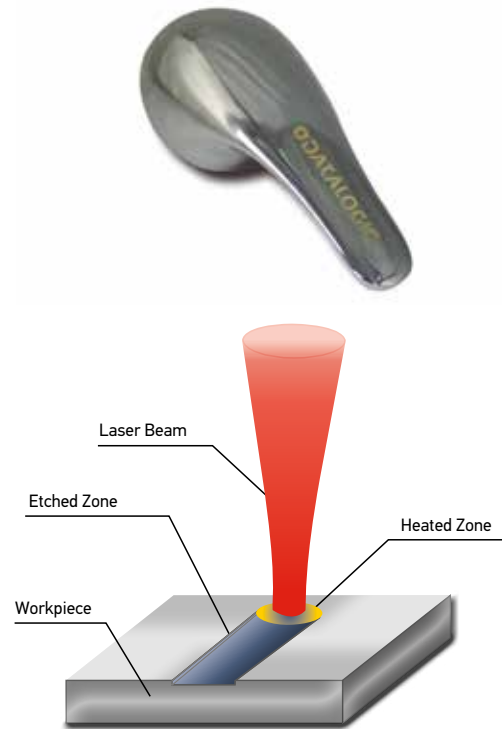

4 - Coating ablation /Paint stripping

Materials:

ANY, depending on coating

Laser marking product:

AREX Series- Fiber Laser Marker
VLASE Series - DPSS Laser Marker
EOX Series - CO₂ Laser Marker
UNIQT[™] - Fiber Laser Marker

Ablation marking process consists of the partial/complete removal of one or more coating layers which exposes the contrasting color of the substrate material. This process is popular for backlight marking and 'night & day' buttons and keys in the automotive, computer and mobile electronics industries, where a dark spray coating is applied on a transparent substrate, and then selectively ablated by laser irradiation. Short pulses with high peak reduces the thermal impact on the material resulting in high resolution marking. Laser ablation can also be used to prepare substrates for other steps in the production process. For example welding of oily, dirty or oxidized surface or when an electrical contact is needed on metal frames. In these applications, cleaning and chemical agents can be eliminated and replaced with laser ablation.

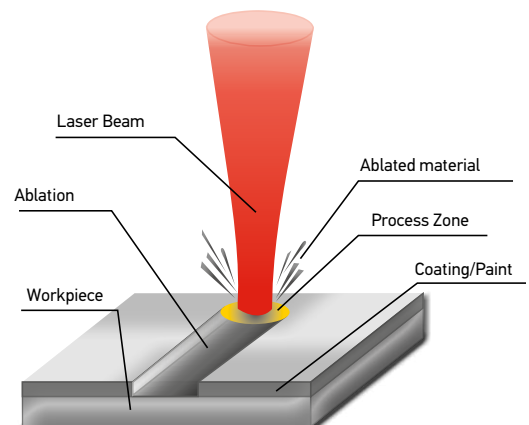

LASER MARKING PROCESSES

5 - Foaming

Materials:

Thermoplastic Materials

Laser marking product:

AREX Series- Fiber Laser Marker
VLASE Series – DPSS Laser Marker
UNIQT™ - Fiber Laser Marker

Due to laser absorption and low thermal conductivity the local workpiece temperature rises to its melting point. Small gas bubbles appear in the molten material, which increases its volume creating a type of plastic foam. The processed area appears much brighter than the surrounding material. This process is typically enhanced using laser marking additives that increase contrast and the reliability of the marking process. The foaming marking process is usually tactile and with poor scratch resistance.

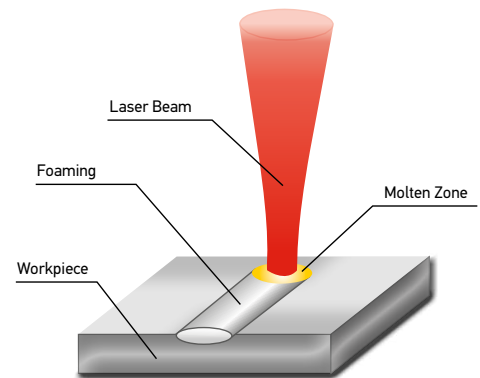

6 - Color change / Blackening / Bleaching

Materials:

Thermoplastic Materials

Laser marking product:

AREX Series- Fiber Laser Marker
VLASE Series – DPSS Laser Marker
UNIQT™ - Fiber Laser Marker

On some thermoplastic materials “green lasers” (second harmonic lasers @ 532 nm) and “UV lasers” (third harmonic lasers @ 355 nm) can be used for bleaching and photo reduction marking processes.

This effect is also called “cold marking” for the reduced “thermal footprint” on the substrate.

great benefits in terms of contrast, speed and stability of the marking process, can be The use of laser-sensitive additives in plastics can generate considerable advantages. Additives in plastics are able to increase outline sharpness and contrast and thus boost readability of the marking contents e.g. of machine-readable codes. Used with transparent and semi-transparent materials, additives lead to a uniform contrast dispersal. Additives in plastics increase the diversity of product colors and are of crucial importance for the markability of certain materials.

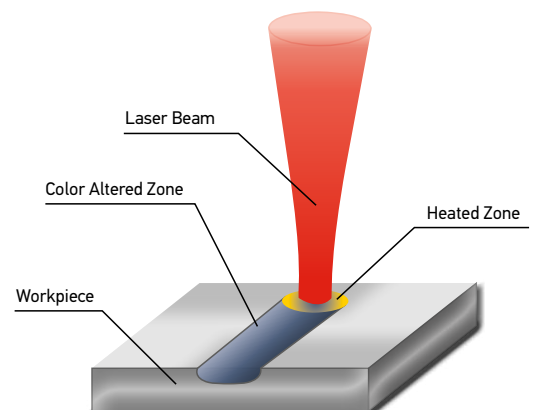

7 - Carbonization/Engraving With Carbonization

Materials:

Thermoplastic Materials
Paper, Wood, Organics

Laser marking product:

AREX Series- Fiber Laser Marker
VLASE Series – DPSS Laser Marker
EOX – Series – CO2 Laser

Carbonization of one or more specific pigments, flame retardants or other additives will provide consistent marking with sharp contrast in most light colored thermoplastic materials. Engraving may be present depending on the vaporization of the material and its absorption level.

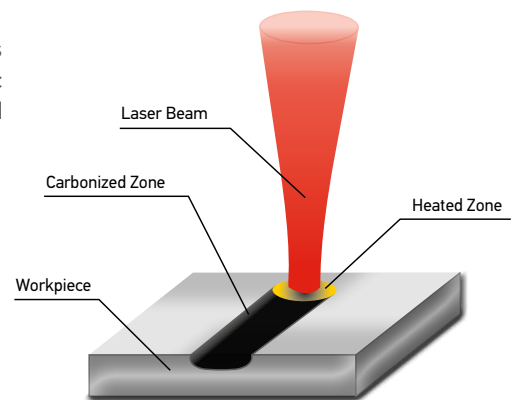

8 - SubSurface Laser Engraving (SSLE)

Materials:

Glass, transparent materials

Laser marking product:

VLASE Series – DPSS Laser Marker

Focusing intense laser radiation below the surface of a glass object creates a mark made of micro-cracks induced by localized absorption of the laser light. As a result, microscopic cracks cause multiple internal light reflections which makes the spot look white. Without affecting the polished surfaces, two and three dimensional images can be created inside of the glass. The images are created dot by dot and the workpiece is moved in two or three dimensions. This technique is popular for decoration as well as tamper-proof traceability.

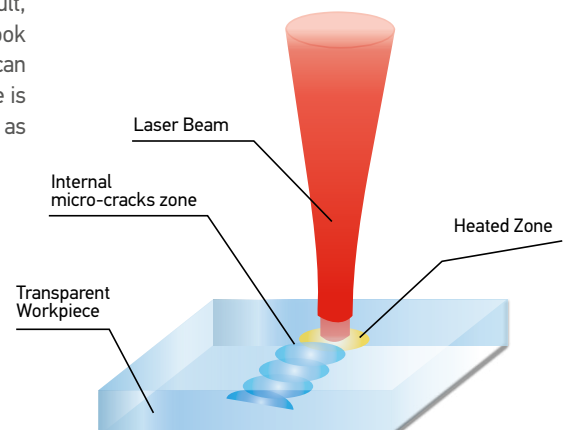

LASER MARKING PROCESSES

9 - Color Marking On Ferrous Metals And Titanium

Materials:

Ferrous metals (iron, steel)
Titanium

Laser marking product:

AREX 20 MW – MOPA Fiber Laser Marker



Laser Color Marking of stainless steel and titanium is a well-known marking technique but still with a limited diffusion in the industry.

Like laser annealing, laser color marking is based on surface oxidation, varying different laser parameters will result in different oxide coatings that can be seen as different colors by the viewer.

Most important parameters in laser marking are the focal spot diameter, power on sample, marking speed, line spacing, marking direction, repetition rate and pulse length.

Thanks to the capability to control laser pulse-width, and to its high stability, MOPA fiber lasers enable homogeneous and reliable color marking on ferrous metals and titanium.

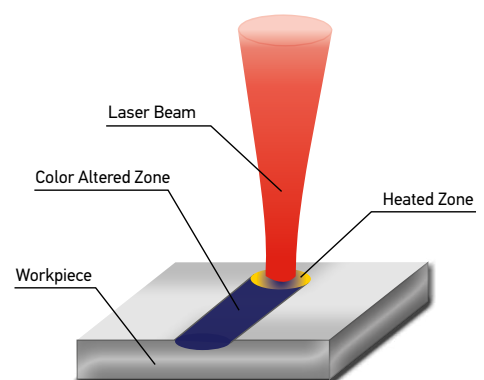

10 - Black Marking On Anodized Aluminum

Materials:

Anodized aluminum

Laser marking product:

AREX 20 MW – MOPA Fiber Laser Marker



The so called “black marking” is a technique widely used by mobile device manufacturers to mark logos and serial numbers on the anodized aluminum case with high contrast, pleasing appearance and feel and no damage on the protective oxide layer.

Thanks to the capability to run at short pulses, to the high level of control of energy and peak power, Mopa fiber lasers are the best choice to combine real black appearance with the benefits of laser marking without corrupting the corrosion properties of the coated material.

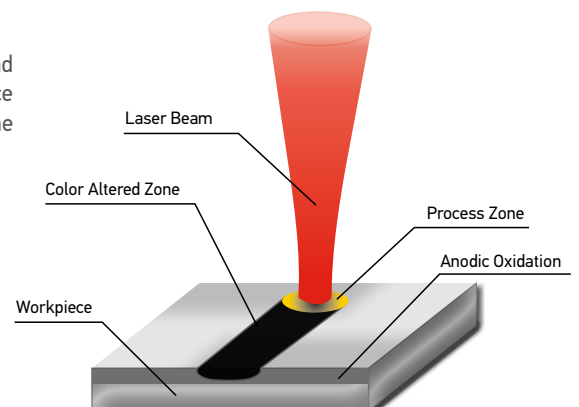

LASER MARKING TECHNOLOGIES

FIBER LASER

Fiber lasers are not new in Industrial Laser Marking, CW fiber sources have been used for high speed marking of integrated circuits (IC) since 1998. In recent years, fiber lasers have tremendously progressed in terms of flexibility and overall performance enabling the 'Fiber Revolution' in the laser market.

With a monolithic, solid state, fiber-to-fiber design which eliminates mirrors and optics to align or adjust, fiber lasers have technological advantages that dramatically improve reliability and repeatability of laser processes.

Fiber lasers also offer integration and operational advantages:

- Fiber lasers are compact and deliver their energy through an flexible optical fiber
- Fiber lasers are scalable and more efficient than any other laser technology, with wall-plug efficiencies greater than 30%
- Fiber lasers offer higher and stable beam quality and excellent pulse-to-pulse stability ensuring the best repeatability over time, especially for critical marking processes
- Q-Switched Fiber lasers offer a long pulse-width (typ 100 nsec) that make these sources the first choice for marking metal in the automotive industry
- MULTIWAVE M.O.P.A. fiber laser technology offers the capability to select the emission pulsewidth from 4 ns to 250 ns ensuring superb marking performances in term of process optimization and repeatability.

APPLICATIONS & MATERIALS



High contrast marking on metal



Engraving & deep engraving on metal



Color change on thermoplastic polymer with additive

LASER MARKING TECHNOLOGIES

SOLID STATE LASER

Diode Pumped Solid State Lasers (DPSSL) represent the most consolidated technology for laser marking applications and are still the most flexible solution to generate green and UV laser radiation.

The capability to provide extremely high peak power (up to 10 times higher than standard Fiber Lasers) and short pulse duration, make these laser sources very aggressive for difficult-to-mark materials such as highly reflective metals (copper, brass, silver, gold,...) or very stable polymer plastic.

Solid state lasers emission @ 1064 nm can be efficiently converted into GREEN emission @532 nm (SHG Second Harmonic Generation) and UV emission @355nm (THG Third Harmonic Generation) enabling the capability to engrave virtually any kind of material with extremely high resolution and reduced Heat Affected Zones (HAZ). DPSSL are ideal for even thermally sensitive materials like silicon wafers, WLCSP, thin memory cards, ICs or highly reflective materials (copper, gold, silver).

DPSSL lasers are suitable to process, damage free marking process high tech, multilayers, sensitive materials and components in Aerospace, and high technology Industry.

- DPSSL lasers offer highest Peak Power and Short pulse width, providing cold process, extremely aggressive marking spot, even on stable and hard to engrave materials.
- DPSSL lasers are easy to repair.
- DPSSL lasers are available even with GREEN and UV emission, for low thermal footprint marking process.
- DPSSL lasers are the first choice for Thermoplastic Polymer Marking in electronics / electromechanical Industry.

APPLICATIONS & MATERIALS - INFRARED



Color change on high stability plastic polymer



Paint stripping, coating removal



Night & day



Paint stripping



Surface modification



High contrast marking on highly reflective metal



Green: marking on copper



UV glass marking

CO₂ LASER

Developed over 50 years ago, the CO₂ laser has captured the largest portion of the laser materials processing market. Current day CO₂ lasers are the best solutions for high thermal impact marking with wavelengths 10x longer than DPSS and Fiber lasers. The long wavelength (10600 nm) is extremely efficient on typical packaging materials, such as:

- Paper, Corrugated Cardboard
- Glass, Ceramic
- Plastic polymer , Rubber
- Painted, coated material (metals, plastic PCB)

APPLICATIONS & MATERIALS



PCB marking



Packaging materials - heat sensitive coatings

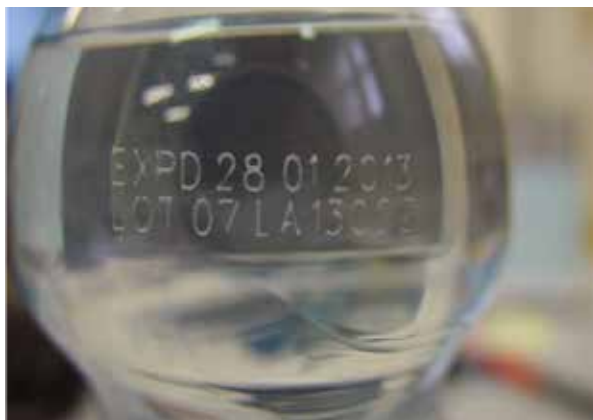

PET coding



Direct marking on cardboard

LASER APPLICATIONS

AUTOMOTIVE

1



2

3

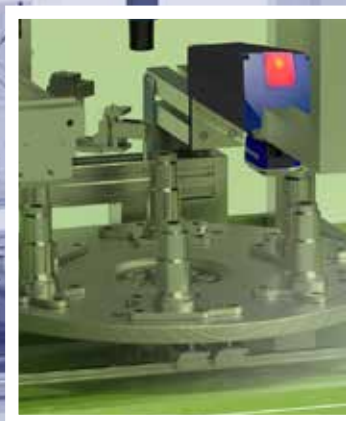

1. INSPECTION



Quality verification of parts during the manufacturing process

BENEFITS

- Higher, consistent and non-subjective product quality
- Early inspection prevents processing defective material and allows for the identification of bad parts that can be reworked
- Contactless inspection: no deformation of the inspected part
- Wide range of solutions: from low to very high resolution inspection
- IMPACT software delivers maximum inspection flexibility: part gauging, surface verification, assembling control, component positioning

2. PARTS TRACEABILITY & DPM



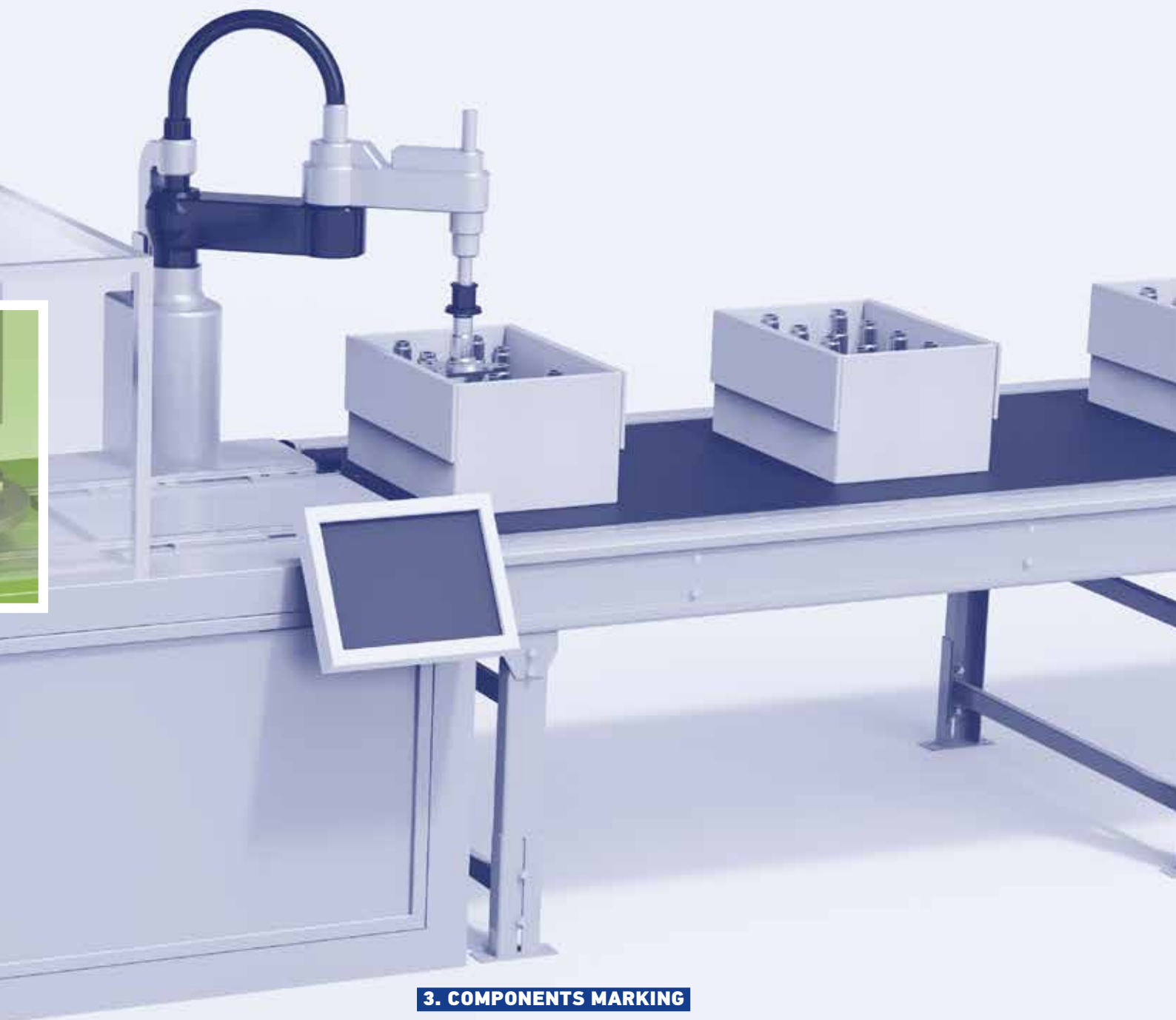

3. COMPONENTS MARKING

Direct Part Marking (DPM) of parts and components during assembly process

BENEFITS

- Direct part marking: no ink, no label
- Highly configurable serial numbering features including time/date, shift coding etc.
- Comprehensive 1D and 2D bar code library with advanced cell filling functions
- Built-in scripting capability for custom data formatting and integration with external database
- Deep engraving for end-of-life traceability
- Contactless operation : no mechanical stress or deformation on target



Parts are branded and personalized with manufacturer logos, graphics or quality marks.

BENEFITS

- Extreme flexibility: automatically change data on every mark, including logo, date, lot, order codes etc.
- Full range of options for drawing, importing and editing logos and graphics
- Comprehensive Windows® True Type font library including Unicode language support.
- Low-maintenance and cost-efficient
- Small and compact scanhead footprint for easy integration into existing production lines
- Minimal integration and setup time
- Built-in I/O for easy integration into automated production lines

ELECTRONICS

1 2



1. LASER CUTTING

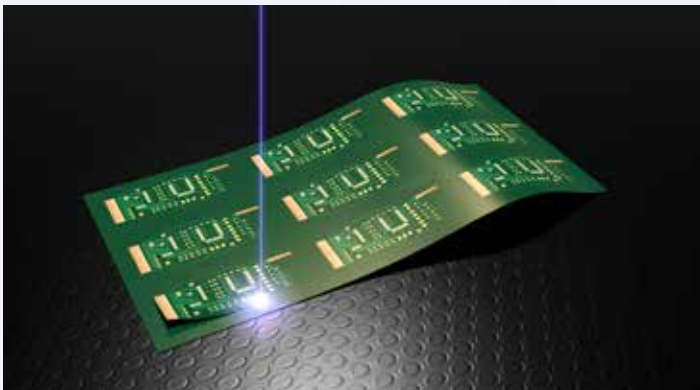

Stress free PCB cutting, drilling and depaneling for flex-rigid circuitry. Suitable for ITO/TCO processing and for cutting ceramic based materials

BENEFITS

- Low thermal footprint, no mechanical stress
- Rated for 24/7 operation
- Cost effective solution
- Broad range of materials

2. DPM READING AND CODE QUALITY VERIFICATION

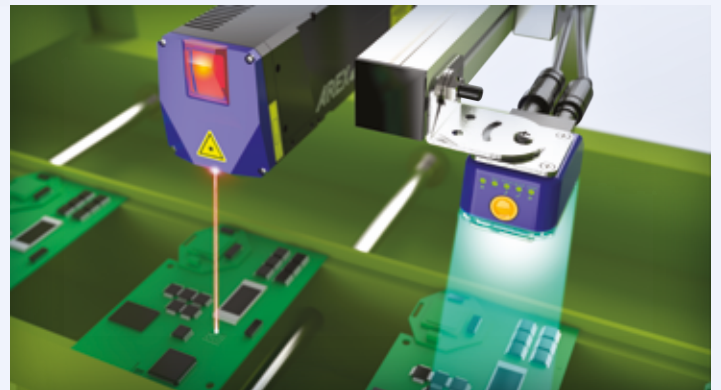

Tracking of a PCB is made easy through Direct Part Marking (DPM). 2D code validation after a laser marking station assures the correct information and 2D code readability.

BENEFITS

- YAG laser marking protection for mark-and-read solutions
- High density code reading on very small codes
- Code quality analysis for statistical process trending

3



4



3. LASER TRIMMING

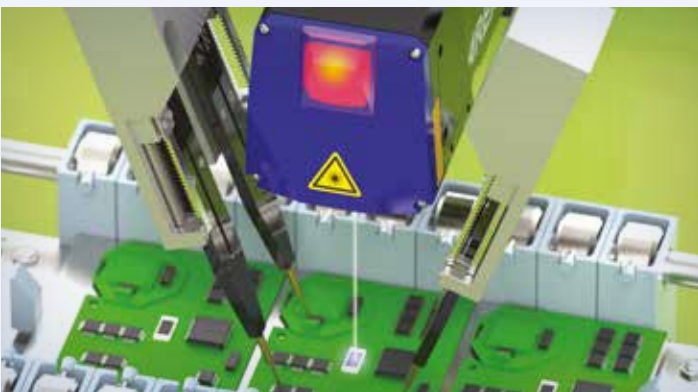

Active laser trimming of electronic circuits and SMD components and other SMD components

BENEFITS

- Low thermal footprint, reduced kerf width
- Accurate and precise beam positioning
- High speed ablation
- Easy integration and reduced setup time

3. WAFER MARKING

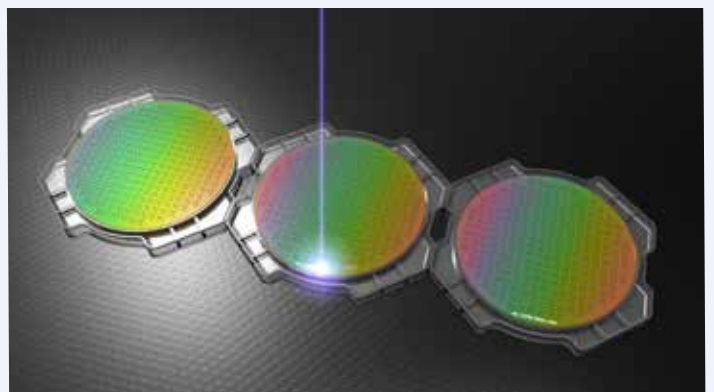

Stress & debris-free marking, by melting the silicon

BENEFITS

- Low thermal footprint, no mechanical stress
- Rated for 24/7 operation
- Cost effective solution
- Machine-readable marks

FOOD



1. LABEL MARKING & CHECKING

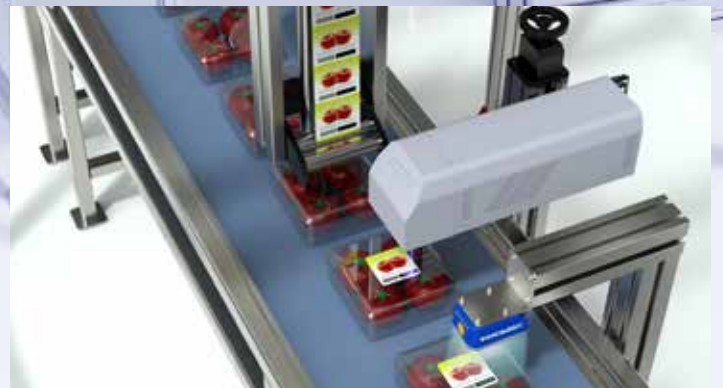

Product labels are marked with variable code, date, lot and MFG code. 1D or 2D codes are verified to check data consistency and guarantee product traceability.

BENEFITS

- Easy installation and reduced set-up time
- Low-maintenance and cost-efficient
- Non-contact, clean, environmentally friendly
- High speed Marking On-The-Fly

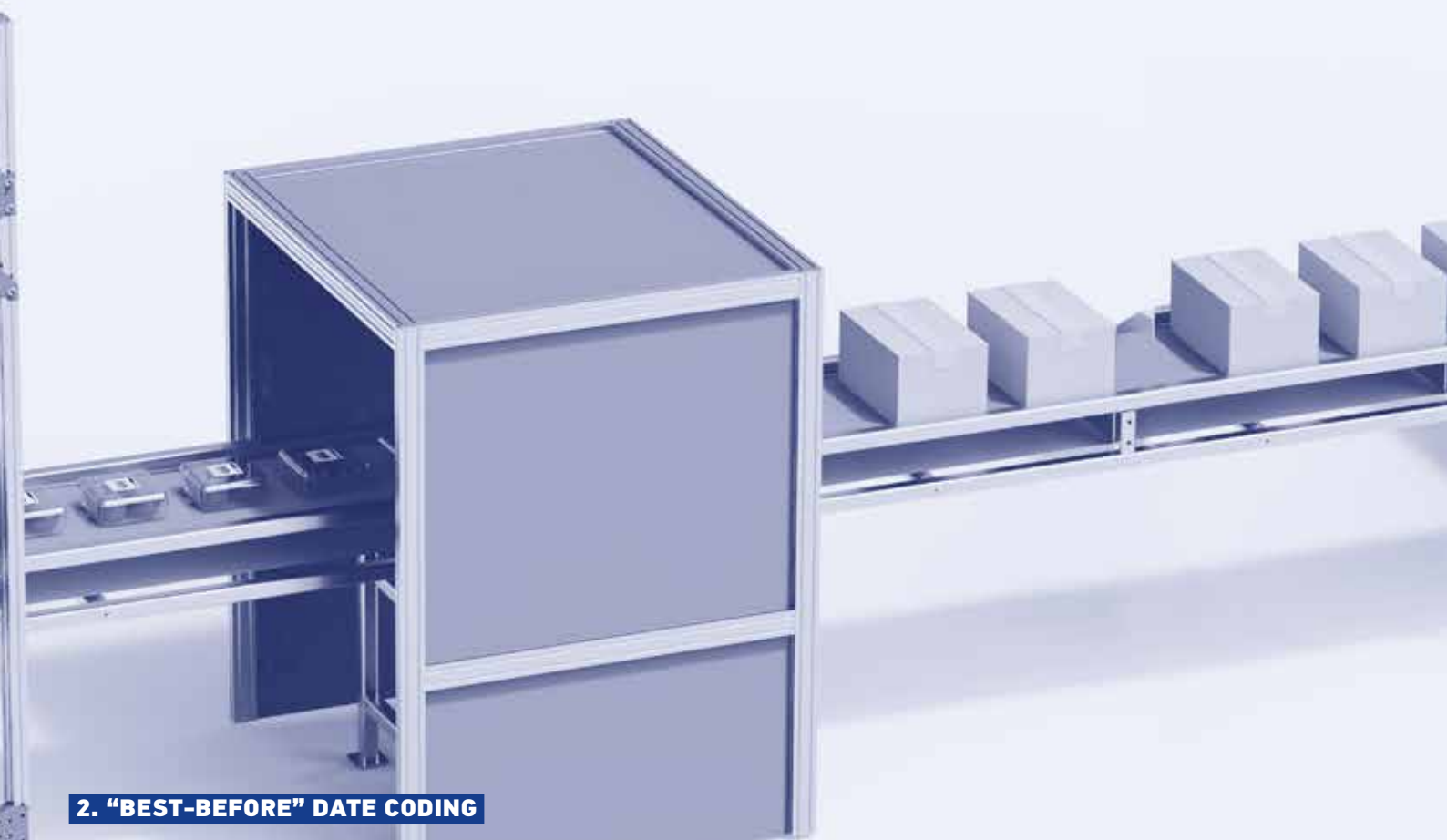

2. "BEST-BEFORE" DATE CODING



Laser markers remove the dark layer of a pre-printed label to create a permanent high contrast, high quality code. "Best Before" date, lot, manufacturing plant code and other information can be added after the labeling process.

BENEFITS

- Clean alternative to inkjet: no ink, solvent to refill, no drying time
- Environmentally friendly
- Very high quality, contrast and resolution
- Highly configurable serial numbering features including time/date, shift coding etc.
- Comprehensive 1D and 2D bar code library with advanced cell filling functions
- Built-in scripting capability for custom data formatting and integration with external database
- High speed, marking-on-the-fly
- Low total cost of ownership, reduced maintenance

PHARMACEUTICAL



1. CAP INSPECTION



The pharmaceutical industry requires high performance solutions for product inspection, coding and tracking. This inspection ensures the product quality by verifying the bottle cap is present and applied correctly. Normally, this inspection is performed at high rates of speed prior to the sealing and final packaging process where visual inspection is not possible without reopening the sealed package.

BENEFITS

- High speed, high accuracy quality control
- Full product traceability
- Certified product integrity
- Image and data archiving for quality reporting

2. LASER CODING AND VERIFICATION



LASER CODING

Critical variable product information is permanently marked directly or on laser activated labels.

The combination of human readable data and 2D codes identifies the product, the manufacturer, the batch number and the expiration date.

CODE VERIFICATION

Checking for critical variable product information on labels to verify data consistency and maintain quality standards.

BENEFITS

- Complete label inspection: 1D/2D code and OCR reading
- Total control of product serialization
- Information readability verification

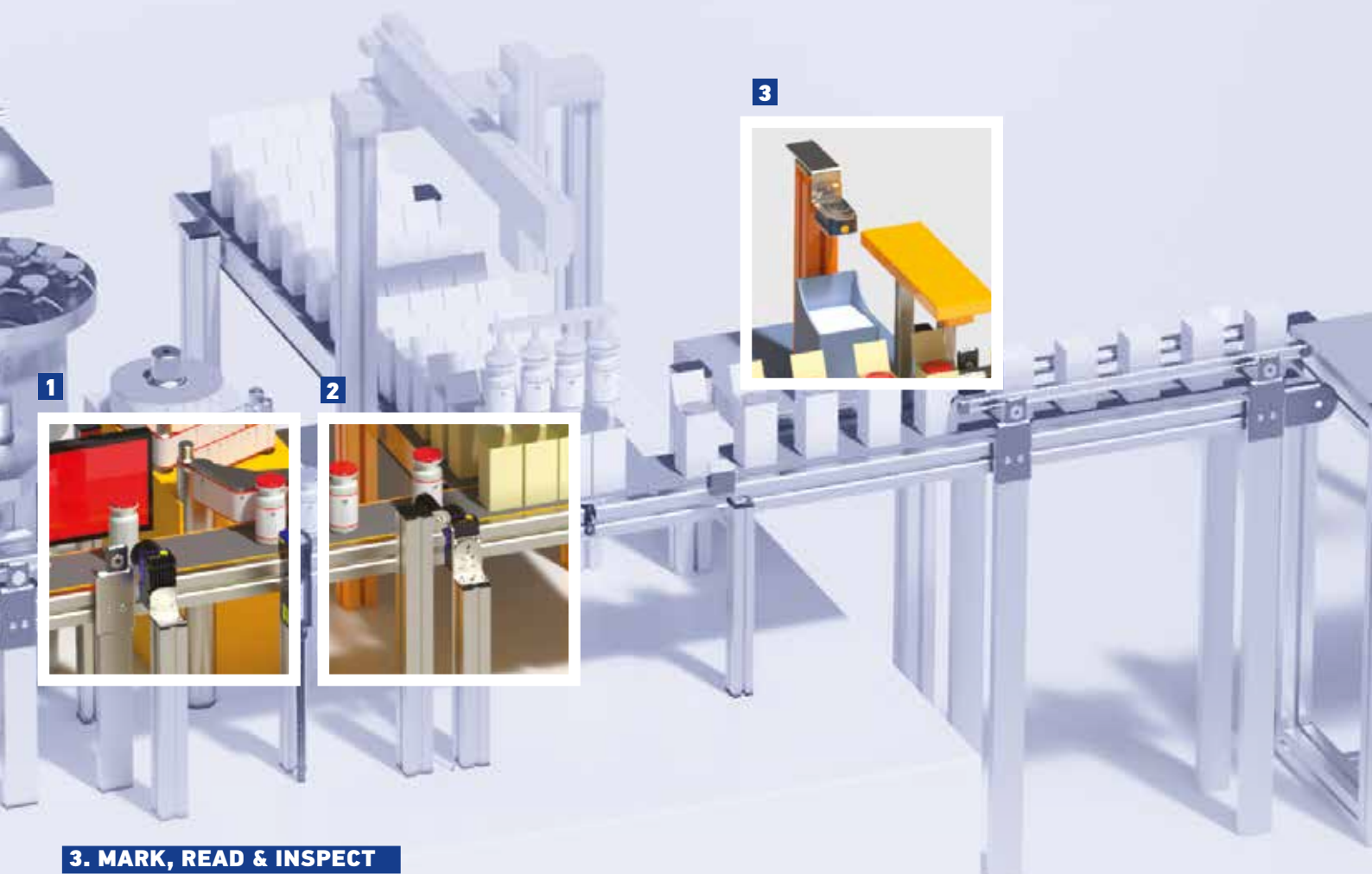

1

2

3



3. MARK, READ & INSPECT

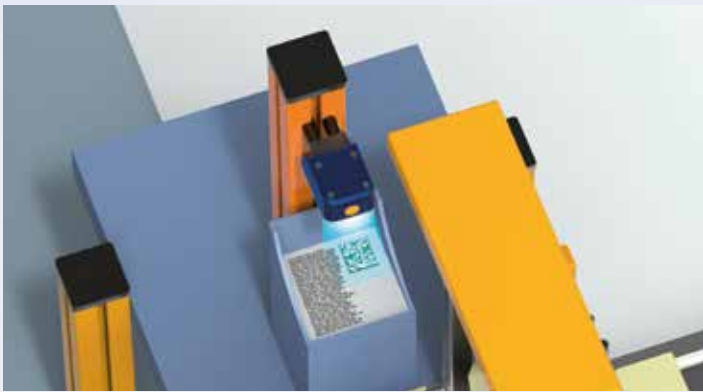

Complete integrated track, trace and control solutions with laser marking, inspection and bar code reading to guarantee accurate and efficient processes.

BENEFITS

- Correct match of drug, package and drug facts leaflet
- Full track&trace system
- Total traceability of every product component

LIGHTER SOFTWARE & LASER MARKING PRODUCTS

LIGHTER SOFTWARE

Thanks to its full graphical interface, **LIGHTER** joins advanced editing features with laser setup, controls and diagnostic for complete, flexible and ease of use laser marking system control.

LIGHTER SUITE is based on a quick-to-learn powerful WYSIWYG (What You See Is What You Get) graphical LASER EDITOR and an easy-to-use, LASER ENGINE.

This two-GUIs approach guarantee effective results in term of flexibility and operating speed.



LASER EDITOR: Advanced Editing Function

- Full Graphical interface, to easily design and edit any kind of marking layout.
- Built-in Property Browser for fast setting of all parameters
- Creates and edits texts, codes, imported vectorial graphics, logo, etc.
- Comprehensive and powerful coding library for 1D and 2D code (100+ code styles available)
- Direct import and edit of bitmap and vectors logo and graphics (BMP, PNG, GIF, JPG, SVG, TIF, PLT, DXF, DWG, AI, ...)
- Advanced filling and hatching features for objects and pattern structures with various styles.
- True Type Font (TTF) import tool, with advanced editing features (rounded text, slanted, compression etc.)
- Unicode language support
- Mark Preview – exact view of marking vectors.
- Clone function , array capabilities for IC marking,
- Gray tones marking

ADVANCED HATCHING FEATURES AND CAPABILITIES

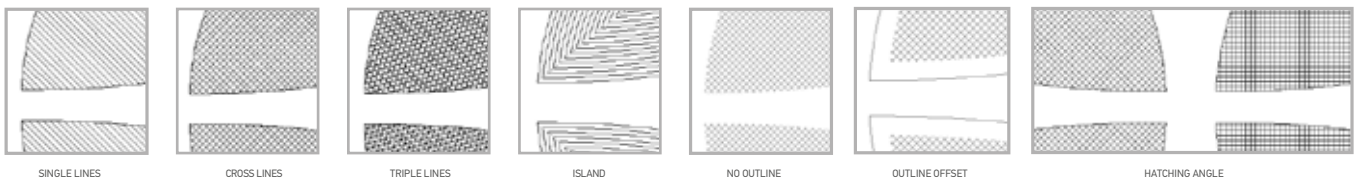

ABCDEFGHIJKLMNOPQRSTUVWXYZ - 1234567890
 ABCDEFGJKLMNPOQRSTUVWXYZ - 1234567890
 ABCDEFGJKLMNPOQRSTUVWXYZ - 1234567890
Script - A B c d e f g h i j k l m n o p q r s t u v w x y z - 1 2 3 4 5 6 7 8 9 0



احصائيات الموقع 搜索开放源代码
 한국어/조그말 अन्वेषी से हिन्दी





Embedded coding library supports linear, 2D, GS1 and composite symbologies. QR-Code, Datamatrix, are supported as well as other 100+ code styles.

AUTOMATION CAPABILITY

LIGHTER SUITE incorporates additional features to simplify automation and integration with automatic lines.

- Embedded Stepper Motor controller: up to 4 axes independent Mechanical Axis(- X, Y, Z and Rotary/indexer) at layout level
- User configurable general purpose I/Os with built-in I/Os monitor
- Marking-on-Fly (MOF) capabilities with Setup Wizard for easy set-up
- Sequence Editor to easily create sequential automated in a few clicks
- Powerful built-in counters and Global Variables Manager for serializing applications
- Built-in Material database
- Built in Script Engine for interaction with local or centralized database

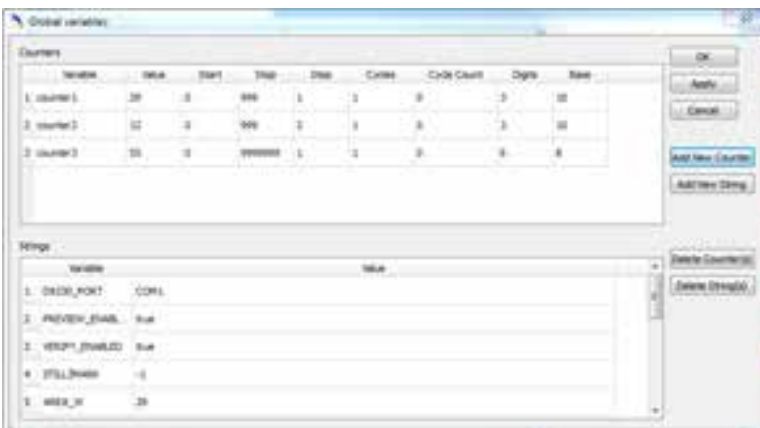

GLOBAL VARIABLES MANAGER



LASER TEST & I/O MONITOR

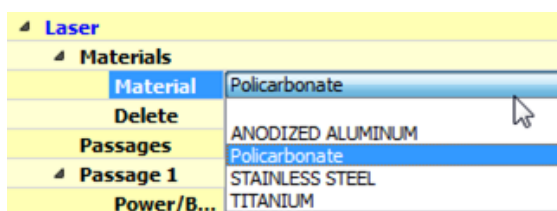

MATERIAL DATABASE

CONFIGURATION FLEXIBILITY

LIGHTER SUITE allows OEMs and Machine builders to develop a complete, cost effective, Laser Marking Station, based on embedded hardware and software resources, (STAND ALONE mode) or to design an advanced Laser Marking Solutions able to control a complete machinery over a simple Ethernet connection with supervisor computer (MASTER-SLAVE mode).

Full control, both in local and remote mode via Laser Editor GUI:

Local/Remote laser configuration, included MOF Wizard, laser diagnostic, I/O test

- Local/Remote I/O & axis control
- Local/Remote Automation Project control
- Local/Remote Active X support

EXAMPLE OF CONFIGURATION:

PRODUCTION MODE – UNATTENDED

Master Slave configuration is dedicated to remotely control one or more Laser Marking product over a simple Ethernet connection with a supervisor computer.

- Laser system can be installed without monitor or keyboard,
- Laser system is programmed from remote supervisor computer connected via LAN and work completely unattended.
- MASTER-SLAVE configuration is also useful in case of complex graphics editing or in case of interaction with other
- Vectorial Graphic Software (CorelDraw, Autocad, etc.) installed on a graphical workstation.

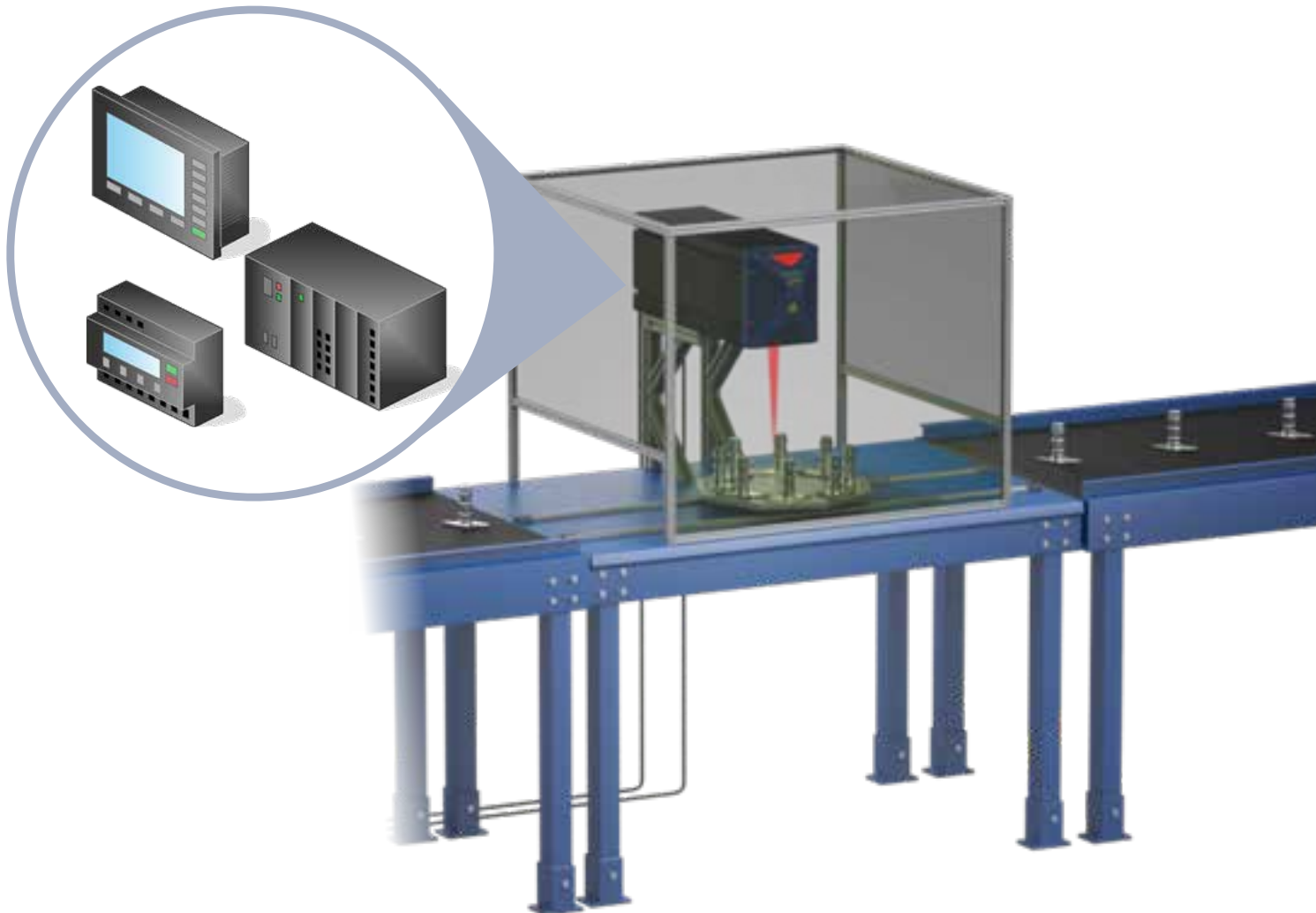

PRODUCTION MODE – UNATTENDED

PRODUCTION MODE is dedicated to repetitive production batches, where a simplified interface with limited editing capability is required.

Lighter Laser Engine provide only one easy GUI interface for laser control, marking task selection, AUTO/MANUAL marking mode, and full diagnostic.

Scripting Programmability allow integrators and End Users to create customized GUI and automated procedures to update layouts contents at runtime.



JOB-SHOP – INTERACTIVE

JOB SHOP – INTERACTIVE MODE is dedicated to small batches productions with the highest flexibility.

- Just one software interface for design, editing and laser control, including setup and configuration, allows laser users to quickly & friendly create, import, modify and engrave text, logos, codes bitmap etc.
- Manual and Automatic modes, axis control, laser test and laser configuration are easily accessible from Lighter Editor main screen as well as system status and diagnostic.

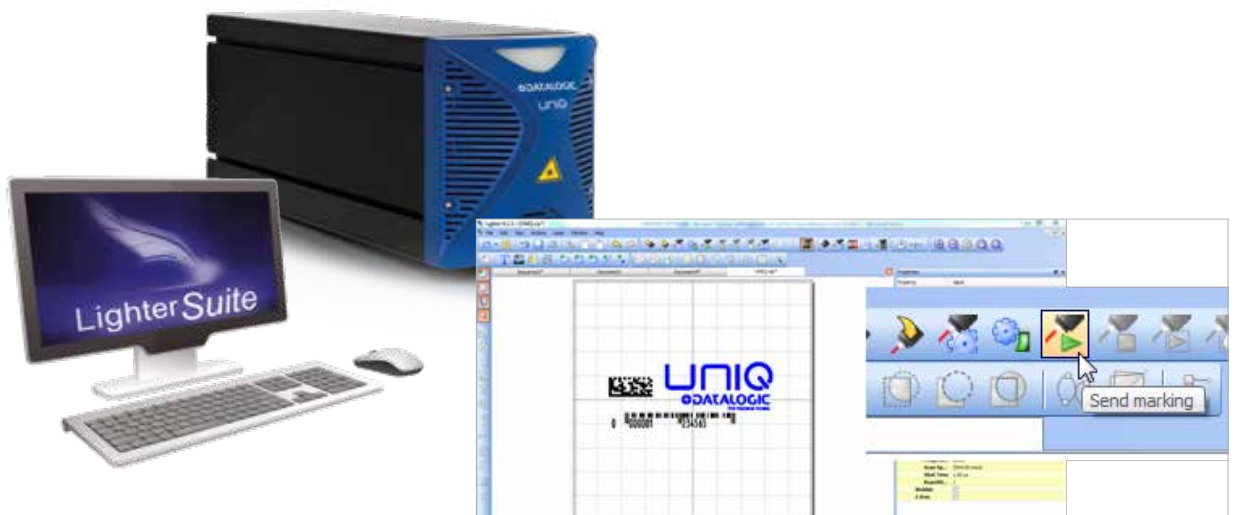

CONFIGURATION FLEXIBILITY

PROGRAMMABLE INTERFACES AND PERSONALIZATION CAPABILITIES

LIGHTER is scriptable this means that it can be easily integrated with legacy systems through a wide range of combinations of transmission media, protocols and architectures

LIGHTER 6 Suite integrates the IDE (Integrated Development Environment) providing to the users a full set of tools to be used for extremely flexible customization; The programming language is ECMAScript standard (also called JavaScript). With Project Editor it is possible:

- control the marking process with customized user's interface
- automatically create, modify, update and customize layouts at runtime
- create dedicated and custom GUI for efficient user interaction
- interact with other DLA's devices (Vision Sensors, Vision Systems, industrial ID reader)

Customized Laser Engine operative interface are easy and affective to automatize production process.

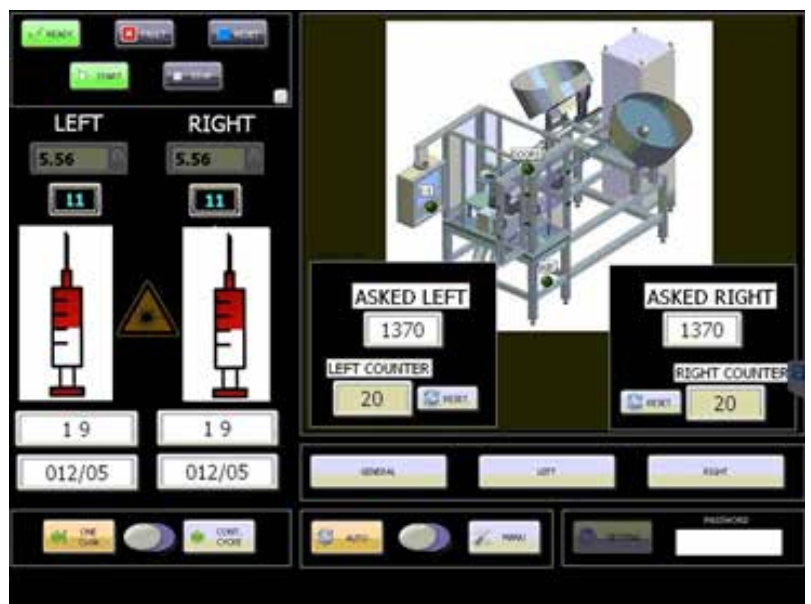
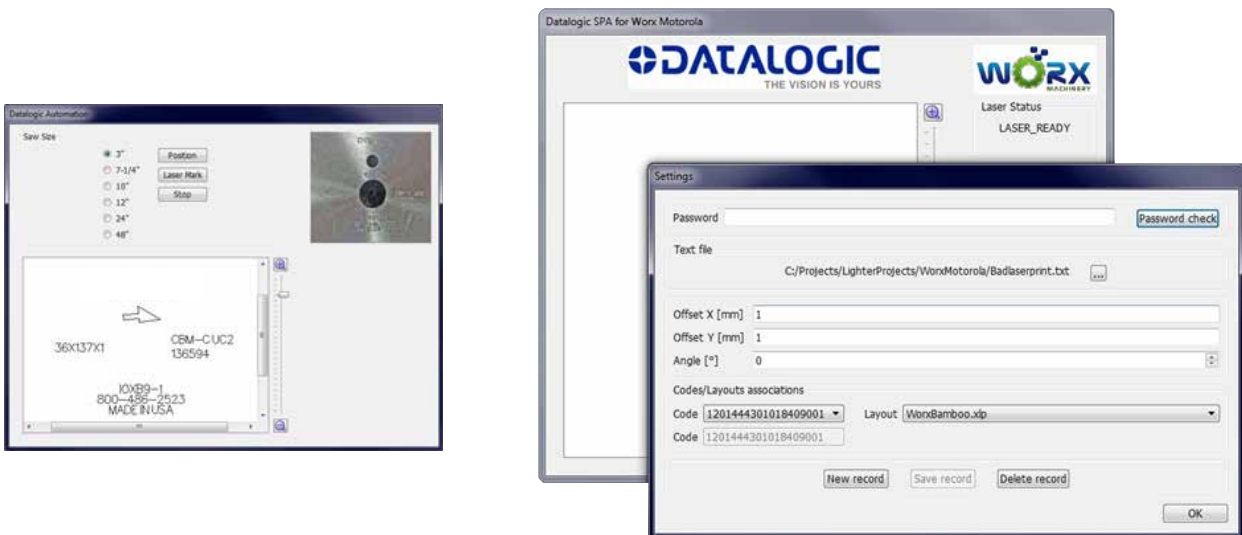

IP ActiveX allows OEM integrators and end-users to create customized Applications and User Interfaces via Ethernet.

MA.R.V.I.S. : MARK READ VERIFY INTEGRATED SOLUTION

Available with the LIGHTER software suite the new MARVIS (Mark Read Verify Integrated Solution) is the new Datalogic's solution for laser marking parts traceability.

LIGHTER MARVIS™ represents an important step-a-head in the MARK & VALIDATE application setting a new standard in term of ease integration and ease of use. Thanks to innovative approach LIGHTER MARVIS™ merges the capability to control both the full family of DATALOGIC Laser Markers and the entire family of MATRIX code readers, in a user friendly, simplified fully graphical interface.

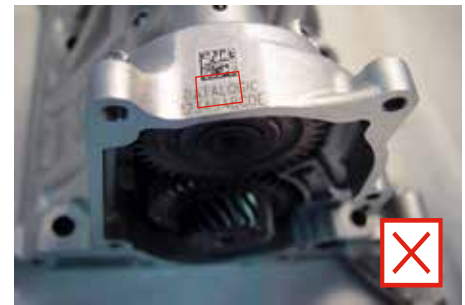
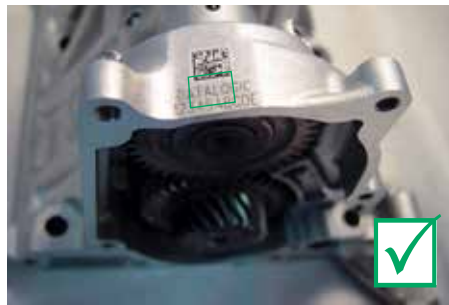

MARVIS: MARK & VALIDATE IN ONE CLICK



Object-Oriented Configuration

In the Lighter Suite, each object is associated with specific LASER parameters and READER configuration; loading a graphical layout will automatically retrieve and update laser and reader configurations. Product reconfiguration or format changes are as simple as loading a graphical layout.



Connectivity

The LIGHTER Suite allows OEMs and Machine builders to develop a complete and cost effective Laser Marking Station, based on embedded hardware and software resources (such as STAND ALONE mode) or to design an advanced Laser Marking Solution able to control machinery over a simple Ethernet connection with a supervisor computer (MASTER-SLAVE mode). Lighter Suite natively embeds Ethernet TCP/IP and EtherNet/IP protocols.

Advanced Editing Function



- Easily create, import and edit texts, shapes and logos
- One-click code generator for 1D and 2D symbologies
- Object-related Property Browser for fast adjustment of Marker and Reader parameters
- Imports Bitmap and Vector files (DXF, DWG, PLT, PDF, AI, SVG, BMP, JPG, PNG and TIFF...)
- Advanced filling featured with various laser-optimized patterns



Scripting programmability

The LIGHTER Suite integrates the IDE (Integrated Development Environment) providing the users with a full set of tools to be used for extremely flexible customization. The programming language is ECMAScript (also called JavaScript). With Project Editor it is possible to:

- Control the entire marking process
- Create and fully customize marking layout and its content at runtime
- Interact with local or centralized databases
- Create alternative customized interfaces
- Interact with Third Party devices

Integrated Configuration and Setup



- IP address discovery and connection management
- Dedicated Digital output for in-line parts selection
- Dedicated Digital input for deferred reader trigger
- Configurable images storage pool
- New Code Quality Training feature to automatically define code quality threshold from "Golden Sample"
- Patent Pending "Quality Grade Metric Profile" (QGP)

Runtime Production Statistics and Reports



Built-in validation statistics dashboard. Configurable log file with Quality Reporting and code images.

LASER MARKING PRODUCTS

AREX400 PULSED



AREX400 Series is the new generation of industrial grade laser markers based on fiber technology dedicated to direct part marking in manufacturing industries such as the Automotive, industrial Electronics, Tooling and precision mechanics.

Thanks to its exceptionally small and robust scanhead machined from solid aluminum Arex400 is unbeatable in tight space installation where small footprint is mandatory and reliability is a must.

Arex400 incorporates the new LASER GREENSPOT, the programmable visual indicator for immediate and effective visible process feedback directly on marking area, native support to micrometric displacement sensor, embedded communication protocols (TCP/IP, Ethernet IP, Profinet), built-in SLO (Safety Laser Off) and reduced noise level down to 65 dB.

AREX400 Series includes 4 different power level laser sources, spanning power and pulse width ranges on one unified platform.

Features & benefits

Quick installation and setup

AREX400 design dramatically simplifies and speeds up machine design and system integration thanks to Embedded Marking Controller (EMC) with LIGHTER Software Suite that ensures quick and easy installation, setup, control and system diagnostics even from remote via Ethernet TCP/IP. The Built-in step motors controller, totally integrated in software editor, greatly simplifies integration of rotary indexers, x-y tables and z axis

Applications











- Traceability: High contrast DPM (Direct Part Marking) coding
- Branding and Texturing: High resolution logos and graphics

Materials

- **Metals:** Stainless Steel, High-speed Steel, Carbide, Steel, Carbon steel, Copper, Iron, Ferrous Metals, Alloys, Magnesium, Aluminum, Brass, Gold, Silver, Platinum, Titanium ...
- **Coated / Painted Metals:** Anodized Aluminum, Painted metals, electrodeposited metal alloy coatings, etc.
- **Plastic:** Polycarbonate (PC) Polysulfone (PSU), Polyphenylene sulfide (PPS), Polystyrene (PC), Acrylonitrile Butadiene Styrene (ABS), Polyethylene terephthalate (PET) ...
- **Ceramics:** Aluminum Oxide (Al2O3), Zirconium Oxide (ZrO2), Aluminum Titanate (Al2TiO5), Silicon Carbide (SiSiC/SSiC), Zirconium Oxide (ZrO2)

industries

- Automotive
- Industrial electronics,
- Tooling and precision mechanics
- Visual communication,
- Medical/surgical tools and implants

PRODUCT FEATURES	BENEFITS
 Ultra-compact scan-head	Its ultra-compact form factor permits installation in tight spaces, dramatically simplifying setup saving space and costs during installation
 IP64 environmental protection	Robust design for durability even in harsh environment and demanding
 Lens protective cup	Protect expensive laser lenses from contaminations and scratches. The Lens cup can be easily cleaned, replaced without any downtime
 Robotic Grade conduit	Robotic grade, robust and flexible conduit, for reliable scanhead installation on robotic arms
 Datalogic 'Green Spot'	Visual indicator for immediate feedback of marking process, directly on the marking area.
 Marvis Ready: Mark & Validate in one click	Datalogic revolutionary solution to ensure error-proof traceability and zero-defect code marking.
 Built-in Safe Laser Off (SLO)	Integrated twin relay contactors to shut down laser power for ISO13849-1 compliant applications.
 UL LISTED	Tested and verified by UL (Underwriters Laboratories), one of the most recognized and trusted authority for product safety testing and certification.
 Displacement sensor support	NEW ACCESSORY - Automatically measure target position displacement from optimal focus position, and correct laser head position acting directly to (optional) Z-axis
	Cost effective, natively embedded communication protocols for simplified connectivity into complex systems and machines.

AREX400 M.O.P.A.

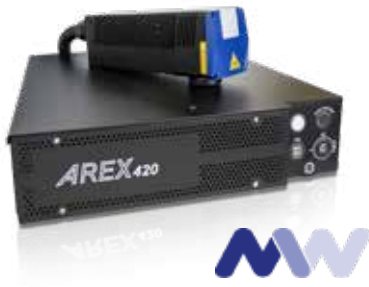

AREX400 is available with pulsed fiber source at power levels of 10, 20, 30, 50 Watts and with the 20 W MULTIWAVE M.O.P.A. fiber laser technology designed for maximum control of laser emission

The MOPA fiber source allows AREX420MW to mark on a wider range of materials with higher speed, better resolution and precision even on thermal sensitive materials.



Features & benefits

On top of the extraordinary features of AREX400 the MOPA source offers additional features and advantages:

- Linear power range from 0.1W to full power for precise marking even on sensitive materials
- Pulsewidth adjustment from 4 ns to 250 ns for best process optimization and repeatability
- High repetition rate up to 500KHz for faster marking and accurate texturing
- High peak Power for extended process capability.

Applications

- High contrast DPM (Direct Part Marking)
- Annealing
- High quality Branding
- Texturing
- Laser processing (selective coating removal, ablation, micro-drilling ...)

Processes

- High precision annealing & Color Marking on metals :
- "Black Marking" on anodized aluminum
- High quality appearance, aesthetical marking on plastic

Industries

- Automotive
- Aviation & aerospace
- Industrial electronics
- Mobile & semicon electronics
- Precision mechanics,
- Medical/surgical tools and implants

PARAMETER		AREX 410	AREX 420	AREX 420 MW	AREX 430	AREX 450
Nominal power	[W]	10	20	20	30	50
Peak power (max)	[kW]	10	10	≥ 10	10	10
Pulse energy	[mJ]	1,0	1,0	≥ 0.75	1,0	1,0
Modulation	KHz	2-200	2-200	20-500	2-200	2-200
Pulsewidth	ns	100	100	ADJ 4-250	100	100
Marking capabilities		Static, on the rotary indexer, on the fly (marking in motion); Extended-Layer (combination with X,Y Axis)				
Fiber length	[m]	3				
Integration		Built-in 4 axis step motors controller INPUTS: 10 programmable digital inputs OUTPUTS: 10 programmable digital outputs (NPN) Dedicated ports for Encoder, Photocell, MATRIX family Barcode Reader.				
Interfaces		6 x USB, 3 x Ethernet (PRO VERSION), 1 x RS-232, Digital I/O				
Protection rating		Head: IP64; Controller: IP31				
Power supply		100/240 VAC – 50/60 Hz – 400 W (MAX)				
Cooling		Low noise, Forced air				
Head dimensions/weight		89 mm x 96 mm x 311 mm – 3,5 kg				
Controller dimensions		427 mm x 111 mm x 435 mm – 17,5 kg				

F-THETA MODEL	MARKING AREA [MA] mm ²	MARKING AREA [MA] mm ²	FIXING DISTANCE [FD] mm	WORKING DISTANCE [WD] mm
	AREX 410 AREX 420 AREX 420 MW	AREX 430 AREX 450		
F = 100L	50 X 50	-	141	99
F = 160S	100X100	X	199	185
F = 160L	X	100X100	212	176
F = 254S	140X 140	X	305	285
F = 254L	180X180	170X170	372	301
F = 330L	220X 200	210X210	480	397
F = 420L	285X285	-	576	507

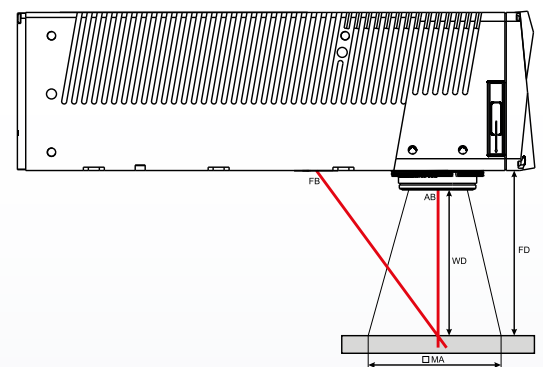

AREX400 configuration table

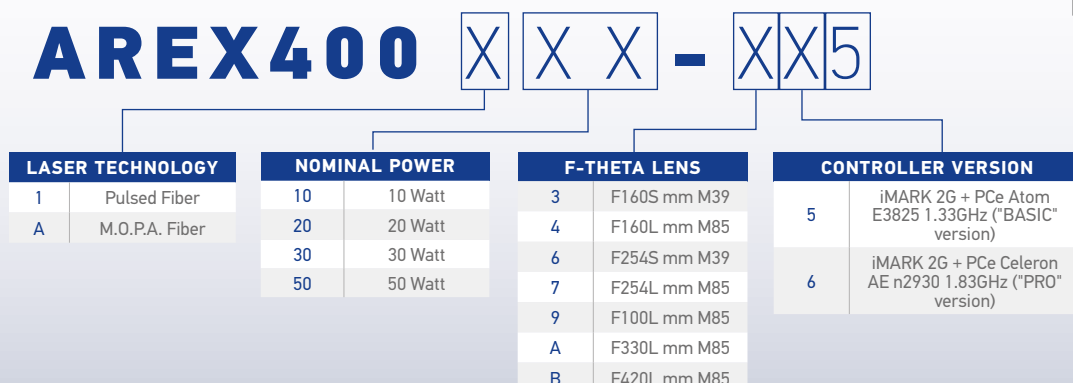

LASER MARKING PRODUCTS

UNIQTTM



UniQTM marker is a revolutionary and innovative approach to Fiber Laser Marking.

UniQTM fiber laser marker represent the perfect combination of a high performance fiber laser into a innovative, ultra-compact housing designed to provide an effective solution to the recent request of shorter, smaller production lines, in order to reduce footprint and floor area consumption.

Thanks to its advanced internal design, UniQTM laser marker does not need any low-ip grade external cabinet, controller or power supply, and is totally free from delivery fiber constraints such as fiber length and fiber bending limitations.

The IP54 rated innovative housing guarantees maximum protection even in harsh factory environments and industrial applications.

UniQTM laser marker works seamless with Datalogic's Lighter Suite, a powerful, quick and intuitive marking software, and is fully compatible with the latest Datalogic I/O interfaces.



Features & benefits

- Powerful 15W fiber laser source
- All-in-one, Fully integrated ultra-compact device
- Rugged IP54 rated housing
- All included: No external controller, no external power supply needed
- No fiber delivery constraints
- Built-in second generation EMC (Embedded Marking Controller)
- Great Money Vs Watt ratio
- Powered by Lighter software Suite

Main applications

Factory Automation

- **Automotive**
 - High Contrast DPM for traceability, quality control, testing & sorting
 - Label replacement, inkjet replacement.
 - High engraving depth for END –OF-LIFE traceability
- **Industrial Electronics**
 - High contrast marking on additivated plastic materials
 - High speed coding and branding on industrial electronic devices

Other

- **Medical & surgical tools**
 - Contactless and Clean Direct Marking Process for Branding & Personalization
 - Instant permanent marking: no drying time, no post processing, no solvent or additive
- **Precision Mechanics**
 - High precision marking with no mechanical stresses
 - Clear and precise annealing even on very small surface

PARAMETER		UNIQT
Wavelength	nm	1060 – 1080
Nominal power	w	15
Repetition rate range	kHz	15 - 100
Pulsewidth		120
Pulse energy	mJ	0.75
Peak power	kW	10
Marking capabilities		Standing, Rotary axis, On the fly (marking in motion)
Integration		Up to 4 mechanical axis driving capabilities (stepper motor) Up to 10 digital inputs and 10 digital output fully programmable dedicated connectors for Datalogic's Encoder and Photocell
Interface		Ethernet, RS 232, 4x USB
Power		100/240 VAC – 50/60 Hz
Cooling system		integrated air
Dimensions & weight - LxWxH		497x150 x183 mm - kg 10

VLASE SERIES: IR, GREEN, UV

VLASE SERIES now combines state-of-the-art YVO4 Solid State laser sources with the high flexibility and easy setup of the "ONE.RACK" embedded controller, providing machine builders, system integrators and end users a unified I/O interface for all three main laser marking technologies as well as only one control unit footprint and design. The high performance embedded controller provides easy operation in stand-alone configuration as well as sophisticated integration in master-slave configuration.



Features & benefits

- Compact, high performance laser resonator
- Detachable resonator & optical fiber
- High Peak power up to 60 kW
- Infrared, Green and UV on same platform
- Build-in embedded controller
- Ethernet, RS232, 4x USB ports
- Dedicated I/O for photocells and encoders
- 4 axis embedded controller

Main applications

Factory Automation

• Automotive

- Coating removal and paint stripping for NIGHT & DAY application
- High Contrast DPM for traceability, quality control, testing & sorting on high reflectivity materials.

• Electronics

- DPM for traceability to thermal sensitive, like silicon wafers, WLCSP, memory cards, ICs or high reflectivity materials like copper, gold and silver
- Branding and high resolution product identification

Other

• Healthcare

- Branding and high resolution product identification
- DPM for traceability, quality control, testing & sorting, quality selection.
- High quality marking on highly stable material for medical implants

• High Precision Machining

- Branding and high resolution product identification
- DPM for traceability, quality control, testing & sorting, wip track and control, quality selection



PARAMETER		VLASE IR 10	VLASE IR 20	VLASE GREEN 10	VLASE UV 3
Wavelength	nm	1064	1064	532	355
Nominal power	w	10	20	10	3
Repetition rate range	kHz	10 ÷ 100	20 ÷ 200	20 ÷ 100	20 ÷ 80
Pulse width	ns	15@10KHz	8@20KHz	10@50KHz	8@25KHz
Max pulse energy	mJ	0.48@10kKHz	0.55@20KHz	0.31@20KHz	0.12@30KHz
Peak power	kW	32@10KHz	65@20KHz	28@20KHz	14@25KHz
Marking capabilities		Standing, Rotary axis, On the fly (marking in motion)			
Integration		Up to 4 mechanical axis driving capabilities (stepper motor) Up to 10 digital inputs and 10 digital output fully programmable dedicated connectors Encoder and Photocell			
Interface		Ethernet, RS 232, USB			
Optical fiber		Detachable – 3 meters standard- 5 meters OPT			
Power supply		100- 240 VAC 50/60Hz – 600 W max			
Cooling system		Air cooled			
Resonator dimensions & weight		686x128 x166 mm - kg 7		704x153 x166 mm - kg 7	686x181x168 mm - kg 11
Controller dimension & weight		480x430x122 mm - kg 15			

LASER MARKING PRODUCTS

ULYXE



The Ulyxe product line provides ideal laser marking solutions for both stand-alone applications and industrial production lines.

The Ulyxe integrates a 6.5W DPSS laser marking system providing a cost effective and innovative design. With the best price/performance for plastics and metals, Ulyxe is the first choice in laser marking systems.

Features & benefits

- Air-cooled, reduced footprint ultra-compact design
- All-in-one design: scanning head, power driver & control electronics, marking controller, diagnostic and software suite
- Embedded, visible aiming beam and focus beam for fast and easy focus finding and simplified marking operations setup
- User-friendly touch screen LCD display for monitoring and controlling laser status and functions
- Patented, high efficiency, laser resonator design
- Best price to performance ratio on the market

Main applications

Manual or low Throughput applications

- Automotive
- Label marking, paint stripping & coating removal
- Electronics
- Branding and coding of thermoplastic polymers for electronics industry
- Healthcare
- Branding and high resolution for medical devices and traceability for implants
- Tool industry
- Branding, personalization of high quality tools.

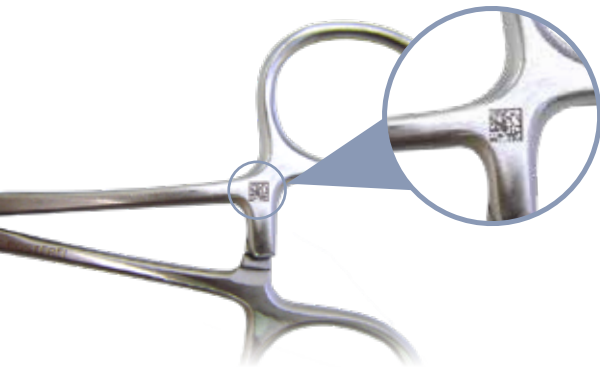

PARAMETER		ULYXE	ULYXE PL	ULYXE IMARK
Nominal average power	W	6	6	6
Wavelength	nm	1064	1064	1064
Repetition rate	KHz	10 – 100	10 – 100	10 – 100
Cooling system			Air cooled	
Display		YES, touch screen	NO, OPTIONAL	NO, OPTIONAL
Power supply			24 VDC – 300 W MAX	
Dimensions & weight (LxWxH)			410x145x123 - 7,8 Kg	

EOX SERIES



EOX is a family of CO2 Laser Markers for laser coding and marking applications. EOX offers high quality permanent marking on a wide range of materials like paper, carton, wood, plastics, painted or coated metals, and many other organic materials. Combining excellent laser beam quality and an advanced control unit, EOX is suitable for accurate industrial traceability, branding and coding applications. Based on the Embedded Marking Controller Platform (EMC), flexible “Stand Alone” or “Master –Slave” control modes and provides axis control as well as dedicated photocell / encoder ports for marking-on-the-fly (MOF). Thanks to its low operating cost, long lifetime and minimal maintenance, EOX provides a reliable and clean technology for industrial marking and coding applications.

Features & benefits

- Air-cooled, reduced footprint
- All-in-one design: scanning head, power & control electronics, marking controller, diagnostics and software suite
- Embedded visible aiming beam and focus beam for fast and easy focus setup and marking operation
- High resolution marking

Main applications

- General Marking
Label marking, paint stripping & coating removal, kiss-marking and perforating labels
- Electronics
PCB marking and coding, ceramic component marking, alumina marking
- Healthcare
Branding and coding containers
- Food
Direct, high contrast marking on food (cheese, bread, eggs, fruits, vegetables ...)
- Packaging
Marking coated paper, inked paperboards, film cutting and perforating

PARAMETER		EOX 10	EOX 30
Nominal average power	W	10	30
Wavelength	nm	10600	
Marking capabilities		Static, Rotary axis, On the fly (marking in motion)	
Integration		Up to 4 mechanical axis driving capabilities (stepper motor) Up to 10 digital inputs and 10 digital output fully programmable dedicated connectors Encoder and Photocell to 75mt/min and 12.000 pcs/hour	
Aiming & focus beam		Class II Semiconductor laser @ 635 nm	
Cooling system		Air cooled	
Resonator dimensions & weight		180x185x634 mm kg 18	180x185x634 mm kg 18
Controller dimensions & weight		---	437x94x333 mm kg 9
Power supply		100 – 240 VAC 50/60 Hz	
Operating temperature range	C°	10 to 35	

LASER MARKING APPLICATION MAP

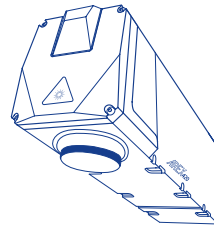

	units	AREX410	AREX420	AREX420MW	AREX430	AREX450
	W	10	20	20	30	50
	ns	100	100	4 - 250	100	100
	kW	10	10	12	10	10
	mJ	1	1	0,6	1	1
	nm	1070	1070	1070	1070	1070

INDUSTRY

<i>Automotive</i>		★★	★★★	★★	★★★	★★★
<i>Industrial Electronics</i>		★★★	★★★	★★★	★★★	★★
<i>Mobile Electronics</i>		★★	★★	★★★	★★	★★
<i>Semiconductor</i>		*	*	★★★	*	*
<i>Visual Communication & Promotional Gift</i>		★★★	★★★	★★	★★	★★
<i>Medical Devices And Implants</i>		★★	★★★	★★★	★★	★★
<i>Jewelry</i>		★★	★★★	★★	★★	★★★
<i>General Manufacturing</i>		★★	★★★	★★	★★★	★★
<i>Tooling</i>		★★	★★★	★★★	★★★	★★★
<i>Packaging</i>		*	*	*	*	*

APPLICATIONS

<i>Annealing</i>		*	★★★	★★★	★★★	★★★
<i>Color Marking</i>		*	*	★★★	*	*
<i>Engraving</i>		*	★★★	*	★★★	★★★
<i>Deep Engraving</i>		*	★★	*	★★★	★★★
<i>Surface Etching</i>		★★★	★★★	★★★	★★★	★★★
<i>Coating Ablation</i>		★★	★★★	★★★	★★★	★★
<i>Coating Removal (Night & Day)</i>		*	★★	★★★	★★	★★
<i>Bleaching</i>		★★★	★★★	★★★	★★★	★★
<i>Blackening</i>		★★★	★★★	★★★	★★★	★★
<i>Foaming</i>		★★★	★★	★★★	★★	★★
<i>Subsurface Engraving</i>		*	*	★★	*	*
<i>Texturing</i>		★★	★★★	★★★	★★	★★

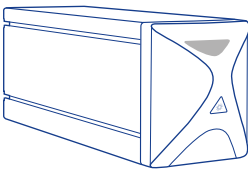
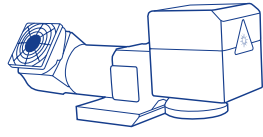
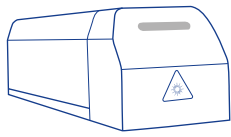
						
UNIQ	VLASE 10	VLASE 20	VLASE GREEN 10	VLASE UV 3	EOX 10	EOX 30
15	10	20	10	3	10	30
100	15	8	10	8		
7,5	32	65	28	14		
0,75	0,5	0,6	0,3	0,1		
1070	1064	1064	532	355	10600	10600
***	**	***	**	***	**	**
***	***	***	***	***	***	***
**	**	**	***	***	***	***
*	*	*	***	***	***	***
***	***	***	*	*	*	*
***	***	***	***	*	*	*
**	**	***	*	*	*	*
***	***	***	*	*	*	*
***	***	***	*	*	*	*
*	*	*	*	*	***	***
***	***	***	*	*	*	*
*	*	**	*	*	*	*
***	*	**	*	*	***	***
**	*	**	*	*	***	***
***	***	***	***	***	*	*
***	***	***	***	***	*	*
**	***	***	**	**	*	*
***	***	***	**	**	*	*
***	**	***	**	**	*	*
***	***	**	**	**	*	*
*	*	***	*	*	*	*
***	***	***	***	***	**	**

LASER MARKING MATERIALS MAP

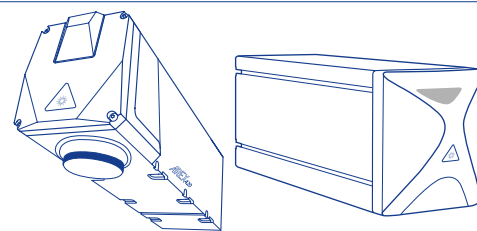

MATERIALS			AREX400 - UNIQ
PLASTIC			
<i>Acrylonitrile Butadiene Styrene</i>	ABS	Polylac Tairilac Terluran	★★★
<i>Epoxy</i>			★★★
<i>High-density polyethylene</i>	HDPE		★★★
<i>Polyoxymethylene</i>	POM		★★★
<i>Polyamide</i>	PA	Nylon®	★★★
	PA6	Arconyl®	
	PA66	Workmid®	
	PA66GF30	Vydyne®	
	PA66GF25	Technyl®	
	Natural PA66		
<i>Polybutylene terephthalate</i>	PBT		★★★
	PBT GF30		
<i>Polycarbonate</i>	PC	Lexan®	★★★
		Makrolon®	
<i>Polyether ether ketone</i>	PEEK		★★
<i>Polyester</i>	PES	Thermolite®, Polarguard®	*
<i>Polyethylene</i>	Natural PE	Mylar®	
<i>Polyethylene terephthalate</i>	PET	Mylar®	*
		Arnite®	
		Ertalyte®	
		Dacron®	
<i>Polyetherimide</i>	PEI-GF20		★★★
<i>Polyimide</i>	PI	Kapton®	*
<i>Polymethyl-methacrylate</i>	PMMA	Plexiglas®	★★
<i>Polyoxymethylene Black</i>	POM	Delrin®	★★★
<i>Polyoxymethylene White</i>			
<i>Polypropylene</i>	Natural PP		
<i>Polystyrene</i>	PS		★★★
<i>Polyurethane</i>	PUR		
<i>Polyvinil Chloride</i>	PVC		★★★
<i>Silicone</i>			*
<i>Styrene-acrylonitrile resin</i>	SAN	Tyrl®	*
<i>Urea</i>			
CERAMICS			
<i>Aluminum Oxide</i>	Al2O3	Alumina	★★
<i>Tungsten Carbide</i>	WC		★★
<i>Silicon Carbide</i>	SiSiC/SSiC	Rocar®	
<i>Silicon Nitride</i>	Si3N4		

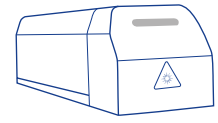
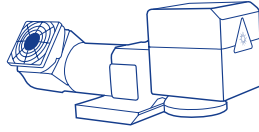
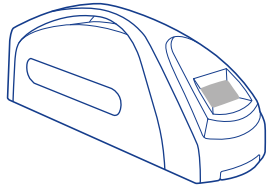

VLASE IR - ULYXE	VLASE - GREEN	VLASE - UV	EOX
***			*
***			***

***			***
***		***	
**		***	
***			**
**	**	***	*
*		**	*
	*	**	
			**
***	***	***	
*	**		*
**	***	***	*
***			*
			*
	*	**	
***			*

***		***	***
*	**	***	**
*	**	**	*
		**	**
	*		
	*		
	*		

MATERIALS			AREX400 - UNIQ	VLASE IR - ULYXE
METALS				
<i>Chromium</i>			★★★	★★★
<i>Cobalt</i>			★★★	★★★
<i>Copper</i>			★★	★★
<i>Gallium</i>			★★★	★★★
<i>Gold</i>			★	★★
<i>Indium</i>			★★★	★★★
<i>Iron</i>			★★★	★★★
<i>Lead</i>			★★	★★
<i>Lithium</i>			★★★	★★★
<i>Magnesium</i>			★★★	★★★
<i>Molybdenum</i>			★★★	★★★
<i>Neodymium</i>			★★★	★★★
<i>Nickel</i>			★★★	★★★
<i>Palladium</i>			★★★	★★★
<i>Rodium</i>			★★★	★★★
<i>Samarium</i>			★★★	★★★
<i>Silicon</i>			★★	★★★
<i>Silver</i>			★	★★
<i>Tin</i>			★★★	★★★
<i>Tungsten</i>			★★★	★★★
<i>Vanadium</i>			★★★	★★★
<i>Zinc</i>			★★★	★★★
<i>Zirconium</i>			★★★	★★★
METAL ALLOYS				
<i>Aluminum Alloy</i>	1xxx- 8xxx	Anticorodal®, Ergal®,	★★★	★★★
	2xxx	Avional®, Duraluminum®	★★	★★
	1xxx- 8xxx	Zama®	★★	★★
<i>Brass</i>			★★★	★★★
<i>Stainless steel</i>			★★★	★★★
<i>Steel</i>			★★★	★★★
<i>Tungsten carbide</i>	WC		★★★	★★★
<i>Titanium alloy</i>	Ti-6Al-4V, Ti-6Al-7Nb		★★★	★★★
OTHERS				
<i>Glass</i>				
<i>Glass Pyrex</i>				
<i>Graphite</i>				
<i>Leather</i>				
<i>Paper</i>				
<i>Quartz</i>				
<i>Rubber</i>				
<i>Sapphire</i>				
<i>Stone</i>				
<i>Textiles</i>				

ACCESSORIES

Remote start footswitch



Optional accessory dedicated to hands-free operations in manual loading machine and semi-automatic system

- Rugged, long life cast-iron FootSwitch
- Non-skid base and 3 meters cable.
- M12 connector to Laser Unit

985350035	REMOTE START FOOT SWITCH
------------------	--------------------------

High resolution Displacement Measuring Sensor



Automatically measure target position displacement from optimal focus position, and correct laser head position acting directly to (optional) Z-axis
simplified connectivity (dedicated "DEVICE PORT")
complete kit, with mounting brackets and protective YAG filter.

985350037	MICROMETRIC DISTANCE SENSOR KIT AREX 400
985350036	MICROMETRIC DISTANCE SENSOR KIT AREX

Protective lens cup



PROTECTIVE LENS CUP

Easy to install, easy to replace, simplify preventive/periodic maintenance cleaning operation on F-theta lens and allow no-stop operations.

- Ensure complete IP64 protection
- Suitable for F160S and F254S lenses

985350038	M39 F-THETA PROTECTIVE CAP
------------------	----------------------------

MARVIS add-on kit

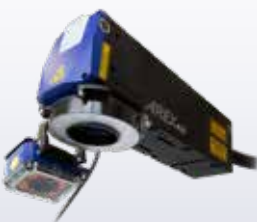

Complete Mark & Validate kit, with ID Reader, mounting bracket, wiring set, SW license and external ring light

937600122	MARVIS ADD-ON FOR AREX/VLASE
937600123	MARVIS ADD-ON FOR UniQ
937600124	MARVIS ADD-ON FOR AREX400

ACCESSORIES

I/O Signal Conditioning Board



NEW Isolated Digital I/O Signal conditioning board with DIN-rail adapter.

- “Clean contacts” output
- “Clean Opto-isolated inputs”
- Pass-through Command Box Connector

985330032

RELE INTERFACE

Command Box DB25-to-free leads cable



3 meters cable DB25 Male-to-free-leads for simple and easy field connection to PLC or control system.

- Connect laser units, quickly and easily onsite without having to solder or crimp contacts.
- Individually labelled leads

985350032

SUB-D 25 PINS - TO FREE LEADS CABLE 3M

Control box



Ready to use remote pendant for UNIQ AREX VLASE.

- 2 meters cable
- Key & enable selectors
- START STOP push-buttons
- READY, BUSY, END, ALARM led signals
- Available also for ULYXE series

985330031

CONTROL BOX STANDARD (AREX UNIQ VLASE)

985330001

ULYXE BASIC CONTROL BOX (ULYXE ONLY)

ACCESSORIES COMPATIBILITY

Fumes extractor



- Twin filtration system particles + activated carbon.
- Ultra compact specialty laser fumes extractor
 - Max air flow 190 m3/h
 - Adjustable air flow
 - Dimensions 400x350x500 mm (WxDxH)

Suitable for:

- Metal Marking
- Wood, paper marking
- Rubber, Plastic marking

985340035	FUMES EXTRACTOR
------------------	-----------------

Starter kit for marking on the fly

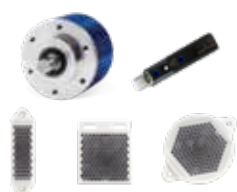

Ready to use rotary encoder and photocell for Marking on the fly application, complete with dedicate wiring for AREX, UNIQ VLASE connections

KIT includes:

- ENCODER 5000 PPR - ENC58-S10 – 5000 –M12
- Photocell S51 –PA-5-B01-PK
- Selection of prismatic reflectors (48, 18x54, 51 x64 mm)
- Cable kit for direct connection with AREX, UNIQ, VLASE

985330027	PF KIT ENCODER PHOTOCELL FOR MOF
------------------	----------------------------------

MODEL	DESCRIPTION	AREX400	AREX V3	VLASE	UNIQ
937600124	MARVIS ADD-ON FOR AREX400	✓			
937600122	MARVIS ADD-ON FOR AREX / VLASE		✓	✓	
937600123	MARVIS ADD-ON FOR UNIQ				✓
93ACC1918	MARVIS SW LICENCE	✓	✓	✓	✓
93A051394	MARVIS LED LIGHTLING ID 50 mm - WHITE	✓	✓	✓	✓
93ACC1916	MARVIS MOUNTING BRACKET FOR AREX400 & M300N	✓			
93ACC1914	MARVIS MOUNTING BRACKET FOR AREX & M300N		✓		
93ACC1915	MARVIS MOUNTING BRACKET FOR UNIQ & M300N				✓
985350035	REMOTE START FOOT SWITCH	✓	✓	✓	✓
985330032	RELE INTERFACE	✓	✓	✓	✓
985330031	CONTROL BOX STANDARD	✓	✓	✓	✓
985350038	M39 F-THETA PROTECTIVE CAP	✓			
985350037	MICROMETRIC DISTANCE SENSOR KIT AREX 400	✓			
985350036	MICROMETRIC DISTANCE SENSOR KIT AREX/VLASE/UNIQ		✓	✓	✓
985350039	RACK HANDLES AREX 400	✓			
985340035	LAS 160 FUME EXTRACTOR	✓	✓	✓	✓
985350032	DB25-TO-FREE LEADS CABLE	✓	✓	✓	✓
985330027	STARTER KIT FOR MARKING ON THE FLY	✓	✓	✓	✓

LENS SPECIFICATION

F-THETA LENS & ACCESSORIES

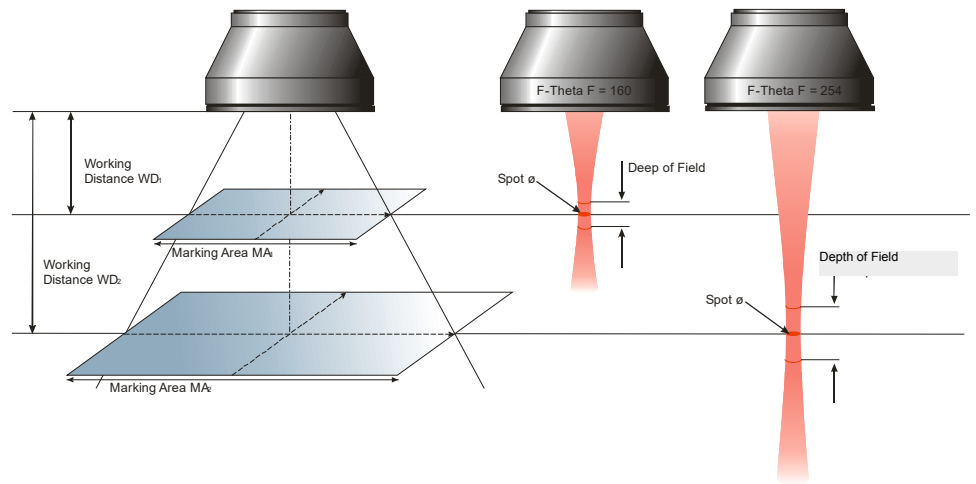

1064 nm F-THETA LENS & ADAPTER

F-THETA LENS	WORKING AREA	WORKING DISTANCE	SPOT Ø (Typ)	LENS THREAD	LASER PRODUCT		
MODEL	[WA] mm ²	[WD] mm	µm	mm	AREX 410 AREX 420 AREX 420MW UniQ	AREX 430 AREX 450	VLASE IR ULYXE
F100L	50 x 50	99	~ 50	M85x1,0	✓	X	✓
F 160S	100 x 100	183	~ 80	M39x1.0	✓	X	✓
F 254S	140 x 140	280	~ 100	M39x1.0	✓	X	✓
F 160L	110 x 110	176	~ 70	M85x1,0	*	✓ (100 x 100)	✓
F 254L	180 x 180	296	~ 90	M85x1.0	*	✓ (170 x 170)	✓
F 330L	220 x 220	388	~ 120	M85x1.0	✓	✓ (210 x 210)	✓
F 420L	285 x 285	494	~ 160	M85x1.0	✓	--	✓

* not available on all product configurations

532 nm & 355 nm F-THETA LENS

F-THETA LENS	WORKING AREA	WORKING DISTANCE	SPOT Ø (Typ)	LENS THREAD	LASER PRODUCT	
MODEL	[WA] mm ²	[WD] mm	µm	mm	VLASE-Green	VLASE-UV
F 160L	110 x 110	176	~ 40	M85x1.0	✓	--
F 254L	180 x 180	288	~ 60	M85x1.0	✓	--
F 103T**	60 x 60	135	~ 30	M85x1.0	--	✓
F 160L	110 x 110	197	~ 35	M85x1.0	--	✓

**Telecentric F-theta Lens

10.600 nm ZINC SELENIDE CO2 F-THETA LENS

F-THETA LENS	WORKING AREA	WORKING DISTANCE	SPOT Ø (Typ)	LENS THREAD	LASER PRODUCT	
MODEL	[WA] mm ²	[WD] mm	µm	mm	EOX-10	EOX-30
F 100	70 x 70	96	~ 250	Ø 48	✓	✓
F 200	140 x 140	196	~ 370	Ø 48	✓	✓

When handling optics, one should always wear gloves. This is especially true when working with zinc selenide, as it is a hazardous material. For your safety, please follow all proper precautions, including wearing gloves when handling these lenses and thoroughly washing your hands afterward.



Rev. 06. 09/2021



9C514600E

Product and Company names and logos referenced may be either trademarks or registered trademarks of their respective companies. We reserve the right to make modifications and improvements.

www.datalogic.com