

# Gryphon™ 2D Family Gryphon I GD/GBT/GM4500

## PRODUCT REFERENCE GUIDE



General Purpose Handheld  
Area Imager Bar Code Reader

## **Datalogic S.r.l.**

Via S. Vitalino, 13  
40012 Calderara di Reno (BO)  
Italy  
Tel. +39 051 3147011  
Fax +39 051 3147205

### **© 2011-2023 Datalogic S.p.A. and /or its affiliates**

All rights reserved. Without limiting the rights under copyright, no part of this documentation may be reproduced, stored in or introduced into a retrieval system, or transmitted in any form or by any means, or for any purpose, without the express written permission of Datalogic S.p.A. and/or its affiliates.

Owners of Datalogic products are hereby granted a non-exclusive, revocable license to reproduce and transmit this documentation for the purchaser's own internal business purposes. Purchaser shall not remove or alter any proprietary notices, including copyright notices, contained in this documentation and shall ensure that all notices appear on any reproductions of the documentation.

Electronic versions of this document may be downloaded from the Datalogic website ([www.datalogic.com](http://www.datalogic.com)). If you visit our website and would like to make comments or suggestions about this or other Datalogic publications, please let us know via the "Contact" page.

## **Disclaimer**

Datalogic has taken reasonable measures to provide information in this manual that is complete and accurate, however, Datalogic shall not be liable for technical or editorial errors or omissions contained herein, nor for incidental or consequential damages resulting from the use of this material. Datalogic reserves the right to change any specification at any time without prior notice.

## **Trademarks**

Datalogic and the Datalogic logo are registered trademarks of Datalogic S.p.A. in many countries, including the U.S.A. and the E.U.

Gryphon is a trademark of Datalogic S.p.A. and/or its affiliates, registered in the U.S. The Bluetooth word mark and logos are owned by Bluetooth SIG, Inc. and any use of such marks by Datalogic S.p.A. and/or its affiliates is under license. All other trademarks and brands are property of their respective owners.

## **Patents**

See [www.patents.datalogic.com](http://www.patents.datalogic.com) for patent list.

## **Software Version**

This manual refers to the following software versions and later:

GD4500: 610149114

GM4500: 610149419

GBT4500: 610149319

WLC4090-BASE-WIRELESS-CHARGER: 610150119

WLC4090-BT-BASE-WIRELESS-CHARGER: 610150019

# TABLE OF CONTENTS

---

<b>PREFACE</b> .....	<b>XIII</b>
<b>About this Manual</b> .....	<b>xiii</b>
<b>overview</b> .....	<b>xiii</b>
Manual Conventions .....	xiv
<b>Technical Support</b> .....	<b>xiv</b>
Support Through the Website .....	xiv
Reseller Technical Support .....	xiv
<b>CHAPTER 1. INTRODUCTION</b> .....	<b>1</b>
<b>About the Reader</b> .....	<b>1</b>
<b>Using the Gryphon™ I GD4500 Reader</b> .....	<b>1</b>
<b>Battery Safety</b> .....	<b>2</b>
<b>Programming the Reader</b> .....	<b>4</b>
Configuration Methods .....	4
Programming Bar Codes .....	4
Datalogic Aladdin™ .....	4
<b>CHAPTER 2. SETUP</b> .....	<b>5</b>
<b>Unpacking</b> .....	<b>5</b>
<b>Setting Up the Gryphon™ GD4500 reader</b> .....	<b>5</b>
<b>Connect Host Interface</b> .....	<b>6</b>
RS-232 Serial Connection .....	6
Keyboard Wedge Connection .....	7
USB Connection .....	7
<b>Stand Installation</b> .....	<b>8</b>
Hands-Free Stand/Holder .....	8
<b>Setting Up the Gryphon™ GM/GBT4500 Reader</b> .....	<b>9</b>
<b>Positioning the Base Station</b> .....	<b>10</b>
Base Station Positions and Related Clips to be Used .....	10
<b>Reader, base station and LEDs Description</b> .....	<b>13</b>
<b>Connecting the Base Station</b> .....	<b>14</b>
Base Station Connection and Routing .....	14
Securing the DC Power Cord (Optional) .....	15
Host Connection .....	16
Power Connection .....	16
Disconnecting the Cable .....	16
<b>System and Network Layouts</b> .....	<b>17</b>
Stand Alone Layouts .....	17
<b>Using the GBT/GM4500 Reader</b> .....	<b>18</b>
Reader LEDs .....	18
<b>Using the WLC4090 Radio Base</b> .....	<b>19</b>
Radio Base LEDs .....	19
<b>Replacing the Battery Pack</b> .....	<b>20</b>
<b>Using the Gryphon™ I GD/GBT/GM4500</b> .....	<b>22</b>
<b>Linking the Reader</b> .....	<b>24</b>
Link Datalogic Devices to Base .....	24
Link Reader as Serial Device to a Bluetooth Host .....	24
Link Reader as HID device to a Bluetooth host .....	24

<b>Bluetooth Passkey or PIN Code Entry Request .....</b>	<b>25</b>
<b>Power Off .....</b>	<b>25</b>
<b>Interface Selection .....</b>	<b>26</b>
<b>Configuring the Interface .....</b>	<b>26</b>
<b>Customizing Configuration Settings .....</b>	<b>30</b>
Using the Programming Bar Codes .....	30
Datalogic Aladdin™ Utility .....	30
Interface Settings .....	30
Configuring Other Features .....	31
Software Version Transmission .....	31
Resetting the Product Configuration to Defaults .....	31
Restore Custom Default Configuration .....	31
Restore Factory Configuration .....	32
<b>CHAPTER 3. CONFIGURATION WITH BAR CODES.....</b>	<b>33</b>
<b>Configuration Parameters .....</b>	<b>33</b>
Interface Configuration: .....	33
Parameters common to all interface applications: .....	33
Symbology-specific parameters: .....	34
<b>GLOBAL INTERFACE FEATURES .....</b>	<b>35</b>
Host Commands — Obey/Ignore .....	35
USB Suspend Mode .....	35
<b>RS-232 INTERFACE .....</b>	<b>36</b>
RS-232 STANDARD SETTINGS .....	37
Baud Rate .....	37
Data Bits .....	38
Stop Bits .....	38
Parity .....	39
Handshaking Control .....	40
<b>RS-232/USB-COM INTERFACES .....</b>	<b>41</b>
RS-232/USB-COM SETTINGS .....	42
Intercharacter Delay .....	42
Beep On ASCII BEL .....	43
Beep On Not on File .....	43
ACK NAK Options .....	44
ACK Character .....	45
NAK Character .....	45
ACK NAK Timeout Value .....	46
ACK NAK Retry Count .....	46
ACK NAK Error Handling .....	47
Indicate Transmission Failure .....	47
Disable Character .....	48
Enable Character .....	48
<b>KEYBOARD INTERFACE .....</b>	<b>49</b>
COUNTRY MODE .....	50
<b>Setup on PC to use ALT Universal .....</b>	<b>50</b>
Setting Country Mode .....	51
<b>OTHER KEYBOARD PARAMETERS .....</b>	<b>65</b>
Encoding Type .....	65
ALT Output Type .....	72
Caps Lock State .....	73
Numlock .....	73
Keyboard Numeric Keypad .....	74
Keyboard Send Control Characters .....	74
Wedge Quiet Interval .....	75
Intercharacter Delay .....	76
Intercode Delay .....	76
USB Keyboard Speed .....	77
<b>USB-OEM INTERFACE .....</b>	<b>78</b>
USB-OEM Device Usage .....	79
USB-OEM Interface Options .....	79

<b>IBM 46XX INTERFACE .....</b>	<b>80</b>
IBM 46xx Interface Options .....	81
<b>DATA FORMAT .....</b>	<b>82</b>
GLOBAL SETTINGS .....	83
Global Prefix/Suffix .....	83
Case Conversion .....	84
Character Conversion .....	84
Global AIM ID .....	85
GS1-128 AIM ID .....	85
LABEL ID .....	86
Label ID: Pre-loaded Sets .....	86
Label ID: Set Individually Per Symbology .....	87
Label ID Control .....	87
Label ID Symbology Selection .....	88
<b>READING PARAMETERS .....</b>	<b>93</b>
SCANNING FEATURES .....	94
Scan Mode .....	94
Scanning Active Time .....	95
Flash On Time .....	95
Flash Off Time .....	96
Double Read Timeout .....	96
Stand /Base Detection Behavior .....	98
Stand Mode/Object Detection Indication (Stand Mode Flash) .....	99
Stand Mode/Object Detection Sensitivity .....	99
Stand Mode/Object Detection Illumination Off Time .....	100
Illumination Intensity .....	100
Illuminator Refresh Frequency .....	101
Corded Stand Mode .....	101
Dock Detection Beep .....	102
Corded Stand Beep .....	102
LED AND BEEPER INDICATORS .....	103
Power On Alert .....	103
Good Read Beep Type .....	103
Good Read Beep Frequency .....	104
Good Read Beep Length .....	105
Good Read Beeper Volume / Vibration .....	106
Vibration Feedback for Good Read .....	106
Silent Mode .....	107
RGB Good Read Enable .....	107
RGB Good Read Color .....	108
Good Read LED Duration .....	109
Good Read: When to Indicate .....	110
Green Spot Duration .....	111
CAMERA CONTROL .....	112
Aiming Pointer .....	112
Aiming Duration Timer .....	112
Pick Mode .....	113
Mobile Phone Mode .....	113
Mobile Phone Saturation Rate .....	114
Decode Negative Image .....	115
Image Capture .....	115
MULTIPLE LABEL READING .....	116
Multiple Labels per Frame .....	116
Multiple Labels Ordering by Code Symbology .....	116
Multiple Labels Ordering by Code Length .....	117
<b>1D SYMBOLOGIES .....</b>	<b>118</b>
DISABLE ALL SYMBOLOGIES .....	119
COUPON CONTROL .....	119
Coupon Control .....	119
UPC-A .....	120
UPC-A Enable/Disable .....	120

UPC-A Check Character Transmission .....	120
Expand UPC-A to EAN-13 .....	121
UPC-A Number System Character Transmission .....	121
UPC-E .....	122
UPC-E Enable/Disable .....	122
UPC-E Check Character Transmission .....	122
Expand UPC-E to EAN-13 .....	123
Expand UPC-E to UPC-A .....	123
UPC-E Number System Character Transmission .....	123
GTIN Formatting .....	124
EAN-13 .....	125
EAN-13 Enable/Disable .....	125
EAN-13 Check Character Transmission .....	125
EAN-13 Flag 1 Character .....	126
EAN-13 to ISBN Conversion .....	126
EAN-13 to ISSN Conversion .....	127
EAN-8 .....	128
EAN-8 Enable/Disable .....	128
EAN-8 Check Character Transmission .....	128
Expand EAN-8 to EAN-13 .....	129
UPC/EAN GLOBAL SETTINGS .....	130
UPC/EAN Price Weight Check .....	130
UPC/EAN Quiet Zones .....	131
Add-Ons .....	131
Optional Add-ons .....	132
Optional Add-On Timer .....	133
GS1 DATABAR™ OMNIDIRECTIONAL .....	134
GS1 DataBar Omnidirectional Enable/Disable .....	134
GS1 DataBar Omnidirectional to GS1-128 Emulation .....	134
GS1 DATABAR™ EXPANDED .....	135
GS1 DataBar Expanded Enable/Disable .....	135
GS1 DataBar Expanded to GS1-128 Emulation .....	135
GS1 DataBar Expanded Length Control .....	136
GS1 DataBar Expanded Set Length 1 .....	136
GS1 DataBar Expanded Set Length 2 .....	137
GS1 DATABAR™ LIMITED .....	138
GS1 DataBar Limited Enable/Disable .....	138
GS1 DataBar Limited to GS1-128 Emulation .....	138
CODE 39 .....	139
Code 39 Enable/Disable .....	139
Code 39 Check Character Calculation .....	139
Code 39 Check Character Transmission .....	140
Code 39 Start/Stop Character Transmission .....	140
Code 39 Full ASCII .....	141
Code 39 Quiet Zones .....	141
Code 39 Length Control .....	142
Code 39 Set Length 1 .....	142
Code 39 Set Length 2 .....	143
TRIOPTIC CODE .....	144
Trioptic Code Enable/Disable .....	144
CODE 39 DANISH PPT .....	144
Code 39 Danish PPT Enable/Disable .....	144
CODE 39 PZN .....	145
Code 39 PZN Enable/Disable .....	145
CODE 39 LA POSTE .....	145
Code 39 La Poste Enable/Disable .....	145
CODE 32 (ITALIAN PHARMACEUTICAL) .....	146
Code 32 Enable/Disable .....	146
Code 32 Feature Setting Exceptions .....	146
Code 32 Check Character Transmission .....	146
Code 32 Start/Stop Character Transmission .....	147

CODE 39 CIP HR (FRENCH PHARMACEUTICAL)	148
Code 39 CIP HR Enable/Disable	148
CODE 128	149
Code 128 Enable/Disable	149
Expand Code 128 to Code 39	149
Code 128 Check Character Transmission	150
Code 128 Function Character Transmission	150
Code 128 Quiet Zones	151
Code 128 Length Control	151
Code 128 Set Length 1	152
Code 128 Set Length 2	152
GS1-128	153
GS1-128 Enable	153
INTERLEAVED 2 OF 5 (I 2 OF 5)	154
I 2 of 5 Enable/Disable	154
I 2 of 5 Check Character Calculation	155
I 2 of 5 Check Character Transmission	156
I 2 of 5 Length Control	157
I 2 of 5 Set Length 1	157
I 2 of 5 Set Length 2	158
INTERLEAVED 2 OF 5, FEBRABAN (DESK MODELS ONLY)	159
Interleaved 2 of 5, Febraban format Enable / Disable	159
INTERLEAVED 2 OF 5 CIP HR	160
Interleaved 2 of 5 CIP HR Enable/Disable	160
MATRIX 2 OF 5	161
Matrix 2 of 5 Enable/Disable	161
Matrix 2 of 5 Check Character Calculation	161
Matrix 2 of 5 Check Character Transmission	162
Matrix 2 of 5 Length Control	162
Matrix 2 of 5 Set Length 1	163
Matrix 2 of 5 Set Length 2	163
STANDARD 2 OF 5	164
Standard 2 of 5 Enable/Disable	164
Standard 2 of 5 Check Character Calculation	164
Standard 2 of 5 Check Character Transmission	165
Standard 2 of 5 Length Control	165
Standard 2 of 5 Set Length 1	166
Standard 2 of 5 Set Length 2	166
COMPRESSED 2 OF 5	167
Compressed 2 of 5 Enable/Disable	167
Compressed 2 of 5 Check Character Calculation	167
Compressed 2 of 5 Check Character Transmission	168
Compressed 2 of 5 Length Control	168
Compressed 2 of 5 Set Length 1	169
Compressed 2 of 5 Set Length 2	169
DATALOGIC 2 OF 5	170
Datalogic 2 of 5 Enable/Disable	170
Datalogic 2 of 5 Check Character Calculation	170
Datalogic 2 of 5 Check Character Transmission	171
Datalogic 2 of 5 Length Control	171
Datalogic 2 of 5 Set Length 1	172
Datalogic 2 of 5 Set Length 2	172
INDUSTRIAL 2 OF 5	173
Industrial 2 of 5 Enable/Disable	173
Industrial 2 of 5 Check Character Calculation	173
Industrial 2 of 5 Check Character Transmission	174
Industrial 2 of 5 Length Control	174
Industrial 2 of 5 Set Length 1	175
Industrial 2 of 5 Set Length 2	175
IATA	176

IATA Enable/Disable .....	176
IATA Check Character Transmission .....	176
FOLLETT 2 OF 5 .....	177
Follett 2 of 5 Enable/Disable .....	177
CODABAR .....	178
Codabar Enable/Disable .....	178
Codabar Check Character Calculation .....	178
Codabar Check Character Transmission .....	179
Codabar Start/Stop Character Transmission .....	179
Codabar Start/Stop Character Set .....	180
Codabar Start/Stop Character Match .....	180
Codabar Quiet Zones .....	181
Codabar Length Control .....	182
Codabar Set Length 1 .....	182
Codabar Set Length 2 .....	183
ABC CODABAR .....	184
ABC Codabar Enable/Disable .....	184
ABC Codabar Concatenation Mode .....	184
ABC Codabar Dynamic Concatenation Timeout .....	185
ABC Codabar Force Concatenation .....	185
ISBT 128 .....	186
ISBT 128 Concatenation .....	186
ISBT 128 Concatenation Mode .....	186
ISBT 128 Dynamic Concatenation Timeout .....	187
ISBT 128 Force Concatenation .....	188
ISBT 128 Advanced Concatenation Options .....	188
CODE 11 .....	189
Code 11 Enable/Disable .....	189
Code 11 Check Character Calculation .....	189
Code 11 Check Character Transmission .....	190
Code 11 Length Control .....	190
Code 11 Set Length 1 .....	191
Code 11 Set Length 2 .....	191
CODE 93 .....	192
Code 93 Enable/Disable .....	192
Code 93 Check Character Calculation .....	192
Code 93 Check Character Transmission .....	193
Code 93 Length Control .....	193
Code 93 Set Length 1 .....	194
Code 93 Set Length 2 .....	194
Code 93 Quiet Zones .....	195
MSI .....	196
MSI Enable/Disable .....	196
MSI Check Character Calculation .....	196
MSI Check Character Transmission .....	197
MSI Length Control .....	197
MSI Set Length 1 .....	198
MSI Set Length 2 .....	198
PHARMACODE .....	199
Pharmacode Enable/Disable .....	199
Pharmacode Label Direction .....	199
Pharmacode Length Control .....	200
Pharmacode Set Length 1 .....	200
Pharmacode Set Length 2 .....	201
PLESSEY .....	202
Plessey Enable/Disable .....	202
Plessey Check Character Calculation .....	202
Plessey Check Character Transmission .....	203
Plessey Length Control .....	203
Plessey Set Length 1 .....	204
Plessey Set Length 2 .....	204



BC412 .....	205
BC412 Enable/Disable .....	205
BC412 Check Character Calculation .....	205
BC412 Length Control .....	206
BC412 Set Length 1 .....	207
BC412 Set Length 2 .....	207
<b>2D SYMBOLOGIES .....</b>	<b>208</b>
2D GLOBAL FEATURES .....	209
2D Maximum Decoding Time .....	210
2D Structured Append .....	211
2D Normal/Inverse Symbol Control .....	211
AZTEC CODE .....	212
Aztec Code Enable / Disable .....	212
Aztec Code Length Control .....	212
Aztec Code Set Length 1 .....	213
Aztec Code Set Length 2 .....	213
CHINA SENSIBLE CODE .....	214
China Sensible Code Enable / Disable .....	214
China Sensible Code Length Control .....	214
China Sensible Code Set Length 1 .....	215
China Sensible Code Set Length 2 .....	215
DATA MATRIX .....	216
Data Matrix Enable / Disable .....	216
Data Matrix Square/Rectangular Style .....	216
Data Matrix Length Control .....	217
Data Matrix Set Length 1 .....	217
Data Matrix Set Length 2 .....	218
GS1 DOTCODE .....	219
DotCode Enable .....	219
DotCode High Resolution Enable .....	219
DotCode Position-based Decoding .....	220
Additional Options .....	220
MAXICODE .....	221
Maxicode Enable / Disable .....	221
Maxicode Primary Message Transmission .....	221
Maxicode Length Control .....	222
Maxicode Set Length 1 .....	222
Maxicode Set Length 2 .....	223
PDF417 .....	224
PDF417 Enable / Disable .....	224
PDF417 Length Control .....	224
PDF417 Set Length 1 .....	225
PDF417 Set Length 2 .....	225
MICRO PDF417 .....	226
Micro PDF417 Enable / Disable .....	226
Micro PDF417 Code 128 GS1-128 Emulation .....	226
Micro PDF417 Length Control .....	227
Micro PDF417 Set Length 1 .....	227
Micro PDF417 Set Length 2 .....	228
QR CODE .....	229
QR Code Enable / Disable .....	229
QR Code Length Control .....	229
QR Code Set Length 1 .....	230
QR Code Set Length 2 .....	230
MICRO QR CODE .....	231
Micro QR Code Enable / Disable .....	231
Micro QR Code Length Control .....	231
Micro QR Code Set Length 1 .....	232
Micro QR Code Set Length 2 .....	232
UCC COMPOSITE .....	233
UCC Optional Composite Timer .....	233

Postal Code Selection .....	234
Postnet BB Control .....	235
<b>OCR DECODING .....</b>	<b>236</b>
OCR Decoding Predefined Templates .....	237
<b>MOTION FEATURES .....</b>	<b>238</b>
Motionless Timeout .....	239
Motion Sensitivity .....	239
High Motion Immunity .....	240
Motion Aiming Control .....	240
<b>POWER MANAGEMENT .....</b>	<b>241</b>
POWER SAVE .....	242
Powerdown Timeout .....	242
BATTERY PROFILES .....	243
Battery Profiles .....	243
Battery Information .....	244
<b>WIRELESS FEATURES .....</b>	<b>245</b>
WIRELESS BEEPER FEATURES .....	246
Good Transmission Beep .....	246
Beeper Frequency .....	246
Beep Duration .....	247
Beep Volume .....	248
Disconnect Beep .....	248
Docking (Connecting) Beep .....	249
Leash Alarm .....	249
CONFIGURATION UPDATES .....	251
Automatic Configuration Update .....	251
Copy Configuration to Reader .....	251
Copy Configuration to Base Station .....	251
BATCH FEATURES .....	252
Batch Mode .....	252
Send Batch .....	252
Erase Batch Memory .....	253
RF Batch Mode Transmit Delay .....	253
DIRECT RADIO AUTOLINK .....	254
Direct Radio Autolink .....	254
RF ADDRESS STAMPING .....	255
Source Radio Address Transmission .....	255
Source Radio Address Delimiter Character .....	255
BLUETOOTH-ONLY FEATURES .....	256
Bluetooth Security Level .....	256
Bluetooth Radio Output Power .....	257
Wi-Fi Channels Exclusion .....	258
BLUETOOTH HID FEATURES .....	263
Bluetooth HID Alt Mode .....	263
FEATURES FOR STAR MODELS ONLY .....	264
STAR Radio Protocol Timeout .....	264
STAR Radio Transmit Mode .....	265
STAR System Speed .....	266
STAR Frequency Agility .....	267
<b>CHAPTER 4. REFERENCES .....</b>	<b>269</b>
<b>RS-232 Parameters .....</b>	<b>270</b>
<b>RS-232 Only .....</b>	<b>270</b>
Baud Rate .....	270
Data Bits .....	270
Stop Bits .....	270
Parity .....	270
Handshaking Control .....	270
<b>RS-232/USB COM Parameters .....</b>	<b>271</b>
Intercharacter Delay .....	271
ACK NAK Options .....	272

ACK Character .....	272
NAK Character .....	273
ACK NAK Timeout Value .....	274
ACK NAK Retry Count .....	275
Disable Character .....	276
Enable Character .....	277
<b>Keyboard Interface .....</b>	<b>278</b>
Wedge Quiet Interval .....	278
Intercharacter Delay .....	279
Intercode Delay .....	280
<b>Data Format .....</b>	<b>281</b>
Data Editing .....	281
Please Keep In Mind... .....	281
Global Prefix/Suffix .....	282
Example: Setting a Prefix .....	282
Global AIM ID .....	283
Label ID .....	284
Label ID: Pre-loaded Sets .....	284
Label ID: Set Individually Per Symbology .....	286
Character Conversion .....	288
<b>Scanning Features .....</b>	<b>289</b>
Scan Mode .....	289
Scanning Active Time .....	290
Aiming Duration Time .....	291
Flash On Time .....	292
Flash Off Time .....	293
<b>LED and Beeper Indicators .....</b>	<b>294</b>
Good Read LED Duration .....	294
<b>RF Features .....</b>	<b>295</b>
Automatic Configuration Update .....	295
RF Address Stamping .....	295
Source Radio Address Delimiter Character .....	295
STAR Radio Protocol Timeout .....	296
<b>Symbologies .....</b>	<b>297</b>
Set Length .....	297
Set Length 1 .....	297
Set Length 2 .....	298
<b>CHAPTER 5. MESSAGE FORMATTING .....</b>	<b>299</b>
<b>Message Formatting .....</b>	<b>299</b>
<b>LED and Beeper Control .....</b>	<b>300</b>
<b>APPENDIX A. TECHNICAL SPECIFICATIONS .....</b>	<b>301</b>
<b>GD4500 Technical Specifications .....</b>	<b>301</b>
<b>GBT/GM4500 Technical Specifications .....</b>	<b>303</b>
<b>Common Reading Characteristics .....</b>	<b>305</b>
<b>Decoding Capabilities .....</b>	<b>306</b>
<b>LED and Beeper Indications .....</b>	<b>307</b>
<b>User Indications for GD4500 .....</b>	<b>307</b>
<b>User Indications for GBT/GM4500 (Gun Only) .....</b>	<b>308</b>
<b>User Indications for WLC4090 Base Stations .....</b>	<b>310</b>
<b>Programming Mode .....</b>	<b>311</b>
<b>Troubleshooting .....</b>	<b>311</b>
<b>APPENDIX B. STANDARD DEFAULTS.....</b>	<b>313</b>
<b>Default exceptions .....</b>	<b>327</b>
<b>APPENDIX C. SAMPLE BARCODES.....</b>	<b>329</b>
<b>Sample Barcodes .....</b>	<b>329</b>
1D Barcodes .....	329

GS1 Databar™ (RSS) .....	331
GS1 Databar™ (-14) .....	331
2D Barcodes .....	332
<b>APPENDIX D. KEYPAD .....</b>	<b>334</b>
<b>APPENDIX E. SCANCODE TABLES .....</b>	<b>336</b>
<b>Control Character Emulation .....</b>	<b>336</b>
Single Press and Release Keys .....	336
<b>Interface Type PC AT PS/2, USB-Keyboard or USB-Keyboard for APPLE .....</b>	<b>337</b>
<b>Interface Type PC AT PS/2, USB-Keyboard or USB-Keyboard for APPLE (continued) .....</b>	<b>338</b>
<b>Interface Type PC AT PS/2 Alt Mode or USB-Keyboard Alt Mode .....</b>	<b>339</b>
<b>Interface Type PC AT PS/2 Alt Mode or USB-Keyboard Alt Mode (continued) .....</b>	<b>340</b>
<b>Digital Interface .....</b>	<b>341</b>
<b>IBM31xx 102-key .....</b>	<b>342</b>
<b>IBM XT .....</b>	<b>344</b>
<b>Microsoft Windows Codepage 1252 .....</b>	<b>346</b>
<b>APPENDIX F. ASCII CHART.....</b>	<b>347</b>

# PREFACE

---

## ABOUT THIS MANUAL

This Product Reference Guide (PRG) is provided for users seeking advanced technical information, including connection, programming, maintenance and specifications. The Quick Reference Guide (QRG) and other publications associated with this product are downloadable free of charge from the website listed on the back cover of this manual.

Typically, units are factory-programmed for the most common terminal and communications settings. If you need to modify any programmable settings, custom configuration can be accomplished by scanning the programming bar codes within this guide.

Programming can alternatively be performed using the Datalogic Aladdin™ Configuration application, which is available from the Datalogic website listed on the back cover of this manual. This multi-platform utility program allows device configuration using a PC. It communicates to the device using a serial or USB cable and can also create configuration bar codes to print.

## OVERVIEW

**Chapter 1**, Introduction provides a product overview, battery safety information, and general information about programming the reader.

**Chapter 2**, Setup presents information about unpacking and setting up the reader, and interface configuration bar codes and details.

**Chapter 3**, Configuration Using Bar Codes provides instructions and bar code labels for customizing your reader. There are different sections for interface types, general features, data formatting, and symbology-specific features.

**Chapter 4**, References provides details concerning programmable features.

**Appendix A**, Technical Specifications lists physical and performance characteristics, as well as environmental specifications. It also provides standard cable pin-outs and descriptions of the functions and behaviors of the reader's LED and Beeper indicators.

**Appendix B**, references common factory default settings for reader features and options.

**Appendix C**, Sample Bar Codes offers sample bar codes of several common symbologies.

**Appendix D**, Keypad includes numeric bar codes to be scanned for certain parameter settings.

**Appendix E**, Scancode Tables lists control character emulation information for Wedge and USB Keyboard interfaces.

**Appendix F**, ASCII Chart lists hexadecimal reference values for ASCII characters.

## Manual Conventions

The following conventions are used in this document:

The symbols listed below are used in this manual to notify the reader of key issues or procedures that must be observed when using the reader:



**NOTE:** This symbol draws attention to details or procedures that may be useful in improving, maintaining, or enhancing the performance of the hardware or software being discussed.



**CAUTION:** This symbol advises you of actions that could damage equipment or property.



**WARNING:** This symbol advises you of actions that could result in harm or injury to the person performing the task.



**HIGH VOLTAGE:** This symbol alerts the user they are about to perform an action involving, either a dangerous level of voltage, or to warn against an action that could result in damage to devices or electrical shock.



**LASER:** This symbol alerts the user they are about to perform an action involving possible exposure to laser light radiation.



**GROUNDING:** This symbol advises you to pay particular attention to the grounding instructions for correct device functioning.



**ESD:** This symbol identifies a procedure that requires you take measures to prevent Electrostatic Discharge (ESD) e.g., use an ESD wrist strap. Circuit boards are most at risk. Please follow ESD procedures.

## TECHNICAL SUPPORT

### Support Through the Website

Datalogic provides several services as well as technical support through its website. Log on to ([www.datalogic.com](http://www.datalogic.com)).

For quick access, from the home page click on the search icon , and type in the name of the product you're looking for. This allows you access to download Data Sheets, Manuals, Software & Utilities, and Drawings.

Hover over the Support & Service menu for access to Services and Technical Support.

### Reseller Technical Support

An excellent source for technical assistance and information is an authorized Datalogic reseller. A reseller is acquainted with specific types of businesses, application software, and computer systems and can provide individualized assistance.

# CHAPTER 1

## INTRODUCTION

---

### ABOUT THE READER

With rich feature sets and extensive model options, the Gryphon™ product series from Datalogic represents the premium level of data collection equipment for general purpose applications. The Gryphon I GD4500 reader has enhanced Megapixel optics with improved motion tolerance, allowing codes placed on fast-moving objects to be easily and quickly captured, creating the ideal reader for tasks requiring high throughput like those found in retail, light industrial environments and healthcare.

### USING THE GRYPHON™ I GD4500 READER

To read a symbol or capture an image, simply aim the reader and pull the trigger. The Gryphon™ I GD4500 is a powerful omni-directional reader, so the orientation of the symbol is not important. Datalogic's exclusive patented 'Green Spot' for good-read feedback helps to improve productivity in noisy environments or in situations where silence is required. When positioning the product into the stand, the magnetic coupling will make the reader automatically detect a bar code inside the field of view, and switch the reading system from trigger mode to autosense mode.

The Gryphon™ I GD4500 reliably decodes all standard 1D (linear) and 2D bar codes, including GS1 DataBar™ linear codes, Postal Codes (China Post), Stacked Codes (such as GS1 DataBar Expanded Stacked, GS1 DataBar Stacked, GS1 DataBar, Stacked Omnidirectional). The data stream - acquired from decoding a symbol - is rapidly sent to the host. The reader is immediately available to read another symbol.

**Figure 1 - Correct positioning of the reader**



## BATTERY SAFETY

To reinstall, charge and/or perform any other action on the battery, follow the instructions in this manual.



**NOTE:** Before installing the Battery, read “Battery Safety” on this and the following pages. Datalogic recommends annual replacement of rechargeable battery packs to ensure maximum performance.



**WARNING:** Do not discharge the battery using any device except for the reader. When the battery is used in devices other than the designated product, it may damage the battery or reduce its life expectancy. If the device causes an abnormal current to flow, it may cause the battery to become hot, explode or ignite and cause serious injury.

Lithium-ion battery packs may get hot, explode or ignite and cause serious injury if exposed to abusive conditions. Be sure to follow the safety warnings listed below:

- Do not place the battery pack in fire or heat.
- Do not connect the positive terminal and negative terminal of the battery pack to each other with any metal object (such as wire).
- Do not carry or store the battery pack together with metal objects.
- Do not pierce the battery pack with nails, strike it with a hammer, step on it or otherwise subject it to strong impacts or shocks.
- Do not solder directly onto the battery pack.
- Do not expose the battery pack to liquids, or allow the battery to get wet.
- Do not apply voltages to the battery pack contacts.

In the event the battery pack leaks and the fluid gets into your eye, do not rub the eye. Rinse well with water and immediately seek medical care. If left untreated, the battery fluid could cause damage to the eye.





**CAUTION:** Always charge the battery at 32° – 104°F (0° - 40°C) temperature range.

**Use only the authorized power supplies, battery pack, chargers, and docks supplied by your Datalogic reseller. The use of any other power supplies can damage the device and void your warranty.**

**Do not disassemble or modify the battery. The battery contains safety and protection devices, which, if damaged, may cause the battery to generate heat, explode or ignite.**

**Do not place the battery in or near fire, on stoves or other high temperature locations.**

**Do not place the battery in direct sunlight, or use or store the battery inside cars in hot weather. Doing so may cause the battery to generate heat, explode or ignite. Using the battery in this manner may also result in a loss of performance and a shortened life expectancy.**

**Do not place the battery in microwave ovens, high-pressure containers or on induction cookware.**

**Immediately discontinue use of the battery if, while using, charging or storing the battery, the battery emits an unusual smell, feels hot, changes color or shape, or appears abnormal in any other way.**

**Do not replace the battery pack when the device is turned on.**

**Do not remove or damage the battery pack's label.**

**Do not use the battery pack if it is damaged in any part.**

**Battery pack usage by children should be supervised.**



**CAUTION:** Storage of batteries for long time at fully charged status or at fully discharged status should be avoided.



**CAUTION:** Only in case of long storage, to avoid deep discharge of the battery it is recommended to partially recharge the battery every three months to keep the charge status at a medium level.

**As a reference, run a fast recharge for 20 minutes every three months on unused products to avoid any performance deterioration of the cell.**

As with other types of batteries, Lithium-Ion (LI) batteries will lose capacity over time. Capacity deterioration is noticeable after one year of service whether the battery is in use or not. It is difficult to precisely predict the finite life of a LI battery, but cell manufacturers rate them at 500 charge cycles. In other words, the batteries should be expected to take 500 full discharge / charge cycles before needing replacement. This number is higher if partial discharging / recharging is adhered to rather than full / deep discharging,

The typical manufacturer advertised useful life of LI batteries is one to three years, depending on usage and number of charges, etc., after which they should be removed from service, especially in mission critical applications. Do not continue to use a battery that is showing excessive loss of capacity, it should be properly recycled / disposed of and replaced. For most applications, batteries should be replaced after one year of service to maintain customer satisfaction and minimize safety concerns.

Collect and recycle waste batteries separately from the device in compliance with European Directive 2006/66/EC, 2011/65/EU, 2002/96/EC and 2012/19/EU and subsequent modifications, US and China regulatory and others laws and regulations about the environment.

# PROGRAMMING THE READER

## Configuration Methods

### Programming Bar Codes

The reader is factory-configured with a standard set of default features. After scanning the interface bar code, you can select other options and customize your reader through use of the instructions and programming bar code labels available in the corresponding features section for your interface. Customizable settings for many features are found in [Configuration Parameters, starting on page 33](#).

Some programming labels, like “Restore Custom Defaults”, require only the scan of the single label to enact the change. Most, however, require the reader to be placed in Programming Mode prior to scanning them. Scan an ENTER/EXIT bar code once to enter Programming Mode. Once the reader is in Programming Mode, scan a number of parameter settings before scanning the ENTER/EXIT bar code a second time, which will then accept your changes, exit Programming Mode and return the reader to normal operation.



**NOTE: There are some exceptions to the typical programming sequence described above. Please read the description and setting instructions carefully when configuring each programmable feature.**

### Datalogic Aladdin™

Datalogic Aladdin™ is a multi-platform utility program providing a quick and user-friendly configuration method via the RS-232/USB-COM interface. Aladdin allows you to program the reader by selecting configuration commands through a user-friendly graphical interface running on a PC. These commands are sent to the reader over the selected communication interface, or they can be printed as bar codes to be scanned. Aladdin also facilitates image capturing.

In addition, Aladdin makes it easy to upgrade the handheld's firmware, to attain the benefits of new reader features. Reference the Datalogic Aladdin™ Online Help for more details.

Aladdin is available for download free of charge on the Datalogic website.

# CHAPTER 2

## SETUP

---

### UNPACKING

Check carefully to ensure the reader and any cables or accessories ordered are present and undamaged. If any damage occurred during shipment, contact "Technical Support" on page xiv.

### SETTING UP THE GRYPHON™ GD4500 READER

Depending on whether you are using a Corded or Wireless version of the Gryphon, follow the steps provided in this section to connect and get your reader up and communicating with its host:

1. Connect the Interface Cable to the reader as shown in Figure 2. To disconnect the cable, insert a paper clip or similar object into the opening shown.
2. Connect the other end to the Host (see the next section, "Connect Host Interface" on page 6 and Figure 5).
3. Modify "Customizing Configuration Settings" on page 30 (only if modifications are needed from factory settings).



**NOTE: According to Regulation for shipping Li-Ion based battery packs, the products and their spare battery packs parts are shipped with a very low residual charge (low state of charge).**

**Hence the needs:**

**that a new product must be fully recharged before starting to use it and that battery packs of the stocked products GBT/GM45 and spare battery pack parts must be periodically recharged : for instance by using a WLC4090 base station powered up with a 12V Datalogic AC/DC adapter (cod. 8-0935) for at least 30 minutes each 3 months.**

## CONNECT HOST INTERFACE

The reader kit you ordered to match your interface should provide a compatible cable for your installation. If this is not so, contact "Technical Support" on page xiv.

The reader can communicate using the interfaces illustrated below.

For corded versions, connect the reader cable by inserting the cable into the handle as shown in the following Figure.

To remove the interface cable from the reader, first locate the hole on the back of the handle. Next, take a paper clip and modify it as shown in the figure below. Insert the end of the paper clip into the hole and press it to push on the clip that holds the connector. As you apply pressure, pull out the cable.

When reinserting the cable, make sure the connector clip is on the same side as the reader release hole. Insert the cable, it should click when it is fully inserted.



**NOTE: We recommend the use of a perfectly straight new paper clip to make the operation easier (see the figure below).**

**Figure 2. Cable Connection/Disconnection at the Reader**

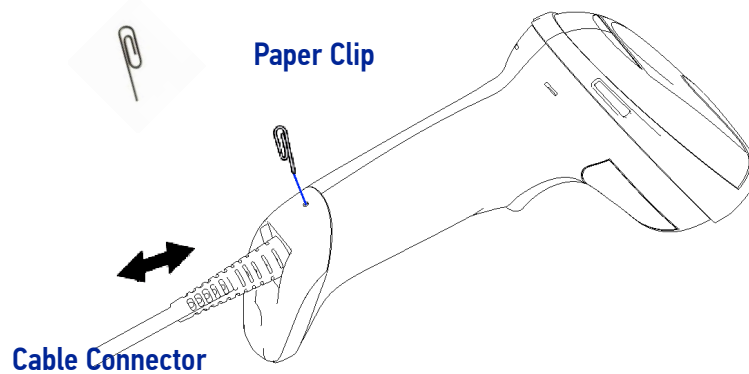

## RS-232 Serial Connection

Turn off power to the terminal/PC and connect the reader to the terminal/PC serial port via the RS-232 cable as shown in Figure 3. If the terminal will not support POT (Power Off the Terminal) to supply reader power, use the approved power supply (AC Adapter). Plug the AC Adapter barrel connector into the socket on the RS-232 cable connector and the AC Adapter plug into a standard power outlet.

**RS-232:** The reader can communicate with a standard or Wincor-Nixdorf (W-N) RS-232 host.

**RS-232 OPOS:** This interface is used for OPOS/UPOS/JavaPOS systems.

**Figure 3 - Connection to the Host**



## Keyboard Wedge Connection

The Keyboard Wedge cable has a 'Y' connection from the reader. Connect the female to the male end from the keyboard and the remaining end at the keyboard port at the terminal/PC.

**Keyboard Wedge (KBW):** When connected using this interface, the host interprets scanned data as keystrokes and supports several international keyboards (for the Windows® environment). See "Setting Country Mode" on page 51 for a full listing.

Figure 4 - Connection to the Host



**NOTE:** The Wedge interface is supported by products manufactured until June 2023.

## USB Connection

Connect the reader to a USB port on the terminal/PC using the correct USB cable for the interface type you ordered.

**USB:** Select to communicate either by USB OEM, USB COM STD, or USB Keyboard interface types by scanning the appropriate interface type bar codes available in this manual. The default interface is USB-KBD, or RS-232-STD.

Figure 5 - Connection to the Host



**NOTE:** Specific cables are required for connection to different hosts. The connections illustrated in Figure 5 are examples only. Actual connectors may vary from those illustrated, but the steps to connect the reader remain the same.

## STAND INSTALLATION

### Hands-Free Stand/Holder

An accessory is available which holds the reader (except those with integrated stand) at a convenient angle, allowing hands free scanning of items.

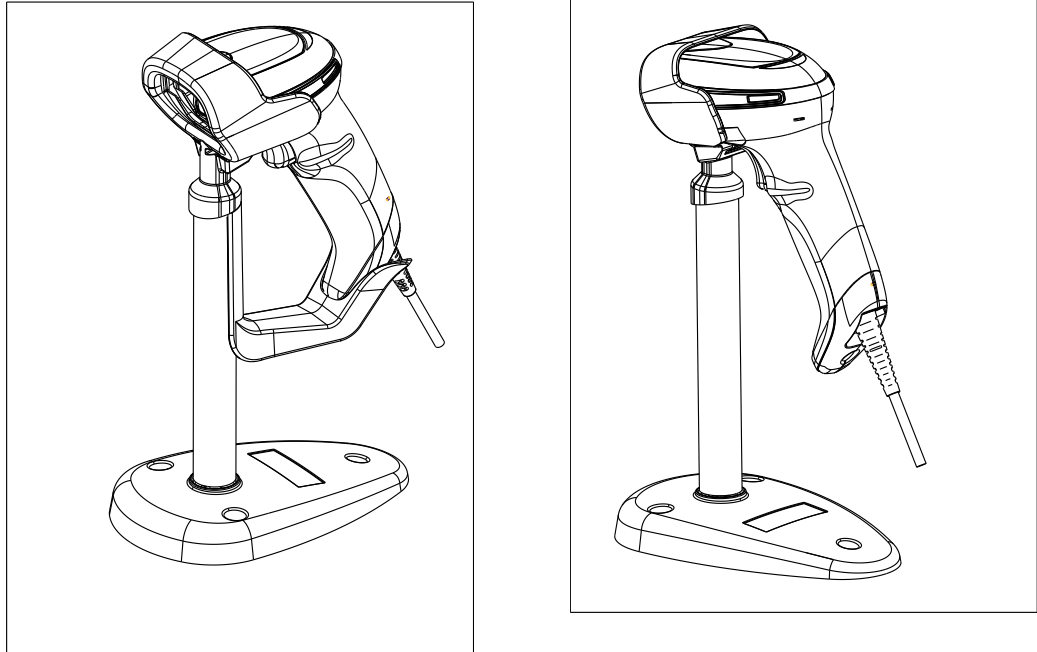

It can also be used as a holder. The holder “cup” can be positioned in any of the angles shown in the figure below. The Desk model automatically recognizes the insertion and changes its Scan Mode to allow the user to operate in hands-free mode.

**Figure 6 - Adjusting the Stand Arm**

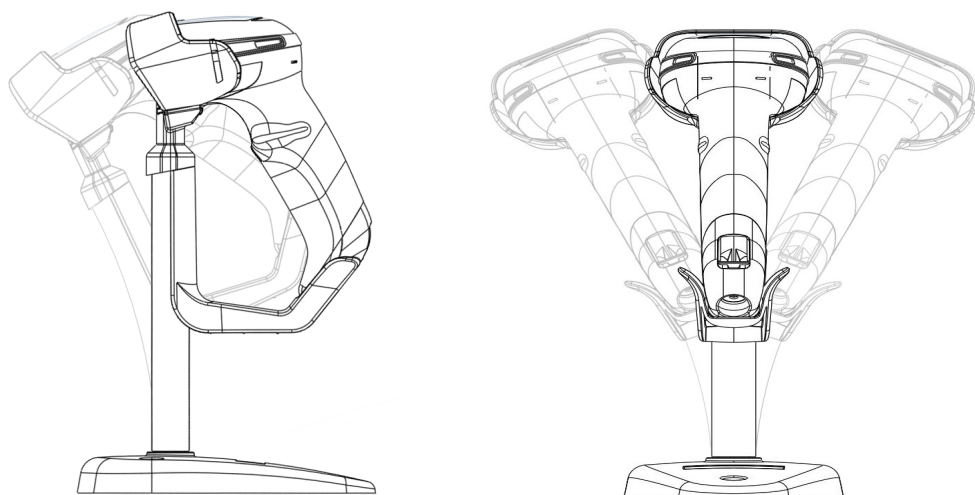

## SETTING UP THE GRYPHON™ GM/GBT4500 READER

Follow the steps below to connect and get your reader up and communicating with its host.

1. Configure the Base Station starting on [page 14](#)
2. Link to the Base Station on [page 24](#)
3. Select the Interface Type on [page 26](#).



**NOTE: According to recent modification of Regulation for shipping Li-Ion based battery packs, the products and their spare battery packs parts are shipped with a very low residual charge (low state of charge).**

**Hence the needs**

**\* that a new product must be fully recharged before starting to use it.**

**and**

**\* that battery packs of the stocked products GBT/GM45 and spare battery pack parts must be periodically recharged: for instance by using a WLC4090 base station powered up with a 12V Datalogic AC/DC adapter (cod.8-0935) for at least 30 minutes each 3 months..**

## POSITIONING THE BASE STATION

The base station may be set up in desk application to hold the reader in three different positions, either a horizontal or standing or vertical position, in order to provide the most comfortable use depending on the needs.

### Base Station Positions and Related Clips to be Used

**Figure 7 - Horizontal Position**



The base station may be set up in desk application to hold the reader in three different positions, either a horizontal or standing or vertical position, in order to provide the most comfortable use depending on the needs.

**Figure 8 - Presentation Position**



This position is preferred if the reader is to be used in stand mode and not needed to be often removed from base station.



**Figure 9 - Vertical Position**

This position is preferred when lack of room on the desktop recommends the reader to be left vertical during recharging.

1. Insert the appropriate parts for the desired base station position.
2. Release the screw situated on the bottom of the base station (the screw will be kept in position by the blue ring).

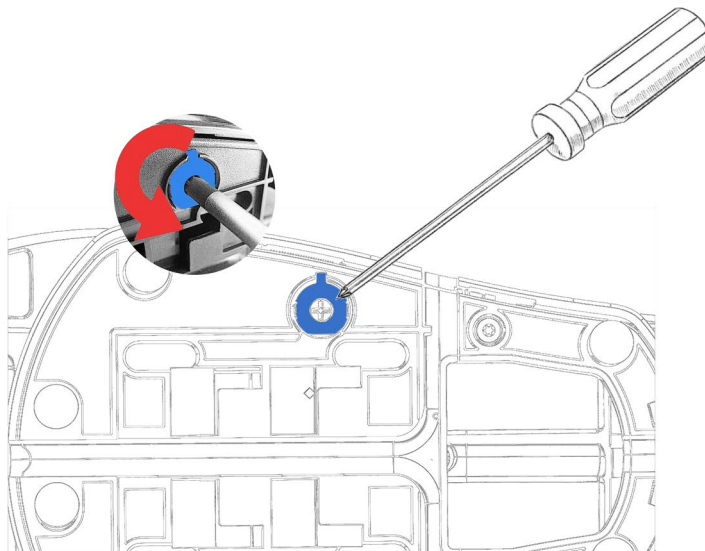

- Using your thumbs, push open the plastic tabs on the bottom of the base to free the wing holders.



- The stand can now be repositioned in either horizontal or standing position.



**NOTE:** To improve the robustness (against accidental falls) of the base station in Presentation Position, it is suggested to add the Shock Absorber addendum as illustrated below.

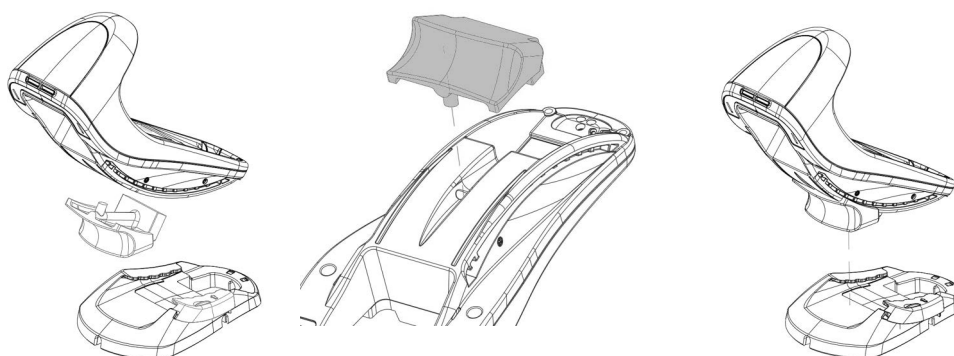

## READER, BASE STATION AND LEDS DESCRIPTION

LEDs on the gun provide information about the battery charging status as well as data transmission.

**Figure 10 - Gryphon 4500 Gun LEDs**

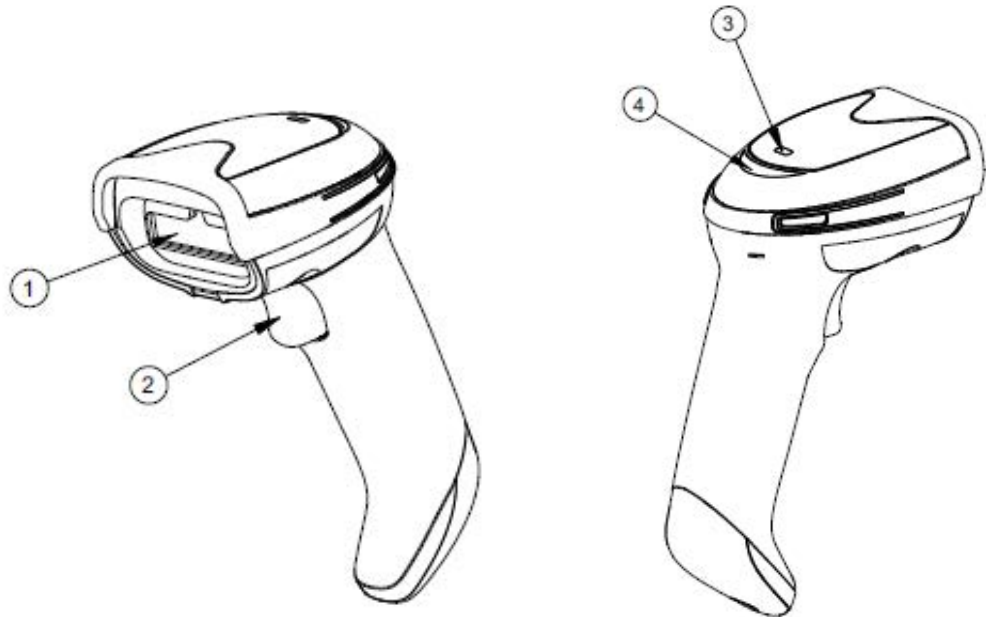

- 1. Scan Window
- 2. Trigger

- 3. Battery & Recharge LED
- 4. Good Read LED

**Figure 11 - WLC4090 Base Station LEDs**

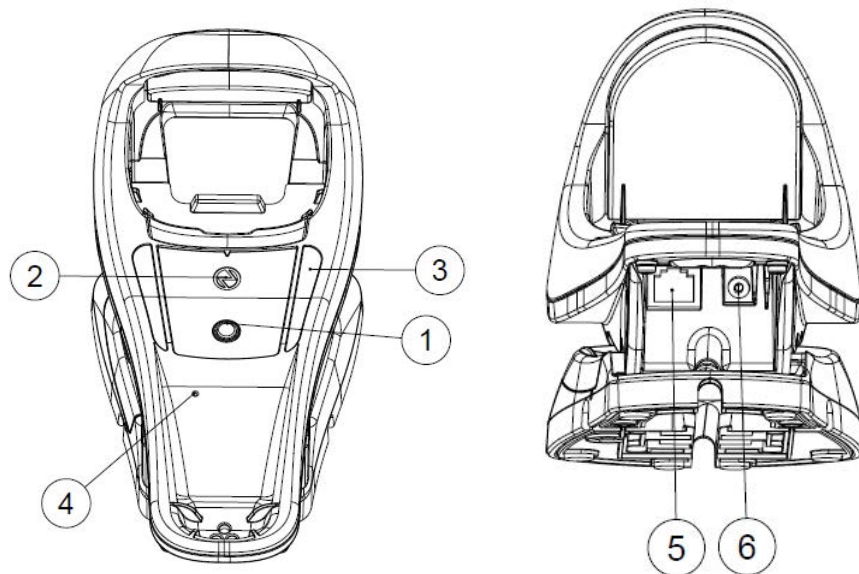

- 1. Service Button
- 2. Power LED
- 3. Recharge LED

- 4. Cable Release Hole
- 5. Communication Port
- 6. Aux Power Port

## CONNECTING THE BASE STATION

The following figure shows how to connect the base station to a terminal, PC or other host device. Turn off the host before connection and consult the manual for that equipment (if necessary) before proceeding. Connect the interface cable before applying power to the Base Station.



**NOTE: The Gryphon GBT/GM4500 can also be Powered by the Terminal. When powered by the Terminal, the battery charger is automatically set to Slow charge.**

**For some specific interfaces or hosts or lengths of cable, the use of an external power supply is recommended for full recharging capability (see GD4500 Technical Specifications, starting on page 301 for more details).**

### Base Station Connection and Routing

Fully insert the Power Cable and Interface (I/F) Cable connectors into their respective ports in the underside of the base station. Then connect to an AC Adapter, and plug the AC power cord into the (wall) outlet.

**Figure 12 - Connecting the Base Station**

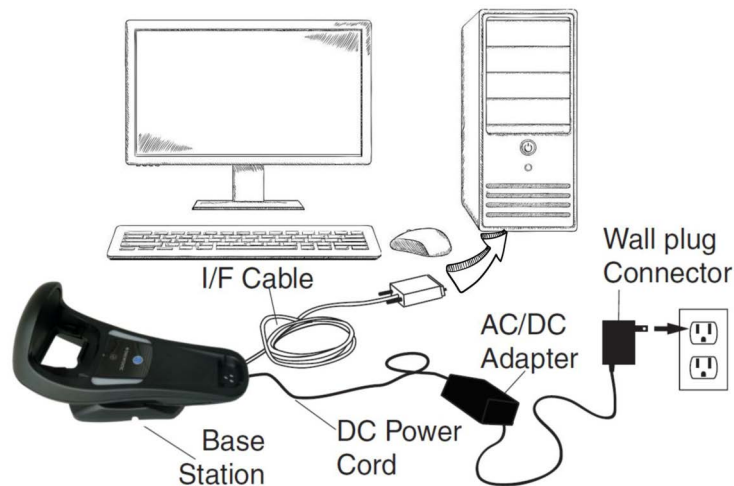

## Securing the DC Power Cord (Optional)

The DC power cord for the adapter can be secured to the bottom of the base in order to maximize the mechanical retention of the cable itself. The routing of the cable can be changed to accommodate base station positioning: horizontal or vertical mount. The cable can be looped around to the front of the base station, or fed directly out the back of the base station, as shown in the figure below.

**Figure 13 - Options for routing the cable**



## Host Connection

Verify before connection that the reader's cable type is compatible with your host equipment. Most connections plug directly into the host device as shown in Figure 15. Keyboard Wedge interface cables have a 'Y' connection where its female end mates with the male end of the cable from the keyboard and the remaining end at the keyboard port on the terminal/PC as shown in Figure 15.

**Figure 14 - Connecting to the Host**



**Figure 15 - Connecting to the Host with Keyboard Wedge Interface**



## Power Connection

Plug the AC Adapter into an approved AC wall socket with the cable facing downwards to prevent undue strain on the socket.

## Disconnecting the Cable

To detach the cable, insert a paper clip or similar object into the hole on the base, as shown.

**Figure 16 - Disconnecting the cable**



# SYSTEM AND NETWORK LAYOUTS

## Stand Alone Layouts

Figure 17 - Single Reader Layout

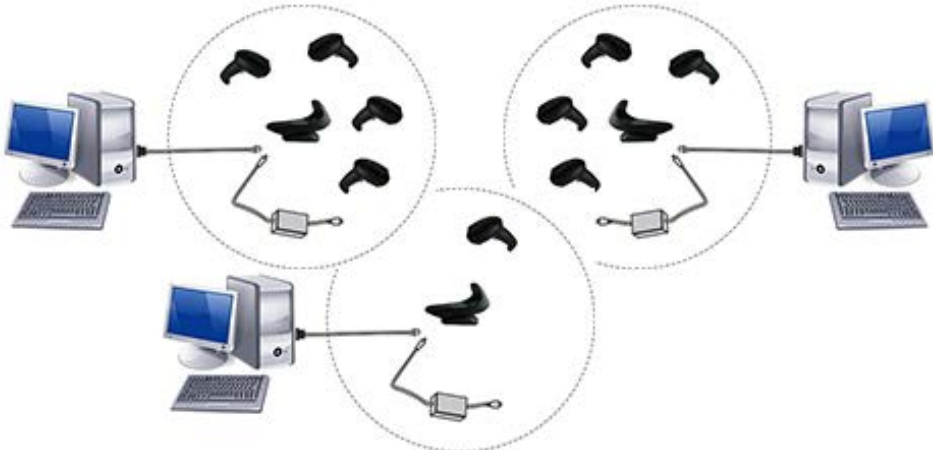

Figure 18 - Multiple Reader Layout



In stand alone systems, each base station is connected to a single Host.

Figure 19 - Multiple Stand Alone Layouts



Many stand alone connections can operate in the same physical area without interference, provided all readers and base stations in the system have different addresses.

## USING THE GBT/GM4500 READER

### Reader LEDs

Specific LEDs on the Gryphon reader provide information about: good reading result (3GL), battery status. The Battery Status information can be easily retrieved by double-tapping with your fingers on top of the head of the reader. The following table explains the main color combinations provided by the Battery Status LED.

**Table 1 - Battery LED**

LED	STATUS
<b>Charge in Progress through micro USB</b>	
<b>Green blinking</b> (1s ON - 1s OFF)	50% - 99%
<b>Amber blinking</b> (1s ON - 1s OFF)	1% - 49%
<b>Red blinking</b> (1s ON - 1s OFF)	Charge less than 1% <b>NOTE:</b> Reader is unusable until 1% is reached
<b>Solid Green</b>	Charge 100% <b>NOTE:</b> It goes OFF when the reader is unplugged
<b>Battery Status (when not in charge)</b>	
<b>Green (3s time-out)</b>	50% - 100%
<b>Amber (3s time-out)</b>	2% - 50%
<b>Red (3s time-out)</b>	Charge less than 2%



# USING THE WLC4090 RADIO BASE

## Radio Base LEDs

LEDs on the Gryphon Base provide information about the Base as well as battery charging status, as shown in the figure below.

Figure 20 - Gryphon Base LEDs



Table 2 - Radio Base LEDs

LED	STATUS
1 Power on / Data	Green On = Base is powered Green Blinking = Base receives data and commands from the Host or the Reader.
2 Charging	Green ON = the battery is completely charged Green fading = battery level 50 to 99% Amber fading = battery level 0 to 49%

The capacitive touch button can be used to force device connection via the Datalogic Aladdin Software tool and for paging the reader when it is activated. See also [User Indications for WLC4090 Base Stations, starting on page 310](#).

## REPLACING THE BATTERY PACK



**NOTE:** Before proceeding, read “Battery Safety” on page 2. To ensure maximum performance, Datalogic recommends the replacement of the rechargeable battery pack if you note either of the following conditions:

- battery life drops below approximately 80% of the original life;
- battery charging time increases significantly.

Use the following procedure to change the reader’s battery:

1. With a narrow metallic object (i.e. a coin) or a screwdriver, unscrew the battery cover screw.



2. Extract the battery pack from its slot.



3. Insert the new battery in the same position.



4. Replace the battery holder cap, plug in the connector and return the contacts circuit to its previous location.



**NOTE: When inserting the new battery into the handle, take care to position the battery and the connector as illustrated above.**

5. Insert the cover in the handle and screw it into place.



## USING THE GRYPHON™ I GD/GBT/GM4500

The Gryphon™ I 4500 Family normally functions by capturing and decoding codes. The aiming system is activated on trigger pull and indicates the center of the field of view which should be positioned over the bar code:

### Aiming System

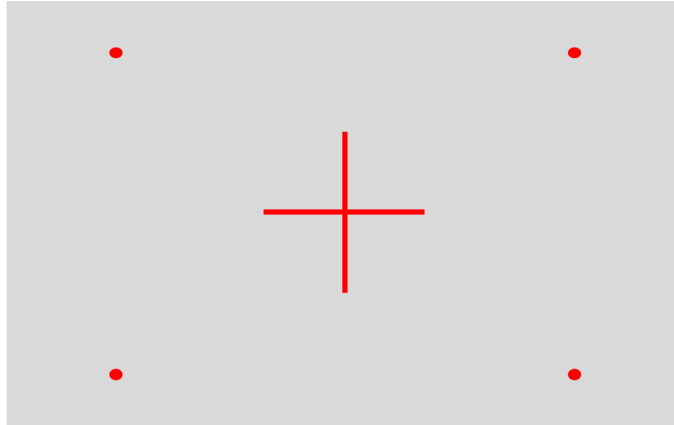

### Relative Size and Location of Aiming System Pattern

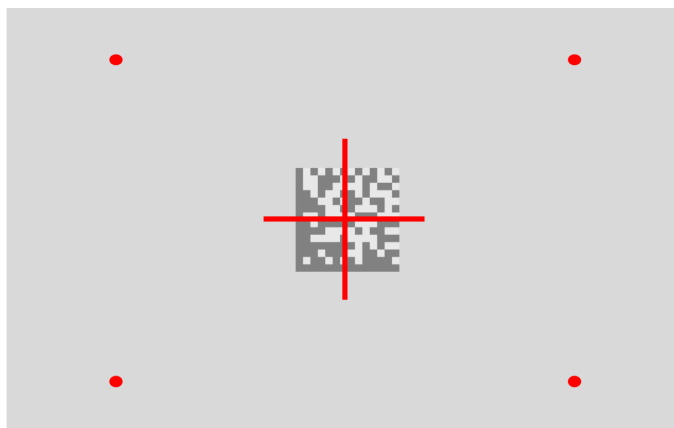

### 2D Matrix Symbol

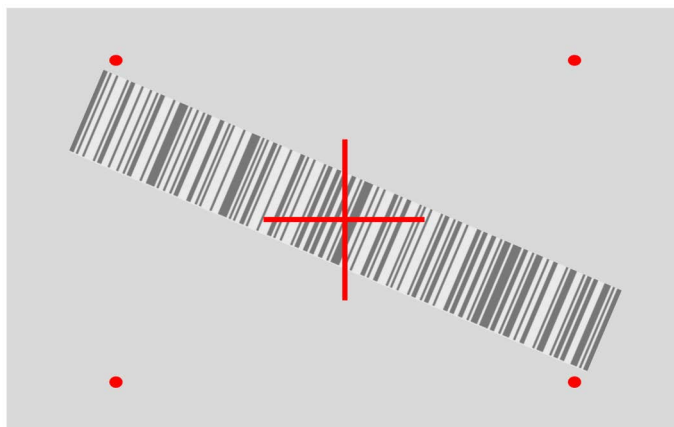

### Linear Bar

A red beam illuminates the label. The field of view indicated by the aiming system will be smaller when the reader is closer to the bar code and larger when it is farther from the code. Symbologies with smaller bars or elements (mil size) should be read closer to the unit. Symbologies with larger bars or elements (mil size) should be read farther from the unit. If the aiming system is centered and the entire bar code is within the aiming field, you will get a good read. Successful reading is signaled by an audible tone plus a good-read green spot LED indicator.

#### Relative Size and Location of Green Spot

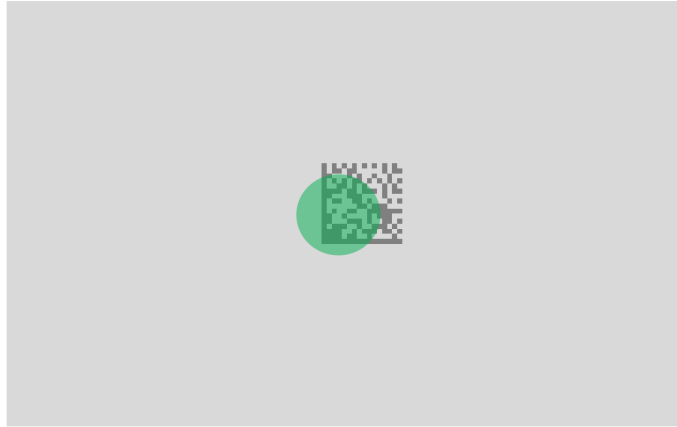

## LINKING THE READER

### Link Datalogic Devices to Base

Before configuring the interface it is necessary to link the handheld with the base.

To link the handheld and the base simply put it into the base. If the reader was previously linked to another base, you must first scan the Unlink bar code before re-linking to the new base.



Unlink

### Link Reader as Serial Device to a Bluetooth Host

Use this procedure to let the reader communicate with a Bluetooth host using the Bluetooth Serial Port Profile (SPP).

1. If using a Bluetooth adapter on the host device, install any driver provided with the adapter.
2. Scan the Link to Host in SPP mode label below to make the reader visible to the host device.
3. Use the Bluetooth manager of the host device to "Discover new devices" and select "GBT4500...". If you receive an error message, it may be necessary to change the security settings on either the host device or the reader.
4. Use an RS-232 terminal program to see incoming data on the port designated by the Bluetooth manager of the host device.



Link to Host in SPP Mode

### Link Reader as HID device to a Bluetooth host

Use this procedure to send data to a Bluetooth host using the Bluetooth HID profile.

1. If using a Bluetooth adapter on the host device, install any driver provided with the adapter.
2. Scan the Link to Host in HID mode label below to make the reader visible to the host device.
3. Use the Bluetooth manager of the host device to "Discover new devices" and select "GBT4500 ...". If you receive an error message, it may be necessary to change the security settings on either the host device or the reader.
4. On the host device, open the program that is meant to receive the incoming data.

The data transmitted by the reader will appear in the program as if it was typed using the keyboard of the host device.



Link to Host in HID mode



**NOTE:** The Gryphon I GBT4500 can be set up to authenticate the remote system when connecting, by entering a Bluetooth passkey or a PIN code. If you want to set the security level and authentication options suitable for your application, or when adding new equipment to a system that requires authentication or uses a custom security PIN, please see the "Bluetooth Security Level" on page 256.

## BLUETOOTH PASSKEY OR PIN CODE ENTRY REQUEST

During the pairing process, based on Host and Reader security settings, you may need to enter a Bluetooth passkey or PIN code.

When requested by the Host, simply enter the displayed code by scanning the corresponding bar codes for alphanumeric entry listed in [Appendix D](#). Complete by scanning the End label. To restart the entering of the passkey, read the Restart label.



Passkey END



Passkey Restart

## POWER OFF

Scan the bar code below to shut off power to the handheld until the next trigger pull.



Power Off

## INTERFACE SELECTION

Upon completing the physical connection between the reader and its host, proceed directly to "Configuring the Interface" on page 26 for information and programming for the interface type the reader is connected to (for example: RS-232, Keyboard Wedge, USB, etc.) and scan the appropriate bar code in that section to select your system's correct interface type.

The reader, depending upon the model, will support one of the following sets of host interfaces:

- USB (Keyboard, COM, OEM)
- USB Composite (Keyboard + COM)
- USB HID POS
- USB Toshiba TEC
- RS-232 STD
- RS-232 WN
- RS232 OPOS
- Keyboard Wedge (see note at page 7)
- IBM46XX port 9b (a specific cable is required)
- Datalogic Magellan Scanners' specific interface

## CONFIGURING THE INTERFACE



Scan the programming bar code from the following section which selects the appropriate interface type to match the system the reader will be connected to. Next, proceed to the corresponding chapter in this manual (also listed in the table) to configure any desired settings and features associated with that interface.





**NOTE: Unlike some other programming features and options, interface selections require that you scan only one programming bar code label. DO NOT scan an ENTER/EXIT bar code prior to scanning an interface selection bar code. Some interfaces require the reader to start in the disabled state when powered up. If additional reader configuration is desired while in this state, pull the trigger and hold for 5 seconds. The reader will change to a state that allows programming with bar codes.**









Table 3 - Available Interfaces

RS-232	
RS-232 standard interface <i>*Not supported on USB only models</i>	 Select RS232-STD
 Select RS232-WN	RS-232 Wincor-Nixdorf
RS-232 for use with OPOS/UPOS/JavaPOS	 Select RS-232 OPOS

USB-COM <sup>A</sup>	
 Select USB-COM-STD	USB-COM (simulates RS-232 standard interface)
USB-Composite (combines USB-KBD emulation and USB-COM)	 Select USB-Composite







a. USB-COM driver needs to be installed for these interfaces to work. Please download it from [www.datalogic.com](http://www.datalogic.com)

OTHER INTERFACES	
 Select IBM-P9B	IBM 46xx Port 9B interface
USB HID POS	 Select USB HID POS
 Select USB Toshiba TEC	USB Toshiba TEC
Datalogic Magellan Scanners' specific interface, USB AUX	 Select Datalogic Magellan Scanners' USB AUX
 Magellan RS232 AUX port	Datalogic Magellan RS232 AUX port

USB-OEM	
 Select USB-OEM	USB-OEM (can be used for OPOS/UPOS/JavaPOS)



**NOTE:** If you erroneously read the USB-OEM interface selection code, it is required to press and hold the trigger to unlock the reader. Then read the correct interface bar code. This will work only at power-up. Please reconnect the reader if the unlock is not successful.

KEYBOARD	
AT, PS/2 25-286, 30-286, 50, 50Z, 60, 70, 80, 90 & 95 w/Standard Key Encoding	 Select KBD-AT
 Select KBD-AT-NK	Keyboard Wedge for IBM AT PS2 with standard key encoding but without external keyboard
AT, PS/2 25-286, 30-286, 50, 50Z, 60, 70, 80, 90 & 95 w/Alternate Key	 Select KBD-AT-ALT
 Select KBD-AT-ALT-NK	Keyboard Wedge for IBM AT PS2 with alternate key encoding but without external keyboard
USB Keyboard with standard key encoding	 Select USB Standard Keyboard
 Select USB Alternative Keyboard	USB Keyboard with alternative key encoding



**NOTE: The Wedge interface is supported by products manufactured until June 2023.**

# CUSTOMIZING CONFIGURATION SETTINGS

## Using the Programming Bar Codes

This manual contains feature descriptions and bar codes which allow you to reconfigure your reader. Some programming bar code labels, like [Resetting the Product Configuration to Defaults, starting on page 31](#), require only the scan of that single label to enact the change.

Most of the programming labels in this manual, however, require the reader to be placed in Programming Mode prior to scanning them. Scan an ENTER/EXIT bar code once to enter Programming Mode. Once the reader is in Programming Mode, you can scan a number of parameter settings before scanning the ENTER/EXIT bar code a second time, which will then accept your changes, exit Programming Mode and return the reader to normal operation.



**NOTE: There are some exceptions to the typical programming sequence described above. Please read the description and setting instructions carefully when configuring each given programmable feature.**

## Datalogic Aladdin™ Utility

Programming can alternatively be performed using the Datalogic Aladdin™ Configuration application which is available for free download from the Datalogic website listed on the back cover of this manual. This multi-platform utility program allows device configuration using a PC. It communicates to the device using a serial or USB cable and can also create configuration bar codes to print.

Datalogic Aladdin™ is a multi-platform utility program providing a quick and user-friendly configuration method via the RS-232/USB-COM interface. The Aladdin utility is available on the Datalogic website. Aladdin allows you to program the reader by selecting configuration commands through a user-friendly graphical interface running on a PC. These commands are sent to the reader over the selected communication interface, or they can be printed as bar codes to be scanned.

Aladdin also provides the ability to perform a software upgrade for the connected device (see the Datalogic Aladdin™ Help On-Line for more details).

## Interface Settings

The reader is typically factory-configured with a set of default features standard to the interface type you ordered. See [Appendix B, Standard Defaults](#).

Global Interface Features, starting on [page 35](#) provides settings configurable by all interface types. If your installation requires you to further customize your reader, you can select other options through use of the instructions and programming bar codes available in the appropriate section for your interface.

- "RS-232 INTERFACE" on [page 36](#)
- "RS-232/USB-COM Interfaces" on [page 41](#)
- RS232 OPOS on [page 27](#)
- USB Composite (COM + Keyboard) on [page 27](#)
- KEYBOARD INTERFACE on [page 49](#)
- USB-OEM INTERFACE on [page 78](#)

## Configuring Other Features

If your installation requires different programming than the standard factory default settings, the following sections of this manual allow configuration of non-interface-specific settings you might require:

**Configuration Using Bar Codes:** General Features includes programming for scanning, beeper and LED indicators and other such universal settings.

**Reading Parameters:** Reading Parameters include programming for scanning, beeper and LED indicators and other universal settings.

**1D Symbologies:** Includes options concerning the bar code label types (symbologies). These settings allow you to enable/disable symbologies, set label lengths, require check digit, etc.

## Software Version Transmission

The software version of the device can be transmitted over the RS-232, Keyboard and USB interfaces by scanning the following label.



Transmit Software Version

## Resetting the Product Configuration to Defaults

### Restore Custom Default Configuration

If you aren't sure what programming options are in your reader, or you've changed some options and want to restore the Custom Default Configuration that may have been saved in the reader, scan the Restore Custom Default Configuration bar code below. This will restore the custom configuration for the currently active interface.



**NOTE: Custom defaults are based on the interface type. Configure the reader for the correct interface before scanning this label.**



Restore Custom Default Configuration

## Restore Factory Configuration

If you want to restore the Factory Configuration for your reader, scan either the Restore USA Factory Configuration bar code or the Restore EU Factory Configuration bar code below. Both labels restore the reader configuration to the factory settings, including the interface type. The USA label restores Label IDs to those historically used in the USA. The EU label restores Label IDs to those historically used in Europe. The Label ID sets for USA and EU are shown in the “Label ID” Section on [page 87](#) of this manual.



Restore USA Factory Configuration



Restore EU Factory Configuration

The programming items listed in the following sections show the factory default settings for each of the menu commands.

# CHAPTER 3

## CONFIGURATION WITH BAR CODES

---

This and following sections provide programming bar codes to configure your reader by changing the default settings. For details about additional methods of programming, see "Customizing Configuration Settings" on page 30.



**NOTE: You must first enable your PowerScan to read bar codes in order to use this section. If you have not done this, go to Setup, starting on page 5 and complete the appropriate procedure.**

### CONFIGURATION PARAMETERS

Once the reader is set up, you can change the default parameters to meet your application needs. Refer to [Standard Defaults, starting on page 313](#) for initial configuration in order to set the default values and select the interface for your application.



**NOTE: In the following sections, text shown with a green star indicates a factory default value.**

★ This is an example of a default value.

The following configuration parameters are divided into logical groups, making it easy to find the desired function based on its reference group.

#### Interface Configuration:

- [RS-232 Standard Settings, starting on page 37](#)
- [RS-232/USB-COM Settings, starting on page 42](#)
- [Keyboard Interface, starting on page 49](#)
- [USB-OEM Interface, starting on page 78](#)

#### Parameters common to all interface applications:

- [Global Prefix/Suffix, starting on page 83](#)
- [Data Format, starting on page 82](#) gives options to control the messages sent to the Host system by selecting parameters to control the message strings sent to the handheld.
- [Reading Parameters, starting on page 93](#) controls various operating modes and indicators status functioning.

## Symbology-specific parameters:

1D Symbologies, starting on page 118 and 2D Symbologies, starting on page 208 define options for all symbologies and provides the programming bar codes necessary for configuring these features.



**NOTE: You must first enable your reader to read bar codes in order to use this section. If you have not done this, go to Setup, starting on page 5 and complete the appropriate procedure.**

## To program features:

1. Scan the ENTER/EXIT PROGRAMMING bar code, available at the top of each programming page, when applicable.
2. Scan the bar code to set the desired programming feature. You may need to cover unused bar codes on the page, and possibly the facing page, to ensure that the reader reads only the bar code you intend to scan.
3. If additional input parameters are needed, go to [Appendix D](#), and scan the appropriate characters from the keypad.



**NOTE: Additional information about many features can be found in the References, starting on page 269.**

**If you make a mistake before the last character, scan the CANCEL bar code to abort and not save the entry string. You can then start again at the beginning.**

4. Complete the programming sequence by scanning the ENTER/EXIT PROGRAMMING bar code to exit Programming Mode.

For more detailed descriptions, programming information and examples for setting selected configuration items, see [References, starting on page 269](#).





## GLOBAL INTERFACE FEATURES

The following interface features are configurable by all interface types.

To set features specific to your interface, turn to that section of this manual.

### Host Commands — Obey/Ignore

This option specifies whether the reader will obey or ignore host commands. When set to ignore, the reader will ignore all host commands except those necessary for:

- service mode
- flash programming mode
- keeping the interface active
- transmission of labels.



★ Host Commands = Obey  
(Do Not Ignore Host Commands)



Host Commands = Ignore

### USB Suspend Mode

This setting enables/disables the ability of USB interfaces to enter suspend mode.



USB Suspend Mode = Disable



★ USB Suspend Mode = Enable

# CONFIGURATION | RS-232 INTERFACE

Use the programming bar codes in this chapter if modifications to the standard RS-232 interface settings are necessary to meet your system's requirements. Additional settings which apply to both the RS-232 and USB interfaces are available in [RS-232/USB-COM Settings](#), starting on page 42.

## SECTION CONTENTS

### **RS-232 STANDARD SETTINGS** starting on page 37

- Baud Rate
- Data Bits
- Stop Bits
- Parity
- Handshaking Control

#### **Standard Factory Settings**

Reference [Appendix B](#), for a listing of standard factory settings.



## RS-232 STANDARD SETTINGS

### Baud Rate

Baud rate is the number of bits of data transmitted per second. Set the reader's baud rate to match the baud rate setting of the host device. With an improper baud rate setting, data may not reach the host correctly.



Baud Rate = 1200



Baud Rate = 2400



Baud Rate = 4800



★ Baud Rate = 9600



Baud Rate = 19,200



Baud Rate = 38,400



Baud Rate = 57,600



Baud Rate = 115,200



## Data Bits

This parameter allows the reader to interface with devices requiring a 7-bit or 8-bit ASCII protocol for sending and receiving data.



7 Data Bits



★ 8 Data Bits



**NOTE: Handheld and base station models support the 8-bit ASCII protocol. The 7-bit ASCII protocol support is subject to specific firmware release. If the setting is not supported, the reader will emit three short beeps upon scanning the label.**

## Stop Bits

The stop bit(s) at the end of each transmitted character marks the end of transmission of one character and prepares the receiving device for the next character in the serial data stream. The number of stop bits selected (one or two) depends on the number the receiving terminal is programmed to accommodate. Set the number of stop bits to match host device requirements..



★ 1 Stop Bit



2 Stop Bits



## Parity

This feature specifies parity required for sending and receiving data. A parity check bit is the most significant bit of each ASCII coded character. Select the parity type according to host device requirements.

- Select None when no parity bit is required.
- Select Odd parity and the parity bit value is set to 0 or 1, based on data, to ensure that an odd number of 1 bits are contained in the coded character.
- Select Even parity and the parity bit value is set to 0 or 1, based on data, to ensure that an even number of 1 bits are contained in the coded character.



★ Parity = None



Parity = Even



Parity = Odd



## Handshaking Control

The data interface consists of an RS-232 port designed to operate either with or without the hardware handshaking lines, Request to Send (RTS), and Clear to Send (CTS). Handshaking Control includes the following options:

- RTS — RTS is asserted during transmissions. CTS is ignored.
- RTS/CTS — RTS is asserted during transmissions. CTS gates transmissions.
- RTS/XON/XOFF — RTS is asserted during transmissions. CTS is ignored. XON and XOFF gate transmissions.
- RTS On/CTS — RTS is always asserted. CTS gates transmissions.
- RTS/CTS Scan Control — RTS is asserted during transmissions. CTS gates transmissions and controls enable and disable state of reader.



★ Handshaking Control = RTS



Handshaking Control = RTS/CTS



Handshaking Control = RTS/XON/XOFF



Handshaking Control = RTS On/CTS



Handshaking Control = RTS/CTS Scan Control



Handshaking Control = RTS Off

# CONFIGURATION | RS-232/USB-COM INTERFACES

## SECTION CONTENTS

- Intercharacter Delay
- Beep On ASCII BEL
- Beep On Not on File
- ACK NAK Options
- ACK Character
- NAK Character
- ACK NAK Timeout Value
- ACK NAK Retry Count
- ACK NAK Error Handling
- Indicate Transmission Failure
- Disable Character
- Enable Character

### Standard Factory Settings

Reference [Appendix B](#), for a listing of standard factory settings.



## RS-232/USB-COM SETTINGS

### Intercharacter Delay

This parameter specifies the intercharacter delay between the end of one character and the beginning of the next. The delay can be set within a range of zero (0) to 990 milliseconds in 10ms increments. A setting of zero specifies no delay. See "[Intercharacter Delay](#)" on [page 271](#) for more detailed programming instructions.



Intercharacter Delay = No Delay



Select Intercharacter Delay Setting

To configure this feature, scan the ENTER/EXIT bar code above, then the bar code at left followed by digits from the Alphanumeric characters in [Appendix D](#) representing your desired character(s). End by scanning the ENTER/EXIT bar code again.

Make a mistake? Scan the CANCEL bar code to abort and not save the entry string. You can then start again at the beginning.



CANCEL

★00 = No Intercharacter Delay





## Beep On ASCII BEL

When this parameter is enabled, the reader issues a beep when a <BEL> character is detected on the RS-232 serial line. <BEL> is issued to gain a user's attention to an illegal entry or other important event.



★ Beep On ASCII BEL = Disable



Beep On ASCII BEL = Enable

## Beep On Not on File

This option enables/disables the action of the reader to sound a three beep sequence upon receiving a Not-On-File (NOF) host command.



Beep On Not On File = Disable



★ Beep On Not On File = Enable



## ACK NAK Options

This enables/disables the ability of the reader to support the RS-232 ACK/NAK protocol. When configured, the reader and/or host sends an “ACK” when it receives data properly, and sends “NAK” when the data is in error.

Options are:

- Disable
- Enable for label transmission — The reader expects an ACK/NAK response from the host when a label is sent.
- Enable for host-command acknowledge — The reader will respond with ACK/NAK when the host sends a command.
- Enable for label transmission and host-command acknowledge



★ ACK/NAK Protocol = Disable ACK/NAK



ACK/NAK Protocol = Enable for label transmission



ACK/NAK Protocol = Enable for host-command  
acknowledge



ACK/NAK Protocol = Enable for label transmission and  
host command acknowledge



## ACK Character

This setting specifies an ASCII character or hex value to be used as the ACK character. ASCII characters or any hex value from 0 to 0xFF can be selected. See "ACK Character" on page 272 for more detailed programming instructions.



**NOTE: Setting to previously defined characters such as XON, XOFF, or host commands conflicts with normal operation of these characters. 8-bit data is not recognized when the option "Data Bits" on page 38 has been set as 7 Data Bits.**



Select ACK Character Setting

Make a mistake? Scan the CANCEL bar code to abort and not save the entry string. You can then start again at the beginning.



CANCEL

★ 0x06 'ACK' Character

## NAK Character

This setting specifies an ASCII character or hex value to be used as the NAK character. ASCII characters or any hex value from 0 to 0xFF can be selected. See "NAK Character" on page 273 for more detailed programming instructions.



**NOTE: Setting to previously defined characters such as XON, XOFF, or host commands conflicts with normal operation of these characters. 8-bit data is not recognized when the option "Data Bits" on page 38 has been set as 7 Data Bits.**



Select NAK Character Setting

Make a mistake? Scan the CANCEL bar code to abort and not save the entry string. You can then start again at the beginning.



CANCEL

★ 0x15 'NAK' Character



## ACK NAK Timeout Value

This option specifies the amount of time the reader waits for an ACK character from the host following label transmission. The selectable timeout range is 200 milliseconds to 15,000ms (15 seconds) in 200ms increments. A selection of 0 disables the timeout. See "[ACK NAK Timeout Value](#)" on page 274 for more detailed programming instructions.



Select ACK NAK Timeout Value Setting

To configure this feature, scan the ENTER/EXIT bar code above, then the bar code at left followed by digits from the Alphanumeric characters in [Appendix D](#) representing your desired character(s). End by scanning the ENTER/EXIT bar code again.

Make a mistake? Scan the CANCEL bar code to abort and not save the entry string. You can then start again at the beginning.



CANCEL

★01 ACK NAK Timeout value is 200ms

## ACK NAK Retry Count

This feature specifies the number of times the reader retries a label transmission due to a retry condition. The selectable range is from 1 to 254 retries. A selection of 0 disables the count, and a selection of 255 specifies unlimited retries. See "[ACK NAK Retry Count](#)" on page 275 for more detailed programming instructions.



Select ACK NAK Retry Count Setting

To configure this feature, scan the ENTER/EXIT bar code above, then the bar code at left followed by digits from the Alphanumeric characters in [Appendix D](#) representing your desired character(s). End by scanning the ENTER/EXIT bar code again.

Make a mistake? Scan the CANCEL bar code to abort and not save the entry string. You can then start again at the beginning.



CANCEL

★003 = 3 Retries



## ACK NAK Error Handling

This feature specifies the method the reader uses to handle receive errors detected while waiting for an ACK character from the host.

Options are:

- Ignore errors detected
- Process error as valid ACK character
- Process error as valid NAK character



★ ACK NAK Error Handling = Ignore Errors Detected



ACK NAK Error Handling = Process Error as  
Valid ACK Character



ACK NAK Error Handling = Process Error as  
Valid NAK Character

## Indicate Transmission Failure

This option enables/disables the reader's ability to sound an error beep to indicate a transmission failure while in ACK/NAK mode.



Indicate Transmission Failure = Disable Indication



★ Indicate Transmission Failure = Enable Indication



## Disable Character

Specifies the value of the RS-232 host command used to disable the reader.

ASCII characters or any hex value from 0 to 0xFF can be selected. See "Disable Character" on page 276 for more detailed programming instructions.



**Setting to previously defined characters such as XON, XOFF, or host commands conflicts with normal operation of these characters.**



Select Disable Character Setting

Make a mistake? Scan the CANCEL bar code to abort and not save the entry string. You can then start again at the beginning.



CANCEL

★ 0x44 = Disable Character is 'D'

## Enable Character

Specifies the value of the RS-232 host command used to enable the reader.

ASCII characters or any hex value from 0 to 0xFF can be selected. See "Enable Character" on page 277 for more detailed programming instructions



**Setting to previously defined characters such as XON, XOFF, or host commands conflicts with normal operation of these characters.**



Select Enable Character Setting

Make a mistake? Scan the CANCEL bar code to abort and not save the entry string. You can then start again at the beginning.



CANCEL

★ 0x45 = Enable Character is 'E'

# CONFIGURATION | KEYBOARD INTERFACE

## SECTION CONTENTS

### **COUNTRY MODE** starting on page 50

- Setting Country Mode

### **OTHER KEYBOARD PARAMETERS** starting on page 65

- Encoding Type
- ALT Output Type
- Caps Lock State
- Numlock
- Keyboard Numeric Keypad
- Keyboard Send Control Characters
- Wedge Quiet Interval
- Intercharacter Delay
- Intercode Delay
- USB Keyboard Speed

Use the programming bar codes in this chapter to select options for USB Keyboard and Wedge Interfaces. Reference [Appendix B](#), for a listing of standard factory settings. Information about control character emulation which applies to keyboard interfaces is listed in [Appendix E](#), Scancode Tables.

# COUNTRY MODE

This feature specifies the country/language supported by the keyboard.

The Country Mode setting is ignored if the interface uses alternate key encoding.

## SETUP ON PC TO USE ALT UNIVERSAL

1. Open Registry Edit

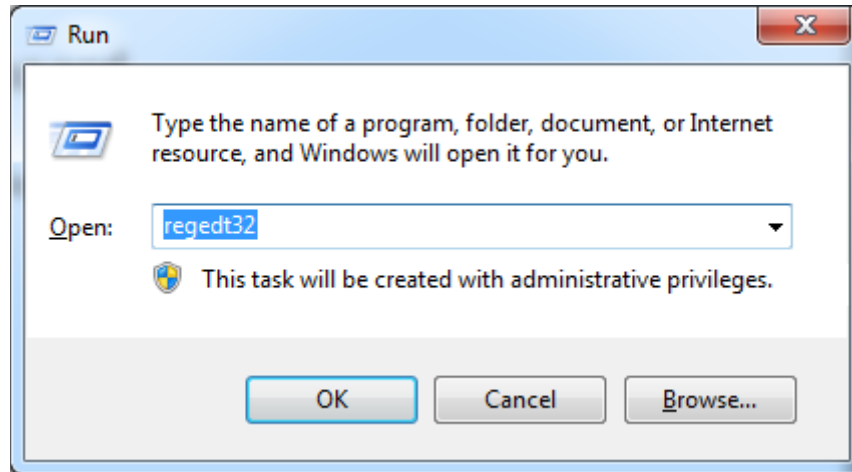

2. Set EnableHexNumpad to 1 as follows:

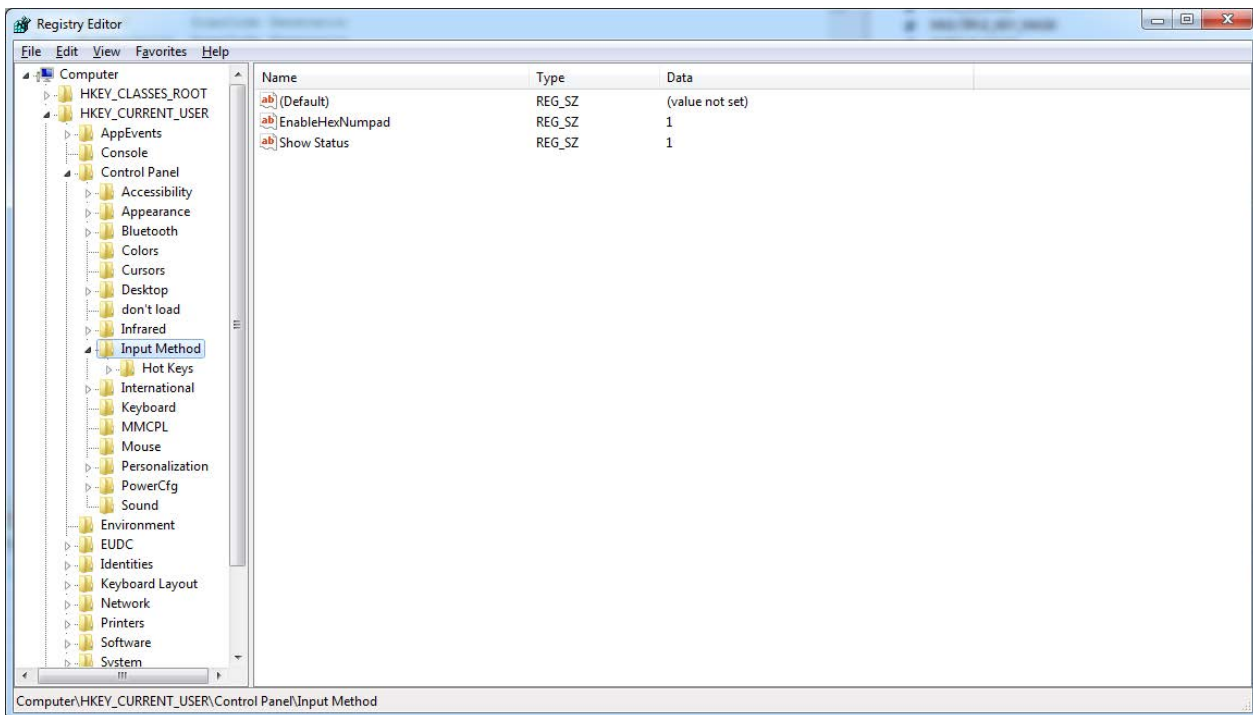

3. Reset the PC.





## Setting Country Mode



★ United States



French International (Belgian French)



United Kingdom



Danish



French (France)



German



Italian



### Setting Country Mode (continued)



Norwegian



Portuguese (Portugal)



Spanish



Swedish



Swiss French



Japanese ASCII



Hungarian



### Setting Country Mode (continued)



Czech



Slovak



Romanian



Croatian



Polish\_214



French Canadian Win7



Lithuanian



### Setting Country Mode (continued)



Vietnamese



Russian



Arabic 101



Chinese ASCII



Thai-Kedmanee



Albanian



Arabic 102



### Setting Country Mode (continued)



Arabic 102 AZERTY



Azeri Cyrillic



Azeri Latin



Belarusian



Bosnian Cyrillic



Bosnian Latin



Bulgarian Cyrillic



## Setting Country Mode (continued)



Bulgarian Latin



Canadian French (Legacy)



Canadian Multilingual



Chinese (Simplified)



Chinese (Traditional)



Czech Programmers



Czech QWERTY



### Setting Country Mode (continued)



Dutch Netherland



Estonian



Faeroese



Finnish



French (Canada) 2000/XP



French (Canada) 95/98



Galician



### Setting Country Mode (continued)



Greek



Greek Latin



Greek Polytonic



Greek220



Greek220 Latin



Greek319



Greek319 Latin





### Setting Country Mode (continued)



Hebrew Israel



Hungarian\_101KEY



Icelandic



Irish



Italian\_142



Japanese (Shift-JIS)



Kazakh



### Setting Country Mode (continued)



Korean (Hangul)



Korean ASCII



Kyrgyz Cyrillic



Latin America



Latvian



Latvian QWERTY



Lithuanian\_IBM



### Setting Country Mode (continued)



Macedonian -FYROM



Maltese\_47KEY



Mongolian-Cyrillic



Polish Programmer



Portuguese Brazil



Portuguese Brazilian ABNT



Portuguese Brazilian ABNT2



### Setting Country Mode (continued)



Romanian Legacy



Romanian Programmer



Romanian Standard



Russian Typewriter



Serbian Cyrillic



Serbian Latin



Slovak QWERTY



### Setting Country Mode (continued)



Slovenian



Spanish Variation



Swiss German



Tatar



Turkish F



Turkish Q



Ukrainian



### Setting Country Mode (continued)



US Dvorak



US Dvorak Left Hand



US Dvorak Right Hand



US English (Mac)



US English (North American)



US International



Uzbek Cyrillic



## OTHER KEYBOARD PARAMETERS

### Encoding Type



★ Encoding Type = Don't Use Encoding



Encoding Type = UTF\_8



Encoding Type = Windows 874



Encoding Type = Windows 932



Encoding Type = Windows 936



Encoding Type = Windows 949



Encoding Type = Windows 950



### Encoding Type (continued)



Encoding Type = Windows 1250



Encoding Type = Windows 1251



Encoding Type = Windows 1252



Encoding Type = Windows 1253



Encoding Type = Windows 1254



Encoding Type = Windows 1255



Encoding Type = Windows 1256





### Encoding Type (continued)



Encoding Type = Windows 1257



Encoding Type = Windows 1258



Encoding Type = Windows 20866



Encoding Type = Windows 54936



Encoding Type = ISO 8859-1



Encoding Type = ISO 8859-2



Encoding Type = ISO 8859-3



### Encoding Type (continued)



Encoding Type = ISO 8859-4



Encoding Type = ISO 8859-5



Encoding Type = ISO 8859-6



Encoding Type = ISO 8859-7



Encoding Type = ISO 8859-8



Encoding Type = ISO 8859-9



Encoding Type = ISO 8859-10



### Encoding Type (continued)



Encoding Type = ISO 8859-11



Encoding Type = ISO 8859-13



Encoding Type = ISO 8859-14



Encoding Type = ISO 8859-15



Encoding Type = ISO 8859-16



Encoding Type = MS-DOS 437



Encoding Type = MS-DOS 737



### Encoding Type (continued)



Encoding Type = MS-DOS 775



Encoding Type = MS-DOS 850



Encoding Type = MS-DOS 852



Encoding Type = MS-DOS 855



Encoding Type = MS-DOS 857



Encoding Type = MS-DOS 860



Encoding Type = MS-DOS 861



### Encoding Type (continued)



Encoding Type = MS-DOS 862



Encoding Type = MS-DOS 863



Encoding Type = MS-DOS 865



Encoding Type = MS-DOS 866



Encoding Type = MS-DOS 869



Encoding Type = Mac CP10000



## ALT Output Type

This option specifies the encode type of ALT Mode when the reader sends Output Keyboard Data in Alt Mode. (Be aware that the reader may switch automatically between ALT mode & Normal Keyboard Scancode, to correctly display some characters that are not present in the current Keyboard Country).



ALT Output Type = ALT Codepage  
(use on non Unicode application: Notepad)



★ ALT Output Type = ALT Unicode  
(use on Unicode application: Word)



ALT Output Type = ALT Universal  
(Use for all)



ALT Output Type = ALT Unicode for Linux



## Caps Lock State

This option specifies the format in which the reader sends character data. This applies to Keyboard Wedge interfaces. This does not apply when an alternate key encoding keyboard is selected. This does not apply to USB Keyboard.



★ Caps Lock State = Caps Lock OFF



Caps Lock State = Caps Lock ON



Caps Lock State = AUTO Caps Lock Enable

## Numlock

This option specifies the setting of the Numbers Lock (Numlock) key while in Keyboard Wedge interface. This only applies to alternate key encoding interfaces. It does not apply to USB Keyboard.



★ Numlock = Numlock key unchanged



Numlock = Numlock key toggled



## Keyboard Numeric Keypad

This feature specifies if numeric characters will be sent using the standard keys or the numeric keypad.



★ Keyboard Numeric Keypad = Standard Keys



Keyboard Numeric Keypad = Numeric Keypad

## Keyboard Send Control Characters

This feature is used by the Keyboard Wedge and USB Keyboard interfaces. It specifies how the reader transmits ASCII control characters to the host. Reference [Appendix E Scancode Tables](#) for more information about control characters.

Options are as follows:

**Send Ctrl+Key :** ASCII characters from 00H to 0x1FH inclusive are transmitted in the format Ctrl+Key. Special keys are available in the range from 81H to A1.

**Send Ctrl+Shift+Key :** The behavior is the same as above, but control keys are sent in the format Ctrl+Shift+Keys.

**Send Special Function Key :** Send characters between 00H and 1FH according to the special function key mapping table (see "[Interface Type PC AT PS/2 Alt Mode or USB-Key-board Alt Mode](#)" on page 339). This is used to send keys that are not in the normal ASCII set. A unique set is provided for each available scancode set.



★ Keyboard Send Control Characters = Send Ctrl+Key



Keyboard Send Control Characters = Send Ctrl+Shift+Key



Keyboard Send Control Characters = Send Special Function Key





## Wedge Quiet Interval

This option specifies the amount of time to look for keyboard activity before the reader breaks the keyboard connection in order to transmit data to host. The selectable range for this feature is from 0 to 990ms in 10ms increments. See "[Wedge Quiet Interval](#)" on [page 278](#) for more detailed programming instructions.



**NOTE: This feature applies ONLY to the Keyboard Wedge interface.**



Select Wedge Quiet Interval Setting

To configure this feature, scan the ENTER/EXIT bar code above, then the bar code at left followed by digits from the Alphanumeric characters in [Appendix D](#), Keypad representing your desired character(s). End by scanning the ENTER/EXIT bar code again.

Make a mistake? Scan the CANCEL bar code to abort and not save the entry string. You can then start again at the beginning.



CANCEL

★10 = Quiet Interval of 100 msec



## Intercharacter Delay

This parameter specifies the intercharacter delay between the end of one character and the beginning of the next. The delay can be set within a range of zero (0) to 990 milliseconds in 10ms increments. A setting of zero specifies no delay. See "Intercharacter Delay" on page 279 for more detailed programming instructions.



**NOTE: This feature applies ONLY to the Keyboard Wedge interface.**



Intercharacter Delay = No Delay



Select Intercharacter Delay Setting

To configure this feature, scan the ENTER/EXIT bar code above, then the bar code at left followed by digits from the Alphanumeric characters in [Appendix D](#), Keypad representing your desired character(s). End by scanning the ENTER/EXIT bar code again.

Make a mistake? Scan the CANCEL bar code to abort and not save the entry string. You can then start again at the beginning.



CANCEL

★00 = No Intercharacter Delay

## Intercode Delay

Specifies the delay between labels transmitted to the host for this interface. The selectable range for this feature is from 0 to 99 seconds. See "Intercode Delay" on page 280 for more detailed programming instructions



Set Intercode Delay

To configure this feature, scan the ENTER/EXIT PROGRAMMING MODE bar code above, then the bar code at left followed by the digits from the Alphanumeric characters in [Appendix D](#), Keypad representing your desired character(s). End by scanning the ENTER/EXIT bar code again.

Make a mistake? Scan the CANCEL bar code to abort and not save the entry string. You can then start again at the beginning.



CANCEL

★00 = No Wedge Intercode Delay



## USB Keyboard Speed

This option specifies the USB poll rate for a USB Keyboard.



**NOTE: This feature applies ONLY to the USB Keyboard interface.**



★ USB Keyboard Speed = 1ms



USB Keyboard Speed = 2ms



USB Keyboard Speed = 3ms



USB Keyboard Speed = 5ms



USB Keyboard Speed = 7ms



USB Keyboard Speed = 10ms

# CONFIGURATION | USB-OEM INTERFACE

## SECTION CONTENTS

- USB-OEM Device Usage

- USB-OEM Interface Options



## USB-OEM Device Usage

The USB-OEM protocol allows for the reader to be identified as one of two different types of bar code reader. Depending on what other reader you may already have connected to a USB-OEM POS, you may need to change this setting to enable all devices to communicate.

Options are:

- Tabletop Scanner
- Handheld Scanner



**NOTE: This feature is not compatible with Multiple Labels Reading in a Volume.**



USB-OEM Device Usage = Tabletop Scanner



★ USB-OEM Device Usage = Handheld Scanner

## USB-OEM Interface Options

This setting provides for an interface specific control mechanism.

Options are:

- Obey — Obey Scanner Configuration Host Commands
- Ignore — Ignore Scanner Configuration Host Commands



★ Interface Options = Obey Scanner Configuration Host Commands



Interface Options = Ignore Scanner Configuration Host Commands

# CONFIGURATION | IBM 46XX INTERFACE

## SECTION CONTENTS

- IBM 46xx Interface Options



## IBM 46xx Interface Options

This setting provides for an interface specific control mechanism.

Options are:

- Obey — Obey Scanner Configuration Host Commands
- Ignore — Ignore Scanner Configuration Host Commands



★ Interface Options = Obey Scanner Configuration  
Host Commands



Interface Options = Ignore Scanner Configuration  
Host Commands

# CONFIGURATION | DATA FORMAT

## SECTION CONTENTS

### **GLOBAL SETTINGS** starting on page 83

- Global Prefix/Suffix
- Case Conversion
- Character Conversion
- Global AIM ID
- GS1-128 AIM ID

### **LABEL ID** starting on page 86

- Label ID: Set Individually Per Symbology
- Label ID Control
- Label ID Symbology Selection





## GLOBAL SETTINGS

### Global Prefix/Suffix

Up to 20 ASCII characters may be added as a prefix (in a position before the bar code data) and/or as a suffix (in a position following the bar code data). See [page 282](#) in “References” for more detailed programming instructions.

To configure, scan the ENTER/EXIT PROGRAMMING MODE bar code above, then the bar code at left followed by the digits from the Alphanumeric characters in [Appendix D, Keypad](#) representing your desired character(s). End by scanning the ENTER/EXIT bar code.



Set Global Prefix



Set Global Suffix

To configure, scan the ENTER/EXIT PROGRAMMING MODE bar code above, then the bar code at left followed by the digits from the Alphanumeric characters in [Appendix D, Keypad](#) representing your desired character(s). End by scanning the ENTER/EXIT bar code.

Make a mistake? Scan the CANCEL bar code to abort and not save the entry string. You can then start again at the beginning.



CANCEL

★ No Global Prefix

★ Global Suffix = Global Suffix = 0x0D(CR)



## Case Conversion

This feature allows conversion of the case of all alphabetic characters to upper or lower case.



**NOTE: Case conversion affects ONLY scanned bar code data, and does not affect Label ID, Prefix, Suffix, or other appended data.**



★ Case Conversion = Disable (no case conversion)



Case Conversion = Convert to upper case



Case Conversion = Convert to lower case

## Character Conversion

Character conversion is an eight byte configuration item. The eight bytes are 4 character pairs represented in hexadecimal ASCII values. The first character in the pair is the character that will be converted. The second character in the pair is the character to convert to. If the character to convert in a pair is FF, then no conversion is done. See [page 288](#) in “References” for more detailed programming instructions.



Configure Character Conversion

To configure, scan the ENTER/EXIT PROGRAMMING MODE bar code above, then the bar code at left followed by the digits from the Alphanumeric characters in [Appendix D, Keypad](#) representing your desired character(s). End by scanning the ENTER/EXIT bar code.

Make a mistake? Scan the CANCEL bar code to abort and not save the entry string. You can then start again at the beginning.



CANCEL

★ 0xFFFFFFFFFFFFFFF  
(no character conversion)



## Global AIM ID



**NOTE: This feature enables/disables addition of AIM IDs for all symbology types.**

AIM label identifiers (as opposed to custom characters you select yourself as with label identifiers) can be included with scanned bar code data. See for more detailed programming instructions.



★ Global AIM ID = Disable



Global AIM ID = Enable

## GS1-128 AIM ID

If Global AIM ID is disabled, the AIM ID for GS1-128 can be enabled/disabled independently. The AIM ID for GS1-128 is a ]C1, ]C2.

AIM IDs for other symbologies can be enabled/disabled independently as well. Contact Customer Support for assistance.



★ Global AIM ID = Disable



Global AIM ID = Enable



## LABEL ID

A Label ID is a customizable code of up to three ASCII characters (each can be one of hex 0x01-0xFF), used to identify a bar code (symbology) type. It can be appended previous to or following the transmitted bar code data depending upon how this option is enabled. This feature provides options for configuring custom Label IDs as a pre-loaded set (see [Label ID: Pre-loaded Sets](#) below) or individually per symbology (see "[Label ID: Set Individually Per Symbology](#)" on page 87). If you wish to program the reader to always include an industry standard label identifier for ALL symbology types, see the previous feature "[Global AIM ID](#)" on page 85.

### Label ID: Pre-loaded Sets

The reader supports two pre-loaded sets of Label IDs, the USA set and the EU set. See "[Label ID: Pre-loaded Sets](#)" on page 284 for more information concerning the pre-loaded sets that are provided.



**CAUTION: When changing from one Label ID set to another, all other reader configuration settings, including the host interface type, will be erased and set to the factory defaults. Any custom configuration or custom defaults will be lost.**



★ Label ID Pre-loaded Set = USA Set



Label ID Pre-loaded Set = EU Set



## Label ID: Set Individually Per Symbology

This feature configures a Label ID individually for a single symbology.



**NOTE: This setting requires the scanning of bar codes from multiple sections. See "Label ID: Set Individually Per Symbology" on page 286 for more detailed programming instructions.**

## Label ID Control

This option controls whether a Label ID is disabled, or sent as a prefix or suffix for a given symbology type.



★ Label ID Transmission = Disable



Label ID Transmission = Enable as Prefix



Label ID Transmission = Enable as Suffix



## Label ID Symbology Selection

This option selects the symbology for which a Label ID is to be configured. See "[Label ID: Set Individually Per Symbology](#)" on page 286 for full instructions.

Make a mistake? Scan the CANCEL bar code to abort and not save the entry string. You can then start again at the beginning.



CANCEL



Set UPC-A Label ID Character(s)



Set UPC-A/P2 Label ID Character(s)



Set UPC-A/P5 Label ID Character(s)



Set UPC-E Label ID Character(s)



Set UPC-E/P2 Label ID Character(s)



Set UPC-E/P5 Label ID Character(s)



Set EAN-13 Label ID Character(s)



### Label ID Symbology Selection (continued)



Set EAN-13/P2 Label ID Character(s)



Set EAN-13/P5 Label ID Character(s)



Set ISBN Label ID Character(s)



Set ISSN Label ID Character(s)



Set EAN-8 Label ID Character(s)



Set EAN-8 Label ID Character(s)



Set EAN-8 Label ID Character(s)



Set GS1 DataBar Omnidirectional Label ID Character(s)



### Label ID Symbology Selection (continued)



Set GS1 DataBar Expanded Label ID Character(s)



Set GS1 DataBar Limited Label ID Character(s)



Set Code 39 Label ID Character(s)



Set Code 32 Label ID Character(s)



Set Code 39 CIP HR Label ID Character(s)



Set Code 128 Label ID Character(s)



Set Code GS1-128 Label ID Character(s)



Set Interleaved 2 of 5 Label ID Character(s)





**Label ID Symbology Selection (continued)**



Set Interleaved 2 of 5 CIP HR Label ID Character(s)



Datalogic 2 of 5 Label ID Character(s)



Standard 2 of 5 Label ID Character(s)



Industrial 2 of 5 Label ID Character(s)



IATA Label ID Character(s)



Codabar Label ID Character(s)



ABC Codabar Label ID Character(s)



ISBT 128 Label ID Character(s)  
(single and concatenated)



## Label ID Symbology Selection (continued)



Code 11 Label ID Character(s)



MSI Label ID Character(s)



Plessey Label ID Character(s)



Anker Plessey Label ID Character(s)



Set Matrix 2 of 5 Label ID Character(s)

# CONFIGURATION | READING PARAMETERS

## SECTION CONTENTS

### **SCANNING FEATURES** starting on page 94

- Scan Mode
- Scanning Active Time
- Flash On Time
- Flash Off Time
- Double Read Timeout
- Stand /Base Detection Behavior
- Stand Mode/Object Detection Indication (Stand Mode Flash)
- Stand Mode/Object Detection Sensitivity
- Stand Mode/Object Detection Illumination Off Time
- Illumination Intensity
- Illuminator Refresh Frequency
- Corded Stand Mode
- Dock Detection Beep
- Corded Stand Beep

### **LED AND BEEPER INDICATORS** starting on page 103

- Power On Alert
- Good Read Beep Type
- Good Read Beep Frequency
- Good Read Beep Length
- RGB Good Read Enable
- RGB Good Read Color
- Good Read LED Duration
- Good Read Beeper Volume / Vibration
- Vibration Feedback for Good Read
- Silent Mode
- Good Read: When to Indicate
- Green Spot Duration

### **CAMERA CONTROL** starting on page 112

- Aiming Pointer
- Aiming Duration Timer
- Pick Mode
- Mobile Phone Mode
- Mobile Phone Saturation Rate
- Decode Negative Image
- Image Capture

### **MULTIPLE LABEL READING** starting on page 116

- Multiple Labels per Frame
- Multiple Labels Ordering by Code Symbology
- Multiple Labels Ordering by Code Length



# SCANNING FEATURES

## Scan Mode

Selects the reader's scan operating mode. See [page 289](#) in "References" for descriptions.



★ Scan Mode = Trigger Single



Scan Mode = Trigger Hold Multiple



Scan Mode = Trigger Pulse Multiple



Scan Mode = Flashing



Scan Mode = Always On



Scan Mode = Object Detection



Scan Mode = Trigger Object Sense



## Scanning Active Time

This setting specifies the amount of time that the reader stays in scan ON state once the state is entered. The range for this setting is from 1 to 255 seconds in 1-second increments. See [page 290](#) in “References” for further description of this feature.



Scanning Active Time = 3 seconds



★ Scanning Active Time = 5 seconds



Scanning Active Time = 8 seconds

## Flash On Time

This feature specifies the ON time for the indicator LED while in Flash Mode. The selectable range is 100 to 9,900 milliseconds (0.1 to 9.9 seconds), in 100 millisecond increments. See [page 292](#) in “References” for detailed information on setting this feature.



Select Flash ON Time Setting

To configure this feature, scan the ENTER/EXIT PROGRAMMING MODE bar code above, then the bar code at left followed by the digits from the Alphanumeric characters in [Appendix D, Keypad](#) representing your desired character(s). End by scanning the ENTER/EXIT bar code again.

Make a mistake? Scan the CANCEL bar code to abort and not save the entry string. You can then start again at the beginning.



CANCEL

★ 10 = Flash is ON for 1 Second



## Flash Off Time

This feature specifies the OFF time for the indicator LED while in Flash Mode. The selectable range is 100 to 9,900 milliseconds (0.1 to 9.9 seconds), in 100 millisecond increments. See [page 293](#) in “References” for detailed information on setting this feature.



Select Flash OFF Time Setting

To configure this feature, scan the ENTER/EXIT PROGRAMMING MODE bar code above, then the bar code at left followed by the digits from the Alphanumeric characters in [Appendix D, Keypad](#) representing your desired character(s). End by scanning the ENTER/EXIT bar code again.

Make a mistake? Scan the CANCEL bar code to abort and not save the entry string. You can then start again at the beginning.



CANCEL

★06 = Flash is OFF for 600ms

## Double Read Timeout

Double Read Timeout prevents a double read of the same label by setting the minimum time allowed between reads of labels of the same symbology and data. If the unit reads a label and sees the same label again within the specified timeout, the second read is ignored. Double Read Timeout does not apply to scan modes that require a trigger pull for each label read.



Double Read Timeout = 0.1 Second



Double Read Timeout = 0.2 Second



Double Read Timeout = 0.3 Second



Double Read Timeout = 0.4 Second



### Double Read Timeout (continued)



Double Read Timeout = 0.5 Second



★ Double Read Timeout = 0.6 Second



Double Read Timeout = 0.7 Second



Double Read Timeout = 0.8 Second



Double Read Timeout = 0.9 Second



Double Read Timeout = 1 Second



## Stand /Base Detection Behavior

Specifies the behavior of the reader when stationary in a stand. There are two conditions which cause the reader to switch to Stand Mode/Object Detection:

- The reader is configured to switch to Stand Mode/Object Detection when stationary.
- The reader is placed into the base station of the base station.

Below are further options concerning Stand Operation.

**Ignore Autorecognition:** Disables mode switching when the reader is placed in a stand.

**Switch to Stand Mode/Object Detection:** Automatically switches the reader to Stand Mode/Object Detection when the reader is placed in the stand.

**Switch to Always On:** Automatically switches the reader to Always On mode when the reader is placed in the stand.

**Switch to Flashing:** Automatically switches the reader to Flash Mode when the reader is placed in the stand.



Stand/Base Detection Behavior = Ignore Autorecognition  
(do not change behavior)



★ Stand/Base Detection Behavior =  
Switch to Stand Mode/Object Detection



Stand/Base Detection Behavior = Switch to Always On



Stand/Base Detection Behavior = Switch to Flashing





## Stand Mode/Object Detection Indication (Stand Mode Flash)

This operation is useful for indicating when the reader is in Stand Mode. If enabled, the blue indicator will blink when Stand Mode scanning is active.



★ Stand Mode/Object Detection Indication = Disable



Stand Mode/Object Detection Indication = Enable

## Stand Mode/Object Detection Sensitivity

Sets the sensitivity level for stand mode/object detection wakeup. Choices are low, medium and high.



Stand/Base Detection Sensitivity = Low



★ Stand/Base Detection Sensitivity = Medium



Stand/Base Detection Sensitivity = High



## Stand Mode/Object Detection Illumination Off Time

Specifies the amount of time reader illumination stays off after pulling the trigger when in Stand Mode/Object Detection. The configurable range is 01 to 32 by 01 in increments of 500ms (500ms to 16 seconds).



Set Illumination OFF Time

To configure, scan the ENTER/EXIT PROGRAMMING MODE bar code above, then the bar code at left followed by the digits from the Alphanumeric characters in [Appendix D, Keypad](#) representing your desired character(s). End by scanning the ENTER/EXIT bar code.

Make a mistake? Scan the CANCEL bar code to abort and not save the entry string. You can then start again at the beginning.



CANCEL

★04 = Illumination OFF Time 1 second

## Illumination Intensity

With the following settings the illumination intensity can be reduced if needed. Not all hardware versions support this function. Please contact Datalogic Technical Support for more information.



★Illumination Intensity and Frequency = Full Intensity



Illumination Intensity and Frequency = Reduced Intensity



## Illuminator Refresh Frequency

Illuminator refresh frequency can be increased if needed. In some conditions this can contribute to eye relaxation.



★ Illuminator Refresh Frequency = Normal Refresh Frequency



Illuminator Refresh Frequency = Increased Refresh Frequency

## Corded Stand Mode

This parameter sets the Stand Mode operation for corded models only.



★ Corded Stand Mode = Disable



Corded Stand Mode = Generic Stand



Corded Stand Mode = Permanent Stand



Corded Stand Mode = Precise Stand



## Dock Detection Beep

If enabled, when the Handheld reader is placed in a dock (base station or corded stand), it will beep.



★ Dock Detection Beep = Disable



Dock Detection Beep = Enable

## Corded Stand Beep

Enables/Disables the beep that indicates when Corded Stand position is detected.



**NOTE: This feature is available starting on firmware release 610001013**



★ Corded Stand Beep = Disable



Corded Stand Beep = Enable



## LED AND BEEPER INDICATORS

### Power On Alert

Disables or enables the indication (from the Beeper) that the reader is receiving power.



Power On Alert = Disable (No Audible Indication)



★ Power On Alert = Power-up Beep

### Good Read Beep Type

Specifies whether the good read beep has a mono or bitonal beep sound.



★ Good Read Beep Type = Mono



Good Read Beep Type = Bitonal



## Good Read Beep Frequency

Adjusts the good read beep to sound at a selectable low, medium or high frequency, selectable from the list below. (Controls the beeper's pitch/tone.)



Good Read Beep Frequency = Low



Good Read Beep Frequency = Medium



★ Good Read Beep Frequency = High



## Good Read Beep Length



Good Read Beep Length = 60 msec



★ Good Read Beep Length = 80 msec



Good Read Beep Length = 100 msec



Good Read Beep Length = 120 msec



Good Read Beep Length = 140 msec



Good Read Beep Length = 160 msec



Good Read Beep Length = 180 msec



Good Read Beep Length = 200 msec



## Good Read Beeper Volume / Vibration

Selects the beeper volume (loudness) upon a good read beep. There are three selectable volume levels.

In addition to three selectable volume levels, the user can also activate a vibration feedback for good read.



Good Read Beeper Volume = Beeper Off



Good Read Beeper Volume = Low



Good Read Beeper Volume = Medium



★ Good Read Beeper Volume = High

## Vibration Feedback for Good Read



Vibration Feedback for Good Read = Enable Vibration



★ Vibration Feedback for Good Read = Disable Vibration





## Silent Mode

If needed, audible indications can be disabled by scanning the labels below.

Please note that some important audible notifications are not muted in silent mode and other notifications are replaced by vibration or visual indications.

All changes in audible notifications are summarized here:

- Good Read beep is replaced with vibration
- Power on beep is replaced with vibration
- Connection / Disconnection / out of radio range beeps are replaced with blue LED and vibration
- Error beep, RF Error/timeout beeps, chirp beeps are replaced with red 3GL and vibration
- Battery beeps, programming labels, and RF paging beeps are not muted



Silent Mode = Enable



★ Silent Mode = Disable

## RGB Good Read Enable

Specifies whether the RGB good read indicator is enabled or disabled.



RGB Good Read = Disable



★ RGB Good Read = Enable



## RGB Good Read Color

Selects the good read LED color.



RGB Good Read Color = RED



★ RGB Good Read Color = GREEN



RGB Good Read Color = BLUE



## Good Read LED Duration

This feature specifies the amount of time that the Good Read LED remains on following a good read. The good read LED on time can be set within a range of 100 milliseconds to 25,500 milliseconds (0.1 to 25.5 seconds) in 100ms increments. A setting of 00 keeps the LED on until the next trigger pull.

See [page 294](#) in “References” for detailed instructions and examples for setting this feature.



Select Good Read LED Duration Setting

Make a mistake? Scan the CANCEL bar code to abort and not save the entry string. You can then start again at the beginning.



Good Read LED Duration Setting =  
Keep LED on until next trigger pull

To configure this feature, scan the ENTER/EXIT PROGRAMMING MODE bar code above, then the bar code at left followed by the digits from the Alphanumeric characters in [Appendix D, Keypad](#) representing your desired character(s). End by scanning the ENTER/EXIT bar code again.



CANCEL

★ 003 = Good Read LED stays on for 300 msec.



**NOTE: Indicators are dimmed during sleep.**



## Good Read: When to Indicate

This feature specifies when the reader will provide indication (beep and/or flash its green LED) upon successfully reading a bar code.



★ Indicate Good Read = After Decode



Indicate Good Read = After Transmit



Indicate Good Read =  
After CTS goes inactive then active



## Green Spot Duration

Specifies the duration of the good read pointer beam after a good read.



Green Spot Duration = Disable (Green Spot is Off)



★ Green Spot Duration = Short (300 msec)



Green Spot Duration = Medium (500 msec)



Green Spot Duration = Long (800 msec)



# CAMERA CONTROL

## Aiming Pointer

Enables/disables the aiming pointer for all symbologies.



Aiming Pointer = Disable



★ Aiming Pointer = Enable



Aiming Pointer = Green Spot

## Aiming Duration Timer

Specifies the frame of time the aiming pointer remains on after decoding a label, when in trigger single mode. The range for this setting is from 1 to 255 seconds in 1-second increments. See [page 269](#) in “References” for a description of this feature.



★ Aiming Duration Timer = Aiming Off After Decoding



Aiming Duration Timer = Set Aiming Duration Timer

To configure, scan the ENTER/EXIT PROGRAMMING MODE bar code above, then the bar code at left followed by the digits from the Alphanumeric characters in [Appendix D](#) representing your desired character(s). End by scanning the ENTER/EXIT bar code.

Make a mistake? Scan the CANCEL bar code to abort and not save the entry string. You can then start again at the beginning.



CANCEL



## Pick Mode

Specifies the ability of the reader to decode labels only when they are close to the center of the aiming pattern. This allows the reader to accurately target labels when they are placed close together, such as on a pick sheet.

The Pick Mode can be enabled only in Trigger Single Scan Mode.



**NOTE: This feature is not compatible with Multiple Labels Reading in a Volume.**



★ Pick Mode = Disable



Pick Mode = Enable

## Mobile Phone Mode

This mode is useful for scanning bar codes displayed on a mobile phone. Other options for this feature can be configured using the Datalogic Aladdin application.



Mobile Phone Mode = Disable



★ Mobile Phone Mode = Enable



Mobile Phone Mode = Enhanced



## Mobile Phone Saturation Rate

This specifies the minimum number of saturated pixels (every 1000 pixels) in the image in order to activate the Mobile Phone mode.



★ Mobile Phone Saturation Rate = 00



Mobile Phone Saturation Rate = 01



Mobile Phone Saturation Rate = 02





## Decode Negative Image

Enable/Disable the ability to decode a negative image for all symbologies. When this feature is enabled, you will be unable to read normally-printed labels or programming labels in this manual. Scan the "Disable" bar code below to return the reader to its default for this feature. To set decoding for only 2D codes, go to "2D Normal/Inverse Symbol Control" on [page 211](#). For additional options, see the Aladdin configuration application.



**NOTE:** Unlike some programming features and options, Decode Negative Image selections require that you scan only one programming bar code label. DO NOT scan an ENTER/EXIT bar code prior to scanning a Decode Negative Image bar code.



**CAUTION:** When this feature is enabled, you will be unable to read other programming labels in this manual.



★ Decode Negative Image = Disable



Decode Negative Image = Enable

## Image Capture

For information and a list of options for Image Capture, use the Datalogic Aladdin configuration application, available for free download from the Datalogic Scanning website.



## MULTIPLE LABEL READING

In standard (default) mode, when the reader’s aiming system is activated (by a trigger pull, motion or other method depending on the mode), it then acquires and processes each image in the area in front of it (the Volume). In this case, the reader stops processing the image once it decodes a label. If several labels are present in the volume, only the first label encountered is decoded and sent.

When Multiple Reading Mode is enabled, the reader keeps on processing the image until all the labels present are decoded. The reader then sorts the data from all the bar codes (if configured to do so) before transmitting it.

### Multiple Labels per Frame

Specifies the ability of the reader to decode and transmit a set of code labels in a specific volume and in a single frame of time. When in Multiple Labels per Frame the reader beeps and turns on the good read LED indication for each code read in a frame.

When Multiple Labels Mode is enabled, ISBT pairing, ABC Codabar pairing, and composites are not allowed.



★ Multiple Labels per Frame = Disable



Multiple Labels per Frame = Enable

### Multiple Labels Ordering by Code Symbology

This feature allows you to specify the order multiple labels are transmitted by symbology type, when Multiple Labels per Frame is enabled.



Select Symbologies for Multiple Labels Ordering

To configure, scan the ENTER/EXIT PROGRAMMING MODE bar code above, then the bar code at left followed by the digits from the Alphanumeric characters in [Appendix D, Keypad](#) representing your desired character(s). End by scanning the ENTER/EXIT bar code.

Make a mistake? Scan the CANCEL bar code to abort and not save the entry string. You can then start again at the beginning.



CANCEL

★ 000000000000 = Random order



## Multiple Labels Ordering by Code Length

Specifies the transmission ordering by code length, when Multiple Labels per Frame is enabled.



★ Multiple Labels Ordering = Disable



Multiple Labels Ordering = Transmit Increasing Length Order



Multiple Labels Ordering = Transmit Decreasing Length Order

# CONFIGURATION | 1D SYMBOLOGIES

## SECTION CONTENTS

### **DISABLE ALL SYMBOLOGIES** starting on page 119

- **COUPON CONTROL** starting on page 119
- **UPC-A** starting on page 120
- **UPC-E** starting on page 122
- **EAN-13** starting on page 125
- **EAN-8** starting on page 128
- **UPC/EAN GLOBAL SETTINGS** starting on page 130
- **GS1 DATABAR™ OMNIDIRECTIONAL** starting on page 134
- **GS1 DATABAR™ EXPANDED** starting on page 135
- **GS1 DATABAR™ LIMITED** starting on page 138
- **CODE 39** starting on page 139
- **TRIOPTIC CODE** starting on page 144
- **CODE 39 DANISH PPT** starting on page 144
- **CODE 39 PZN** starting on page 145
- **CODE 39 LA POSTE** starting on page 145
- **CODE 32 (ITALIAN PHARMACEUTICAL)** starting on page 146
- **CODE 39 CIP HR (FRENCH PHARMACEUTICAL)** starting on page 148
- **CODE 128** starting on page 149
- **GS1-128** starting on page 153
- **INTERLEAVED 2 OF 5 (I 2 OF 5)** starting on page 154
- **INTERLEAVED 2 OF 5, FEBRABAN (DESK MODELS ONLY)** starting on page 159
- **INTERLEAVED 2 OF 5 CIP HR** starting on page 160
- **MATRIX 2 OF 5** starting on page 161
- **STANDARD 2 OF 5** starting on page 164
- **COMPRESSED 2 OF 5** starting on page 167
- **DATALOGIC 2 OF 5** starting on page 170
- **INDUSTRIAL 2 OF 5** starting on page 173
- **IATA** starting on page 176
- **FOLLETT 2 OF 5** starting on page 177
- **CODABAR** starting on page 178
- **ABC CODABAR** starting on page 184
- **ISBT 128** starting on page 186
- **CODE 11** starting on page 189
- **CODE 93** starting on page 192
- **MSI** starting on page 196
- **PHARMACODE** starting on page 199
- **PLESSEY** starting on page 202
- **BC412** starting on page 205
-



## DISABLE ALL SYMBOLOGIES

Scan this label to disable all symbologies.



Disable All Symbolologies

## COUPON CONTROL

### Coupon Control

This feature is used to control the method of processing coupon labels.

Options are:

- Allow all — allow all coupon bar codes to be decoded
- Enable only UPC/EAN — enables only UPC/EAN coupon decoding
- Enable only GS1 DataBar — enables only GS1 DataBar coupon decoding

To set this feature:

1. Scan the Enter/Exit bar code.
2. Scan either the enable or disable bar code below. You'll need to cover any unused bar codes on this and the facing page to ensure that the reader sees only the bar code you intend to scan.
3. Complete the programming sequence by scanning the Enter/Exit bar code.



Coupon Control = Allow all



★ Coupon Control = Enable only UPC/EAN



Coupon Control = Enable only GS1 DataBar



## UPC-A

The following options apply to the UPC-A symbology.

### UPC-A Enable/Disable

When disabled, the reader will not read UPC-A bar codes.



UPC-A = Disable



★UPC-A = Enable

### UPC-A Check Character Transmission

Enable this option to transmit the check character along with UPC-A bar code data.



UPC-A Check Character Transmission = Don't Send



★UPC-A Check Character Transmission = Send



## Expand UPC-A to EAN-13

Expands UPC-A data to the EAN-13 data format. Selecting this feature also changes the symbology ID to match those required for EAN-13.



★ UPC-A to EAN-13 = Don't Expand



UPC-A to EAN-13 = Expand

## UPC-A Number System Character Transmission

This feature enables/disables transmission of the UPC-A number system character.



UPC-A Number System Character = Do not transmit



★ UPC-A Number System Character = Transmit



## UPC-E

The following options apply to the UPC-E symbology.

### UPC-E Enable/Disable

When disabled, the reader will not read UPC-E bar codes.



UPC-E = Disable



★UPC-E = Enable

### UPC-E Check Character Transmission

Enable this option to transmit the check character along with UPC-E bar code data.



UPC-E Check Character Transmission = Don't Send



★UPC-E Check Character Transmission = Send





## Expand UPC-E to EAN-13

Expands UPC-E data to the EAN-13 data format. Selecting this feature also changes the symbology ID to match those required for EAN-13.



★ UPC-E to EAN-13 = Don't Expand



UPC-E to EAN-13 = Expand

## Expand UPC-E to UPC-A

Expands UPC-E data to the UPC-A data format. Selecting this feature also changes the symbology ID to match those required for UPC-A.



★ UPC-E to UPC-A = Don't Expand



UPC-E to UPC-A = Expand

## UPC-E Number System Character Transmission

This feature enables/disables transmission of the UPC-E number system character.



UPC-E Number System Character = Do not transmit



★ UPC-E Number System Character = Transmit



## GTIN Formatting

This feature enables/disables the ability to convert UPC-E, UPC-A, EAN-8, and EAN-13 labels into the GTIN 14-character format.



★ GTIN Formatting = Disable



GTIN Formatting = Enable



## EAN-13

The following options apply to the EAN-13 symbology.

### EAN-13 Enable/Disable

When disabled, the reader will not read EAN-13 bar codes.



EAN-13 = Disable



★ EAN-13 = Enable

### EAN-13 Check Character Transmission

Enable this option to transmit the check character along with EAN-13 bar code data.



EAN-13 Check Character Transmission = Don't Send



★ EAN-13 Check Character Transmission = Send



## EAN-13 Flag 1 Character

Enables/disables transmission of an EAN/JAN-13 Flag1 character. The Flag 1 character is the first character of the label



EAN-13 Flag 1 Char = Don't transmit



★ EAN-13 Flag 1 Char = Transmit

## EAN-13 to ISBN Conversion

This option enables/disables conversion of EAN-13/JAN-13 Bookland labels starting with 978 to ISBN labels.



★ EAN-13 ISBN Conversion = Disable



EAN-13 ISBN Conversion = Enable



## EAN-13 to ISSN Conversion

Enables/disables conversion of EAN/JAN-13 Bookland labels starting with 977 to ISSN labels.



★ ISSN = Disable



ISSN = Enable



## EAN-8

The following options apply to the EAN-8 symbology.

### EAN-8 Enable/Disable

When disabled, the reader will not read EAN-8 bar codes.



EAN-8 = Disable



★ EAN-8 = Enable

### EAN-8 Check Character Transmission

Enable this option to transmit the check character along with EAN-8 bar code data.



EAN-8 Check Character Transmission = Don't Send



★ EAN-8 Check Character Transmission = Send



## Expand EAN-8 to EAN-13

Enable this option to expand EAN-8/JAN-8 labels to EAN-13/JAN-13.



★ EAN-8 to EAN-13 = Don't Expand



EAN-8 to EAN-13 = Expand



## UPC/EAN GLOBAL SETTINGS

This section provides configuration settings for UPC-A, UPC-E, EAN 13 and EAN 8 symbologies, and affects all of these unless otherwise marked for each feature description.

### UPC/EAN Price Weight Check

This feature enables/disables calculation and verification of price/weight check digits.

Options are

- Disabled
- Enable 4-digit price-weight check-digit calculation
- Enable 5-digit price-weight check-digit calculation
- Enable European 4-digit price-weight check-digit calculation
- Enable European 5-digit price-weight check-digit calculation



★ Price Weight Check = Disable



Price Weight Check = 4-digit price-weight check



Price Weight Check = 5-digit price-weight check



Price Weight Check = European 4-digit price-weight check



Price Weight Check = European 5-digit price-weight check





## UPC/EAN Quiet Zones

This feature specifies the number of quiet zones for UPC/EAN labels. Quiet zones are blank areas at the ends of a bar code, typically 10 times the width of the narrowest bar or space in the label. The property applies to all EAN-UPC symbologies globally and to the ADD-ONS.



★ UPC/EAN Quiet Zones = Two Modules



UPC/EAN Quiet Zones = Three Modules

## Add-Ons

The following features apply to optional add-ons.



**NOTE: Contact Customer Support for advanced programming of optional and conditional add-ons.**



## Optional Add-ons

The reader can be enabled to optionally read the following add-ons (supplementals):

- P2
- P5



**NOTE: If a UPC/EAN base label and a an add-on are both decoded, the reader will transmit the base label and add-on. If a UPC/EAN base label is decoded without an add-on, the base label will be transmitted without an add-on.**

**Conditional add-on settings (if enabled) are considered by the reader before optional add-on settings.**



★ Optional Add-Ons = Disable P2



Optional Add-Ons = Enable P2



★ Optional Add-Ons = Disable P5



Optional Add-Ons = Enable P5



## Optional Add-On Timer

This option sets the time the reader will look for an add-on when an add-on fragment has been seen and optional add-ons are enabled.



Optional Add-on Timer = 10ms



Optional Add-on Timer = 20ms



Optional Add-on Timer = 30ms



Optional Add-on Timer = 50ms



★ Optional Add-on Timer = 70ms



Optional Add-on Timer = 100ms



Optional Add-on Timer = 160ms



## GS1 DATABAR™ OMNIDIRECTIONAL

The following options apply to the GS1 DataBar Omnidirectional (formerly RSS-14) symbology.

### GS1 DataBar Omnidirectional Enable/Disable

When disabled, the reader will not read GS1 DataBar Omnidirectional bar codes.



★ GS1 DataBar Omnidirectional = Disable



GS1 DataBar Omnidirectional = Enable

### GS1 DataBar Omnidirectional to GS1-128 Emulation

When enabled, GS1 DataBar Omnidirectional bar codes will be translated to the GS1-128 label data format.



★ GS1 DataBar Omnidirectional to GS1-128 Emulation = Disable



GS1 DataBar Omnidirectional to GS1-128 Emulation = Enable



## GS1 DATABAR™ EXPANDED

The following options apply to the GS1 DataBar Expanded (formerly RSS Expanded) symbology.

### GS1 DataBar Expanded Enable/Disable

When disabled, the reader will not read GS1 DataBar Expanded bar codes.



★ GS1 DataBar Expanded = Disable



GS1 DataBar Expanded = Enable

### GS1 DataBar Expanded to GS1-128 Emulation

When enabled, GS1 DataBar Expanded bar codes will be translated to the GS1-128 label data format.



★ GS1 DataBar Expanded to GS1-128 Emulation  
= Disable



GS1 DataBar Expanded to GS1-128 Emulation  
= Enable



## GS1 DataBar Expanded Length Control

This feature specifies either variable length decoding or fixed length decoding for the GS1 DataBar Expanded symbology.

**Variable Length:** For variable-length decoding, a minimum length may be set.

**Fixed Length:** For fixed-length decoding, two different lengths may be set.



★ GS1 DataBar Expanded Length Control  
= Variable Length



GS1 DataBar Expanded Length Control = Fixed Length

## GS1 DataBar Expanded Set Length 1

This feature specifies one of the bar code lengths for "GS1 DataBar Expanded Length Control" on page 136. Length 1 is the minimum label length if in Variable Length Mode, or the first fixed length if in Fixed Length Mode. Length includes the bar code's data characters only.

The length can be set from 1 to 74 characters. See "Set Length 1" on page 297 for more detailed programming instructions.



Select GS1 DataBar Expanded Set Length 1 Setting

To configure this feature, scan the ENTER/EXIT PROGRAMMING MODE bar code above, then the bar code at left followed by the digits from the Alphanumeric characters in Appendix D, Keypad representing your desired character(s). End by scanning the ENTER/EXIT bar code again.

Make a mistake? Scan the CANCEL bar code to abort and not save the entry string. You can then start again at the beginning.



CANCEL

★ Length 1 = 01 (one character)



## GS1 DataBar Expanded Set Length 2

This feature specifies one of the bar code lengths for "GS1 DataBar Expanded Length Control" on page 136. Length 2 is the maximum label length if in Variable Length Mode, or the second fixed length if in Fixed Length Mode. Length includes the bar code's data characters only.

The length can be set from 1 to 74 characters. A setting of 00 specifies to ignore this length (only one fixed length). See "Set Length 2" on page 298 for more detailed programming instructions.



Select GS1 DataBar Expanded Set Length 2 Setting

To configure this feature, scan the ENTER/EXIT PROGRAMMING MODE bar code above, then the bar code at left followed by the digits from the Alphanumeric characters in [Appendix D, Keypad](#) representing your desired character(s). End by scanning the ENTER/EXIT bar code again.

Make a mistake? Scan the CANCEL bar code to abort and not save the entry string. You can then start again at the beginning.



CANCEL

★ Length 2 = 74 (74 characters)



## GS1 DATABAR™ LIMITED

The following options apply to the GS1 DataBar Limited (formerly RSS Limited) symbology.

### GS1 DataBar Limited Enable/Disable

When disabled, the reader will not read GS1 DataBar Limited bar codes.



★ GS1 DataBar Limited = Disable



GS1 DataBar Limited = Enable

### GS1 DataBar Limited to GS1-128 Emulation

When enabled, GS1 DataBar Limited bar codes will be translated to the GS1-128 label data format.



★ GS1 DataBar Limited to GS1-128 Emulation = Disable



GS1 DataBar Limited to GS1-128 Emulation = Enable





## CODE 39

The following options apply to the Code 39 symbology.

### Code 39 Enable/Disable

When disabled, the reader will not read Code 39 bar codes.



Code 39 = Disable



★ Code 39 = Enable

### Code 39 Check Character Calculation

Enable this option to enable/disable calculation and verification of an optional Code 39 check character. When disabled, any check character in the label is treated as a data character.



★ Code 39 Check Character Calculation = Don't Calculate



Code 39 Check Character Calculation = Calculate Std Check



Code 39 Check Character Calculation = Calculate Mod 7 Check



Code 39 Check Character Calculation = Enable Italian Post Check



Code 39 Check Character Calculation = Enable Daimler Chrysler Check

## Code 39 Check Character Transmission

Enable this option to transmit the check character along with Code 39 bar code data.



Code 39 Check Character Transmission = Don't Send



★ Code 39 Check Character Transmission = Send

## Code 39 Start/Stop Character Transmission

Enable this option to enable/disable transmission of Code 39 start and stop characters.



★ Code 39 Start/Stop Character Transmission = Don't Transmit



Code 39 Start/Stop Character Transmission = Transmit



## Code 39 Full ASCII

In Code 39 decoding, this enables/disables the translation of Code 39 characters to Code 39 full-ASCII characters.



★ Code 39 Full ASCII = Disable



Code 39 Full ASCII = Enable

## Code 39 Quiet Zones

This feature specifies the number of quiet zones for Code 39 labels. Quiet zones are blank areas at the ends of a bar code and are typically 10 times the width of the narrowest bar or space in the label.



Code 39 Quiet Zones = Quiet Zone on one side



Code 39 Quiet Zones = Quiet Zones on two sides



Code 39 Quiet Zones = Auto



Code 39 Quiet Zones = Virtual Quiet Zones on two sides



★ Code 39 Quiet Zones =  
Small Quiet Zones on two sides



## Code 39 Length Control

This feature specifies either variable length decoding or fixed length decoding for the Code 39 symbology.

**Variable Length:** For variable-length decoding, a minimum length may be set.

**Fixed Length:** For fixed-length decoding, two different lengths may be set.



★ Code 39 Length Control  
= Variable Length



Code 39 Length Control = Fixed Length

## Code 39 Set Length 1

This feature specifies one of the bar code lengths for "Code 39 Length Control" on page 142. Length 1 is the minimum label length if in Variable Length Mode, or the first fixed length if in Fixed Length Mode. Length includes the bar code's check, data, and full-ASCII shift characters. The length does not include start/stop characters.

The length can be set from 0 to 50 characters. See "Set Length 1" on page 297 for more detailed programming instructions.



Select Code 39 Set Length 1 Setting

To configure this feature, scan the ENTER/EXIT PROGRAMMING MODE bar code above, then the bar code at left followed by the digits from the Alphanumeric characters in Appendix D, Keypad representing your desired character(s). End by scanning the ENTER/EXIT bar code again.

Make a mistake? Scan the CANCEL bar code to abort and not save the entry string. You can then start again at the beginning.



CANCEL

★ Length 1 = 02 (2 characters)



## Code 39 Set Length 2

This feature specifies one of the bar code lengths for "Code 39 Length Control" on page 142. Length 2 is the maximum label length if in Variable Length Mode, or the second fixed length if in Fixed Length Mode. Length includes the bar code's check, data, and full-ASCII shift characters. The length does not include start/stop characters.

The length can be set from 1 to 50 characters. A setting of 00 specifies to ignore this length (only one fixed length). See "Set Length 2" on page 298 for more detailed programming instructions.



Select Code 39 Set Length 2 Setting

To configure this feature, scan the ENTER/EXIT PROGRAMMING MODE bar code above, then the bar code at left followed by the digits from the Alphanumeric characters in [Appendix D, Keypad](#) representing your desired character(s). End by scanning the ENTER/EXIT bar code again.

Make a mistake? Scan the CANCEL bar code to abort and not save the entry string. You can then start again at the beginning.



CANCEL

★ Length 2 = 50 (50 characters)



## TRIOPTIC CODE

The following options apply to the trioptic symbology.

### Trioptic Code Enable/Disable

When disabled, the reader will not read Trioptic Code bar codes.



★ Trioptic Code = Disable



Trioptic Code = Enable

## CODE 39 DANISH PPT

The following options apply to the Code 39 Danish PPT symbology.

### Code 39 Danish PPT Enable/Disable

When disabled, the reader will not read Code 39 Danish PPT bar codes.



★ Code 39 Danish PPT = Disable



Code 39 Danish PPT = Enable



## CODE 39 PZN

The following options apply to the Code 39 PZN symbology.

### Code 39 PZN Enable/Disable

When disabled, the reader will not read Code 39 PZN bar codes.



★ Code 39 PZN = Disable



Code 39 PZN = Enable

## CODE 39 LA POSTE

The following options apply to the Code 39 La Poste symbology.

### Code 39 La Poste Enable/Disable

When disabled, the reader will not read Code 39 La Poste bar codes.



★ Code 39 La Poste = Disable



Code 39 La Poste = Enable



## CODE 32 (ITALIAN PHARMACEUTICAL)

The following options apply to the Code 32 symbology.

### Code 32 Enable/Disable

When disabled, the reader will not read Code 32 bar codes.



★ Code 32 = Disable



Code 32 = Enable

### Code 32 Feature Setting Exceptions



**NOTE: The following features are set for Code 32 by using these Code 39 settings:**

"Code 39 Quiet Zones" on page 141

"Code 39 Length Control" on page 142

### Code 32 Check Character Transmission

Enable this option to transmit the check character along with Code 32 bar code data.



★ Code 32 Check Character Transmission = Don't Send



Code 32 Check Character Transmission = Send





## Code 32 Start/Stop Character Transmission

Enable this option to enable/disable transmission of Code 32 start and stop characters.



★ Code 32 Start/Stop Character Transmission  
= Don't Transmit



Code 32 Start/Stop Character Transmission  
= Transmit



## CODE 39 CIP HR (FRENCH PHARMACEUTICAL)

The following options apply to the Code 39 CIP HR symbology.

### Code 39 CIP HR Enable/Disable

Enables/Disables ability of the reader to decode Code 39 CIP HR labels.



★ Code 39 CIP HR = Disable



Code 39 CIP HR = Enable



## CODE 128

The following options apply to the Code 128 symbology.

### Code 128 Enable/Disable

Enables/Disables ability of the reader to decode Code 128 labels.



Code 128 = Disable



★ Code 128 = Enable

### Expand Code 128 to Code 39

This feature enables/disables expansion of Code 128 labels to Code 39 labels. When enabled, the label identifier for a Code 128 label shall be set to Code 39 and all Code 39 formatting control shall be applied to the label.



★ Code 128 to Code 39 = Don't Expand



Code 128 to Code 39 = Expand



## Code 128 Check Character Transmission

Enable this option to transmit the check character along with Code 128 bar code data.



★ Code 128 Check Character Transmission =  
Don't Send



Code 128 Check Character Transmission = Send

## Code 128 Function Character Transmission

Enables/disables transmission of Code128 function characters 1, 2, 3, and 4.



★ Code 128 Function Character Transmission =  
Don't Send



Code 128 Function Character Transmission = Send



## Code 128 Quiet Zones

This feature specifies the number of quiet zones for Code 128 labels. Quiet zones are blank areas at the ends of a bar code and are typically 10 times the width of the narrowest bar or space in the label.



Code 128 Quiet Zones = No Quiet Zones



Code 128 Quiet Zones = Quiet Zone on one side



Code 128 Quiet Zones = Quiet Zones on two sides



★ Code 128 Quiet Zones = Auto



Code 128 Quiet Zones = Virtual Quiet Zones on two sides

## Code 128 Length Control

This feature specifies either variable length decoding or fixed length decoding for the Code 128 symbology.

**Variable Length:** For variable-length decoding, a minimum length may be set.

**Fixed Length:** For fixed-length decoding, two different lengths may be set.



★ Code 128 Length Control = Variable Length



Code 128 Length Control = Fixed Length



## Code 128 Set Length 1

This feature specifies one of the bar code lengths for "[Code 128 Length Control](#)" on page 151. Length 1 is the minimum label length if in Variable Length Mode, or the first fixed length if in Fixed Length Mode. Length includes the bar code's data characters only.

The length can be set from 1 to 80 characters. See "[Set Length 1](#)" on page 297 for more detailed programming instructions.



Select Code 128 Set Length 1 Setting

To configure this feature, scan the ENTER/EXIT PROGRAMMING MODE bar code above, then the bar code at left followed by the digits from the Alphanumeric characters in [Appendix D, Keypad](#) representing your desired character(s). End by scanning the ENTER/EXIT bar code again.

Make a mistake? Scan the CANCEL bar code to abort and not save the entry string. You can then start again at the beginning.



CANCEL

★ Length 1 = 01 (one character)

## Code 128 Set Length 2

This feature specifies one of the bar code lengths for "[Code 128 Length Control](#)" on page 151. Length 2 is the maximum label length if in Variable Length Mode, or the second fixed length if in Fixed Length Mode. Length includes the bar code's data characters only.

The length can be set from 1 to 80 characters. A setting of 00 specifies to ignore this length (only one fixed length). See "[Set Length 2](#)" on page 298 for more detailed programming instructions.



Select Code 128 Set Length 2 Setting

To configure this feature, scan the ENTER/EXIT PROGRAMMING MODE bar code above, then the bar code at left followed by the digits from the Alphanumeric characters in [Appendix D, Keypad](#) representing your desired character(s). End by scanning the ENTER/EXIT bar code again.

Make a mistake? Scan the CANCEL bar code to abort and not save the entry string. You can then start again at the beginning.



CANCEL

★ Length 2 = 80 (80 characters)



## GS1-128

The following options apply to the GS1-128 symbology. (Also known as USS-128, GTIN-128, UCC-128.)

### GS1-128 Enable

This option enables/disables the ability of the reader to translate GS1-128 labels to the GS1-128 data format. Options are:

- Transmit GS1-128 labels in Code 128 data format.
- Transmit GS1-128 labels in GS1-128 data format.
- Do not transmit GS1-128 labels.



GS1-128 = Transmit in Code 128 data format



★ GS1-128 = Transmit in GS1-128 data format



GS1-128 = Do not transmit GS1-128 labels



## INTERLEAVED 2 OF 5 (I 2 OF 5)

The following options apply to the I 2 of 5 symbology.



**CAUTION: When reading this symbology, the settings for I 2 of 5 Length Control AND I 2 of 5 Check Character Calculation MUST be enabled to increase decoding safety.**

### I 2 of 5 Enable/Disable

When disabled, the reader will not read I 2 of 5 bar codes.



★ I 2 of 5 = Disable



I 2 of 5 = Enable





## I 2 of 5 Check Character Calculation

This option enables/disables calculation and verification of an optional I 2 of 5 check character.



★ I 2 of 5 Check Character Calculation = Disable



I 2 of 5 Check Character Calculation  
= Calculate Std Check (Modulo 10 no AR)



I 2 of 5 Check Character Calculation  
= Calculate German Parcel Check



I 2 of 5 Check Character Calculation  
= Calculate DHL Check



I 2 of 5 Check Character Calculation  
= Calculate Daimler Chrysler Check



## I 2 of 5 Check Character Calculation (continued)



I 2 of 5 Check Character Calculation  
= Calculate Bosch Check



I 2 of 5 Check Character Calculation  
= Calculate Italian Post Check

## I 2 of 5 Check Character Transmission

Enable this option to transmit the check character along with I 2 of 5 bar code data.



**NOTE: This feature is valid only when I 2 of 5 Check Character Calculation is enabled.**



I 2 of 5 Check Character Transmission = Don't Send



★ I 2 of 5 Check Character Transmission = Send



## I 2 of 5 Length Control

This feature specifies either variable length decoding or fixed length decoding for the I 2 of 5 symbology.

**Variable Length:** For variable-length decoding, a minimum length may be set.

**Fixed Length:** For fixed-length decoding, two different lengths may be set.



★ I 2 of 5 Length Control = Variable Length



I 2 of 5 Length Control = Fixed Length

## I 2 of 5 Set Length 1

This feature specifies one of the bar code lengths for "I 2 of 5 Length Control" on page 157. Length 1 is the minimum label length if in Variable Length Mode, or the first fixed length if in Fixed Length Mode. The length includes the bar code's check and data characters. The length can be set from 2 to 50 characters in increments of two. See "Set Length 1" on page 297 for more detailed programming instructions.



Select I 2 of 5 Set Length 1 Setting

To configure this feature, scan the ENTER/EXIT PROGRAMMING MODE bar code above, then the bar code at left followed by the digits from the Alphanumeric characters in [Appendix D, Keypad](#) representing your desired character(s). End by scanning the ENTER/EXIT bar code again.

Make a mistake? Scan the CANCEL bar code to abort and not save the entry string. You can then start again at the beginning.



CANCEL

★ Length 1 = 06 (6 characters)



## I 2 of 5 Set Length 2

This feature specifies one of the bar code lengths for "I 2 of 5 Length Control" on page 157. Length 2 is the maximum label length if in Variable Length Mode, or the second fixed length if in Fixed Length Mode. The length includes the bar code's check and data characters. The length can be set from 2 to 50 characters in increments of two. A setting of 00 specifies to ignore this length (only one fixed length). See "Set Length 2" on page 298 for more detailed programming instructions.



Select I 2 of 5 Set Length 2 Setting

To configure this feature, scan the ENTER/EXIT PROGRAMMING MODE bar code above, then the bar code at left followed by the digits from the Alphanumeric characters in [Appendix D, Keypad](#) representing your desired character(s). End by scanning the ENTER/EXIT bar code again.

Make a mistake? Scan the CANCEL bar code to abort and not save the entry string. You can then start again at the beginning.



CANCEL

★ Length 2 = 50 (50 characters)



## INTERLEAVED 2 OF 5, FEBRABAN (DESK MODELS ONLY)

### Interleaved 2 of 5, Febraban format Enable / Disable



**NOTE: Interleaved 2 of 5 shall be enabled before enabling Febraban variant.**

Enables/Disables ability of reader to decode Interleaved 2 of 5, Febraban format.



★ 2 of 5, Febraban format = Disable



2 of 5, Febraban format = Enable



## INTERLEAVED 2 OF 5 CIP HR

The following options apply to the Interleaved 2 of 5 CIP HR symbology.

### Interleaved 2 of 5 CIP HR Enable/Disable

Enables/Disables ability of the reader to decode Interleaved 2 of 5 CIP HR labels.



★ Interleaved 2 of 5 CIP HR = Disable



Interleaved 2 of 5 CIP HR = Enable



## MATRIX 2 OF 5

The following options apply to the Matrix 2 of 5 symbology.

### Matrix 2 of 5 Enable/Disable

When disabled, the reader will not read Matrix 2 of 5 bar codes.



★ Matrix 2 of 5 = Disable



Matrix 2 of 5 = Enable

### Matrix 2 of 5 Check Character Calculation

This option enables/disables calculation and verification of an optional Matrix 2 of 5 check character.



★ Matrix 2 of 5 Check Character Calculation  
= Disable



Matrix 2 of 5 Check Character Calculation = Enable



## Matrix 2 of 5 Check Character Transmission

This feature enables/disables transmission of an optional Matrix 2 of 5 check character.



Matrix 2 of 5 Check Character Transmission  
= Don't Send



★ Matrix 2 of 5 Check Character Transmission  
= Send

## Matrix 2 of 5 Length Control

This feature specifies either variable length decoding or fixed length decoding for the Matrix 2 of 5 symbology.

**Variable Length:** For variable-length decoding, a minimum length may be set.

**Fixed Length:** For fixed-length decoding, two different lengths may be set.



★ Matrix 2 of 5 Length Control = Variable Length



Matrix 2 of 5 Length Control = Fixed Length





## Matrix 2 of 5 Set Length 1

This feature specifies one of the bar code lengths for "[Standard 2 of 5 Length Control](#)" on [page 165](#). Length 1 is the minimum label length if in Variable Length Mode, or the first fixed length if in Fixed Length Mode. The length includes the bar code's check and data characters.

The length can be set from 1 to 50 characters. See "[Set Length 1](#)" on [page 297](#) for more detailed programming instructions.



Select Matrix 2 of 5 Length 1 Setting

To configure this feature, scan the ENTER/EXIT PROGRAMMING MODE bar code above, then the bar code at left followed by the digits from the Alphanumeric characters in [Appendix D, Keypad](#) representing your desired character(s). End by scanning the ENTER/EXIT bar code again.

Make a mistake? Scan the CANCEL bar code to abort and not save the entry string. You can then start again at the beginning.



CANCEL

★ Length 1 = 08 (8 characters)

## Matrix 2 of 5 Set Length 2

This feature specifies one of the bar code lengths for "[Standard 2 of 5 Length Control](#)" on [page 165](#). Length 2 is the maximum label length if in Variable Length Mode, or the second fixed length if in Fixed Length Mode. The length includes the bar code's check and data characters.

The length can be set from 1 to 50 characters. A setting of 00 specifies to ignore this length (only one fixed length). See "[Set Length 2](#)" on [page 298](#) for more detailed programming instructions.



Select Matrix 2 of 5 Set Length 2 Setting

To configure this feature, scan the ENTER/EXIT PROGRAMMING MODE bar code above, then the bar code at left followed by the digits from the Alphanumeric characters in [Appendix D, Keypad](#) representing your desired character(s). End by scanning the ENTER/EXIT bar code again.

Make a mistake? Scan the CANCEL bar code to abort and not save the entry string. You can then start again at the beginning.



CANCEL

★ Length 2 = 50 (50 characters)



## STANDARD 2 OF 5

The following options apply to the Standard 2 of 5 symbology.

### Standard 2 of 5 Enable/Disable

When disabled, the reader will not read Standard 2 of 5 bar codes.



★ Standard 2 of 5 = Disable



Standard 2 of 5 = Enable

### Standard 2 of 5 Check Character Calculation

This option enables/disables calculation and verification of an optional Standard 2 of 5 check character.



★ Standard 2 of 5 Check Character Calculation  
= Disable



Standard 2 of 5 Check Character Calculation = Enable



## Standard 2 of 5 Check Character Transmission

This feature enables/disables transmission of an optional Standard 2 of 5 check character.



Standard 2 of 5 Check Character Transmission  
= Don't Send



★ Standard 2 of 5 Check Character Transmission  
= Send

## Standard 2 of 5 Length Control

This feature specifies either variable length decoding or fixed length decoding for the Standard 2 of 5 symbology.

**Variable Length:** For variable-length decoding, a minimum length may be set.

**Fixed Length:** For fixed-length decoding, two different lengths may be set.



★ Standard 2 of 5 Length Control = Variable Length



Standard 2 of 5 Length Control = Fixed Length



## Standard 2 of 5 Set Length 1

This feature specifies one of the bar code lengths for "Standard 2 of 5 Length Control" on [page 165](#). Length 1 is the minimum label length if in Variable Length Mode, or the first fixed length if in Fixed Length Mode. The length includes the bar code's check and data characters.

The length can be set from 1 to 50 characters. See "Set Length 1" on [page 297](#) for more detailed programming instructions.



Select Standard 2 of 5 Length 1 Setting

To configure this feature, scan the ENTER/EXIT PROGRAMMING MODE bar code above, then the bar code at left followed by the digits from the Alphanumeric characters in [Appendix D, Keypad](#) representing your desired character(s). End by scanning the ENTER/EXIT bar code again.

Make a mistake? Scan the CANCEL bar code to abort and not save the entry string. You can then start again at the beginning.



CANCEL

★ Length 1 = 08 (8 characters)

## Standard 2 of 5 Set Length 2

This feature specifies one of the bar code lengths for "Standard 2 of 5 Length Control" on [page 165](#). Length 2 is the maximum label length if in Variable Length Mode, or the second fixed length if in Fixed Length Mode. The length includes the bar code's check and data characters.

The length can be set from 1 to 50 characters. A setting of 00 specifies to ignore this length (only one fixed length). See "Set Length 2" on [page 298](#) for more detailed programming instructions.



Select Standard 2 of 5 Set Length 2 Setting

To configure this feature, scan the ENTER/EXIT PROGRAMMING MODE bar code above, then the bar code at left followed by the digits from the Alphanumeric characters in [Appendix D, Keypad](#) representing your desired character(s). End by scanning the ENTER/EXIT bar code again.

Make a mistake? Scan the CANCEL bar code to abort and not save the entry string. You can then start again at the beginning.



CANCEL

★ Length 2 = 50 (50 characters)



## COMPRESSED 2 OF 5

The following options apply to the Compressed 2 of 5 symbology.

### Compressed 2 of 5 Enable/Disable

When disabled, the reader will not read Compressed 2 of 5 bar codes.



★ Compressed 2 of 5 = Disable



Compressed 2 of 5 = Enable

### Compressed 2 of 5 Check Character Calculation

This option enables/disables calculation and verification of an optional Compressed 2 of 5 check character.



★ Compressed 2 of 5 Check Character Calculation  
= Disable



Compressed 2 of 5 Check Character Calculation = Enable



## Compressed 2 of 5 Check Character Transmission

This feature enables/disables transmission of an optional Compressed 2 of 5 check character.



Compressed 2 of 5 Check Character Transmission  
= Don't Send



★ Compressed 2 of 5 Check Character Transmission  
= Send

## Compressed 2 of 5 Length Control

This feature specifies either variable length decoding or fixed length decoding for the Compressed 2 of 5 symbology.

**Variable Length:** For variable-length decoding, a minimum length may be set.

**Fixed Length:** For fixed-length decoding, two different lengths may be set.



★ Compressed 2 of 5 Length Control = Variable  
Length



Compressed 2 of 5 Length Control = Fixed Length



## Compressed 2 of 5 Set Length 1

This feature specifies one of the bar code lengths for "[Compressed 2 of 5 Length Control](#)" on page 168. Length 1 is the minimum label length if in Variable Length Mode, or the first fixed length if in Fixed Length Mode. The length includes the bar code's check and data characters.

The length can be set from 1 to 50 characters. See "[Set Length 1](#)" on page 297 for more detailed programming instructions.



Select Compressed 2 of 5 Length 1 Setting

To configure this feature, scan the ENTER/EXIT PROGRAMMING MODE bar code above, then the bar code at left followed by the digits from the Alphanumeric characters in [Appendix D, Keypad](#) representing your desired character(s). End by scanning the ENTER/EXIT bar code again.

Make a mistake? Scan the CANCEL bar code to abort and not save the entry string. You can then start again at the beginning.



CANCEL

★ Length 1 = 01 (one character)

## Compressed 2 of 5 Set Length 2

This feature specifies one of the bar code lengths for "[Compressed 2 of 5 Length Control](#)" on page 168. Length 2 is the maximum label length if in Variable Length Mode, or the second fixed length if in Fixed Length Mode. The length includes the bar code's check and data characters.

The length can be set from 1 to 50 characters. A setting of 00 specifies to ignore this length (only one fixed length). See "[Set Length 2](#)" on page 298 for more detailed programming instructions.



Select Compressed 2 of 5 Set Length 2 Setting

To configure this feature, scan the ENTER/EXIT PROGRAMMING MODE bar code above, then the bar code at left followed by the digits from the Alphanumeric characters in [Appendix D, Keypad](#) representing your desired character(s). End by scanning the ENTER/EXIT bar code again.

Make a mistake? Scan the CANCEL bar code to abort and not save the entry string. You can then start again at the beginning.



CANCEL

★ Length 2 = 50 (50 characters)



## DATALOGIC 2 OF 5

The following options apply to the Datalogic 2 of 5 symbology.

### Datalogic 2 of 5 Enable/Disable

When disabled, the reader will not read Datalogic 2 of 5 bar codes.



★ Datalogic 2 of 5 = Disable



Datalogic 2 of 5 = Enable

### Datalogic 2 of 5 Check Character Calculation

This option enables/disables calculation and verification of an optional Datalogic 2 of 5 check character.



★ Datalogic 2 of 5 Check Character Calculation  
= Disable



Datalogic 2 of 5 Check Character Calculation = Enable





## Datalogic 2 of 5 Check Character Transmission

Enable this option to transmit the check character along with Datalogic 2 of 5 bar code data.



Datalogic 2 of 5 Check Character Transmission  
= Don't Send



★ Datalogic 2 of 5 Check Character Transmission  
= Send

## Datalogic 2 of 5 Length Control

This feature specifies either variable length decoding or fixed length decoding for the Datalogic 2 of 5 symbology.

**Variable Length:** For variable-length decoding, a minimum length may be set.

**Fixed Length:** For fixed-length decoding, two different lengths may be set.



★ Datalogic 2 of 5 Length Control = Variable Length



Datalogic 2 of 5 Length Control = Fixed Length



## Datalogic 2 of 5 Set Length 1

This feature specifies one of the bar code lengths for "Datalogic 2 of 5 Length Control" on [page 171](#). Length 1 is the minimum label length if in Variable Length Mode, or the first fixed length if in Fixed Length Mode. The length includes the bar code's check and data characters. The length can be set from 2 to 50 characters in increments of two. See "Set Length 1" on [page 297](#) for more detailed programming instructions.



Select Datalogic 2 of 5 Length 1 Setting

To configure this feature, scan the ENTER/EXIT PROGRAMMING MODE bar code above, then the bar code at left followed by the digits from the Alphanumeric characters in [Appendix D, Keypad](#) representing your desired character(s). End by scanning the ENTER/EXIT bar code again.

Make a mistake? Scan the CANCEL bar code to abort and not save the entry string. You can then start again at the beginning.



CANCEL

★ Length 1 = 06 (6 characters)

## Datalogic 2 of 5 Set Length 2

This feature specifies one of the bar code lengths for "Datalogic 2 of 5 Length Control" on [page 171](#). Length 2 is the maximum label length if in Variable Length Mode, or the second fixed length if in Fixed Length Mode. The length includes the bar code's check and data characters. The length can be set from 2 to 50 characters. A setting of 00 specifies to ignore this length (only one fixed length). See "Set Length 2" on [page 298](#) for more detailed programming instructions.



Select Datalogic 2 of 5 Set Length 2 Setting

To configure this feature, scan the ENTER/EXIT PROGRAMMING MODE bar code above, then the bar code at left followed by the digits from the Alphanumeric characters in [Appendix D, Keypad](#) representing your desired character(s). End by scanning the ENTER/EXIT bar code again.

Make a mistake? Scan the CANCEL bar code to abort and not save the entry string. You can then start again at the beginning.



CANCEL

★ Length 2 = 50 (50 characters)



## INDUSTRIAL 2 OF 5

The following options apply to the Industrial 2 of 5 symbology.

### Industrial 2 of 5 Enable/Disable

When disabled, the reader will not read Industrial 2 of 5 bar codes.



★ Industrial 2 of 5 = Disable



Industrial 2 of 5 = Enable

### Industrial 2 of 5 Check Character Calculation

Enables/Disables calculation and verification of an optional Industrial 2 of 5 check character.



★ Industrial 2 of 5 Check Character Calculation  
= Disable



Industrial 2 of 5 Check Character Calculation = Enable



## Industrial 2 of 5 Check Character Transmission

Enables/disables transmission of an Industrial 2 of 5 check character.



Industrial 2 of 5 Check Character Transmission  
= Don't Send



★ Industrial 2 of 5 Check Character Transmission  
= Send

## Industrial 2 of 5 Length Control

This feature specifies either variable length decoding or fixed length decoding for the Industrial 2 of 5 symbology.

**Variable Length:** For variable-length decoding, a minimum length may be set.

**Fixed Length:** For fixed-length decoding, two different lengths may be set.



★ Industrial 2 of 5 Length Control = Variable Length



Industrial 2 of 5 Length Control = Fixed Length



## Industrial 2 of 5 Set Length 1

This feature specifies one of the bar code lengths for "Industrial 2 of 5 Length Control" on page 174. Length 1 is the minimum label length if in Variable Length Mode, or the first fixed length if in Fixed Length Mode. The length includes the bar code's check and data characters.

The length can be set from 1 to 50 characters. See "Set Length 1" on page 297 for more detailed programming instructions.



Select Industrial 2 of 5 Length 1 Setting

To configure this feature, scan the ENTER/EXIT PROGRAMMING MODE bar code above, then the bar code at left followed by the digits from the Alphanumeric characters in Appendix D, Keypad representing your desired character(s). End by scanning the ENTER/EXIT bar code again.

Make a mistake? Scan the CANCEL bar code to abort and not save the entry string. You can then start again at the beginning.



CANCEL

★ Length 1 = 06 (6 characters)

## Industrial 2 of 5 Set Length 2

This feature specifies one of the bar code lengths for "Industrial 2 of 5 Length Control" on page 174. Length 2 is the maximum label length if in Variable Length Mode, or the second fixed length if in Fixed Length Mode. The length includes the bar code's check and data characters.

The length can be set from 1 to 50 characters. A setting of 00 specifies to ignore this length (only one fixed length). See "Set Length 2" on page 298 for more detailed programming instructions.



Select Industrial 2 of 5 Set Length 2 Setting

To configure this feature, scan the ENTER/EXIT PROGRAMMING MODE bar code above, then the bar code at left followed by the digits from the Alphanumeric characters in Appendix D, Keypad representing your desired character(s). End by scanning the ENTER/EXIT bar code again.

Make a mistake? Scan the CANCEL bar code to abort and not save the entry string. You can then start again at the beginning.



CANCEL

★ Length 2 = 50 (50 characters)



# IATA

The following options apply to the IATA symbology.

## IATA Enable/Disable

Enables/Disables the ability of the reader to decode IATA labels.



★ IATA = Disable



IATA = Enable

## IATA Check Character Transmission

Enables/Disables calculation and verification of an optional IATA check character.



IATA Check Character Transmission  
= Don't Send



★ IATA Check Character Transmission  
= Send



## FOLLETT 2 OF 5

The following options apply to the Follett 2 of 5 symbology.

### Follett 2 of 5 Enable/Disable

Enables/Disables ability of reader to decode Follett 2 of 5 labels.



★ Follett 2 of 5 = Disable



Follett 2 of 5 = Enable



# CODABAR

The following options apply to the Codabar symbology.

## Codabar Enable/Disable

When disabled, the reader will not read Codabar bar codes.



★ Codabar = Disable



Codabar = Enable

## Codabar Check Character Calculation

This option enables/disables calculation and verification of an optional Codabar check character. When disabled, any check characters in the label are treated as data characters.



★ Codabar Check Character Calculation = Disable



Codabar Check Character Calculation  
= Calculate AIM Std Check



Codabar Check Character Calculation  
= Calculate Modulo 10 Check



Codabar Check Character Calculation  
= Calculate NW-7 Check





## Codabar Check Character Transmission

Enable this option to transmit the check character along with Codabar bar code data.



**NOTE: This feature is valid only when Codabar Check Character Calculation is enabled.**



Codabar Check Character Transmission  
= Don't Send



★ Codabar Check Character Transmission  
= Send

## Codabar Start/Stop Character Transmission

This option enables/disables transmission of Codabar start and stop characters.



Codabar Start/Stop Character Transmission  
= Don't Transmit



★ Codabar Start/Stop Character Transmission  
= Transmit



## Codabar Start/Stop Character Set

This option specifies the format of transmitted Codabar start/stop characters.



Codabar Check Character Set = ABCD/TN\*E



Codabar Check Character Set = ABCD/ABCD



Codabar Check Character Set = abcd/tn\*e



★ Codabar Check Character Set = abcd/abcd

## Codabar Start/Stop Character Match

When enabled, this option requires that start and stop characters match



★ Codabar Start/Stop Character Match  
= Don't Require Match



Codabar Start/Stop Character Match = Require Match



## Codabar Quiet Zones

This feature specifies the number of quiet zones for Codabar labels. Quiet zones are blank areas at the ends of a bar code and are typically 10 times the width of the narrowest bar or space in the label.



Codabar Quiet Zones = Quiet Zone on one side



★ Codabar Quiet Zones = Quiet Zones on two sides



Codabar Quiet Zones = Auto



Codabar Quiet Zones = Virtual Quiet Zones on two sides



Codabar Quiet Zones = Small Quiet Zones on two sides



## Codabar Length Control

This feature specifies either variable length decoding or fixed length decoding for the Codabar symbology.

**Variable Length:** For variable-length decoding, a minimum length may be set.

**Fixed Length:** For fixed-length decoding, two different lengths may be set.



★ Codabar Length Control = Variable Length



Codabar Length Control = Fixed Length

## Codabar Set Length 1

This feature specifies one of the bar code lengths for "Codabar Length Control" on page 182. Length 1 is the minimum label length if in Variable Length Mode, or the first fixed length if in Fixed Length Mode. Length includes the bar code's start, stop, check and data characters. The length must include at least one data character.

The length can be set from 3 to 50 characters. See "Set Length 1" on page 297 for more detailed programming instructions.



Select Codabar Length 1 Setting

To configure this feature, scan the ENTER/EXIT PROGRAMMING MODE bar code above, then the bar code at left followed by the digits from the Alphanumeric characters in Appendix D, Keypad representing your desired character(s). End by scanning the ENTER/EXIT bar code again.

Make a mistake? Scan the CANCEL bar code to abort and not save the entry string. You can then start again at the beginning.



CANCEL

★ Length 1 = 03 (3 characters)



## Codabar Set Length 2

This feature specifies one of the bar code lengths for "Codabar Length Control" on page 182. Length 2 is the maximum label length if in Variable Length Mode, or the second fixed length if in Fixed Length Mode. The length includes the bar code's start, stop, check and data characters. The length must include at least one data character.

The length can be set from 3 to 50 characters. A setting of 00 specifies to ignore this length (only one fixed length). See "Set Length 2" on page 298 for more detailed programming instructions.



Select Codabar Length 2 Setting

To configure this feature, scan the ENTER/EXIT PROGRAMMING MODE bar code above, then the bar code at left followed by the digits from the Alphanumeric characters in [Appendix D, Keypad](#) representing your desired character(s). End by scanning the ENTER/EXIT bar code again.

Make a mistake? Scan the CANCEL bar code to abort and not save the entry string. You can then start again at the beginning.



CANCEL

★ Length 2 = 50 (50 characters)



## ABC CODABAR

The following options apply to the ABC Codabar symbology.

### ABC Codabar Enable/Disable

Enables/Disables ability of reader to decode ABC Codabar labels.



★ ABC Codabar = Disable



ABC Codabar = Enable

### ABC Codabar Concatenation Mode

Specifies the concatenation mode between Static and Dynamic.



★ ABC Codabar Concatenation Mode = Static



ABC Codabar Concatenation Mode = Dynamic



## ABC Codabar Dynamic Concatenation Timeout

This parameter specifies the timeout in 10-millisecond ticks used by the ABC Codabar Dynamic Concatenation Mode. The timeout can be set within a range of 05 to 255 in 10ms increments. A setting of zero specifies no delay.



Select ABC Codabar Dynamic Concatenation Timeout Setting

To configure this feature, scan the ENTER/EXIT PROGRAMMING MODE bar code above, then the bar code at left followed by the digits from the Alphanumeric characters in [Appendix D, Keypad](#) representing your desired character(s). End by scanning the ENTER/EXIT bar code again.

Make a mistake? Scan the CANCEL bar code to abort and not save the entry string. You can then start again at the beginning.



CANCEL

★ Timeout = 20 (200 msec)

## ABC Codabar Force Concatenation

When ABC Codabar Concatenation is enabled and Force Concatenation is disabled, both Codabar stand alone labels and ABC Codabar concatenated labels are transmitted. When ABC Codabar Concatenation is enabled and Force Concatenation is enabled only ABC Codabar concatenated labels are transmitted while Codabar stand alone labels are not transmitted.

Force Concatenation has no effect if the ABC Codabar Concatenation is disabled. The Force Concatenation mode has effect both in Static and Dynamic Concatenation Modes.



★ ABC Codabar Force Concatenation = Disable



ABC Codabar Force Concatenation = Enable



## ISBT 128

The following options apply to the ISBT 128 symbology.

### ISBT 128 Concatenation

Enables/disables ISBT 128 concatenation of 2 labels.



★ ISBT 128 Concatenation = Disable



ISBT 128 Concatenation = Enable

### ISBT 128 Concatenation Mode

Specifies the concatenation mode between Static and Dynamic.



★ ISBT 128 Concatenation Mode = Static



ISBT 128 Concatenation Mode = Dynamic





## ISBT 128 Dynamic Concatenation Timeout

Specifies the timeout used by the ISBT 128 Dynamic Concatenation Mode.



ISBT 128 Dynamic Concatenation Timeout = 50 msec



ISBT 128 Dynamic Concatenation Timeout = 100 msec



★ ISBT 128 Dynamic Concatenation Timeout = 200 msec



ISBT 128 Dynamic Concatenation Timeout = 500 msec



ISBT 128 Dynamic Concatenation Timeout = 750 msec



ISBT 128 Dynamic Concatenation Timeout = 1 second



## ISBT 128 Force Concatenation

When enabled, this feature forces all ISBT 128 labels to be concatenated.



**NOTE: This option is only valid when "ISBT 128 Concatenation" on page 186 is enabled.**



★ ISBT 128 Force Concatenation = Disable



ISBT 128 Force Concatenation = Enable

## ISBT 128 Advanced Concatenation Options



**NOTE: Use the Datalogic Aladdin configuration application or Contact Customer Support to set up pairs of label types for concatenation.**



## CODE 11

The following options apply to the Code 11 symbology.

### Code 11 Enable/Disable

When disabled, the reader will not read Code 11 bar codes.



★ Code 11 = Disable



Code 11 = Enable

### Code 11 Check Character Calculation

This option enables/disables calculation and verification of optional Code 11 check character.



Code 11 Check Character Calculation = Disable



Code 11 Check Character Calculation = Calculate Check C



Code 11 Check Character Calculation  
= Calculate Check K



★ Code 11 Check Character Calculation  
= Calculate Check C and K



## Code 11 Check Character Transmission

This feature enables/disables transmission of an optional Code 11 check character.



Code 11 Check Character Transmission = Don't Send



★ Code 11 Check Character Transmission = Send

## Code 11 Length Control

This feature specifies either variable length decoding or fixed length decoding for the Code 11 symbology.

**Variable Length:** For variable-length decoding, a minimum length may be set.

**Fixed Length:** For fixed-length decoding, two different lengths may be set.



★ Code 11 Length Control = Variable Length



Code 11 Length Control = Fixed Length



## Code 11 Set Length 1

This feature specifies one of the bar code lengths for "Code 11 Length Control" on page 190. Length 1 is the minimum label length if in Variable Length Mode, or the first fixed length if in Fixed Length Mode. Length includes the bar code's check and data characters.

The length can be set from 2 to 50 characters. See "Set Length 1" on page 297 for more detailed programming instructions.



Select Code 11 Length 1 Setting

To configure this feature, scan the ENTER/EXIT PROGRAMMING MODE bar code above, then the bar code at left followed by the digits from the Alphanumeric characters in [Appendix D, Keypad](#) representing your desired character(s). End by scanning the ENTER/EXIT bar code again.

Make a mistake? Scan the CANCEL bar code to abort and not save the entry string. You can then start again at the beginning.



CANCEL

★ Length 1 = 04 (4 characters)

## Code 11 Set Length 2

This feature specifies one of the bar code lengths for "Code 11 Length Control" on page 190. Length 2 is the maximum label length if in Variable Length Mode, or the second fixed length if in Fixed Length Mode. Length includes the bar code's check and data characters.

The length can be set from 2 to 50 characters. A setting of 00 specifies to ignore this length (only one fixed length). See "Set Length 2" on page 298 for more detailed programming instructions.



Select Code 11 Length 2 Setting

To configure this feature, scan the ENTER/EXIT PROGRAMMING MODE bar code above, then the bar code at left followed by the digits from the Alphanumeric characters in [Appendix D, Keypad](#) representing your desired character(s). End by scanning the ENTER/EXIT bar code again.

Make a mistake? Scan the CANCEL bar code to abort and not save the entry string. You can then start again at the beginning.



CANCEL

★ Length 2 = 50 (50 characters)



## CODE 93

The following options apply to the Code 93 symbology.

### Code 93 Enable/Disable

Enables/Disables ability of reader to decode Code 93 labels.



★ Code 93 = Disable



Code 93 = Enable

### Code 93 Check Character Calculation

This option enables/disables calculation and verification of optional Code 93 check character.



Code 93 Check Character Calculation = Disable



Code 93 Check Character Calculation = Calculate Check C



Code 93 Check Character Calculation  
= Calculate Check K



★ Code 93 Check Character Calculation  
= Calculate Check C and K



## Code 93 Check Character Transmission

This feature enables/disables transmission of an optional Code 93 check character.



★ Code 93 Check Character Transmission = Don't  
Send



Code 93 Check Character Transmission = Send

## Code 93 Length Control

This feature specifies either variable length decoding or fixed length decoding for the Code 93 symbology.

**Variable Length:** For variable-length decoding, a minimum length may be set.

**Fixed Length:** For fixed-length decoding, two different lengths may be set.



★ Code 93 Length Control = Variable Length



Code 93 Length Control = Fixed Length



## Code 93 Set Length 1

This feature specifies one of the bar code lengths for "[Code 93 Length Control](#)" on page 193. Length 1 is the minimum label length if in Variable Length Mode, or the first fixed length if in Fixed Length Mode. Length includes the bar code's check and data characters.

The length can be set from 1 to 50 characters. See "[Set Length 1](#)" on page 297 for more detailed programming instructions.



Select Code 93 Length 1 Setting

To configure this feature, scan the ENTER/EXIT PROGRAMMING MODE bar code above, then the bar code at left followed by the digits from the Alphanumeric characters in [Appendix D, Keypad](#) representing your desired character(s). End by scanning the ENTER/EXIT bar code again.

Make a mistake? Scan the CANCEL bar code to abort and not save the entry string. You can then start again at the beginning.



CANCEL

★ Length 1 = 01 (one character)

## Code 93 Set Length 2

This feature specifies one of the bar code lengths for "[Code 93 Length Control](#)" on page 193. Length 2 is the maximum label length if in Variable Length Mode, or the second fixed length if in Fixed Length Mode. The length includes the bar code's check and data characters.

The length can be set from 1 to 50 characters. A setting of 00 specifies to ignore this length (only one fixed length). See "[Set Length 2](#)" on page 298 for more detailed programming instructions.



Select Code 93 Length 2 Setting

To configure this feature, scan the ENTER/EXIT PROGRAMMING MODE bar code above, then the bar code at left followed by the digits from the Alphanumeric characters in [Appendix D, Keypad](#) representing your desired character(s). End by scanning the ENTER/EXIT bar code again.

Make a mistake? Scan the CANCEL bar code to abort and not save the entry string. You can then start again at the beginning.



CANCEL

★ Length 2 = 50 (50 characters)





## Code 93 Quiet Zones

This feature specifies the number of quiet zones for Code 93 labels. Quiet zones are blank areas at the ends of a bar code and are typically 10 times the width of the narrowest bar or space in the label.



Code 93 Quiet Zones = No Quiet Zones



Code 93 Quiet Zones = Quiet Zone on one side



Code 93 Quiet Zones = Quiet Zones on two sides



★ Code 93 Quiet Zones = Auto



Code 93 Quiet Zones = Virtual Quiet Zones on two sides



## MSI

The following options apply to the MSI symbology.

### MSI Enable/Disable

Enables/Disables ability of reader to decode MSI labels.



★ MSI = Disable



MSI = Enable

### MSI Check Character Calculation

Enables/Disables calculation and verification of an optional MSI check character.



MSI Check Character Calculation = Disable



★ MSI Check Character Calculation = Calculate Mod 10



MSI Check Character Calculation  
= Calculate Mod 11/10



MSI Check Character Calculation  
= Calculate Mod 10/10



## MSI Check Character Transmission

Enables/disables transmission of an MSI check character.



MSI Check Character Transmission = Don't Send



★ MSI Check Character Transmission = Send

## MSI Length Control

This feature specifies either variable length decoding or fixed length decoding for the MSI symbology.

**Variable Length:** For variable-length decoding, a minimum length may be set.

**Fixed Length:** For fixed-length decoding, two different lengths may be set.



★ MSI Length Control = Variable Length



MSI Length Control = Fixed Length



## MSI Set Length 1

This feature specifies one of the bar code lengths for "MSI Length Control" on page 197. Length 1 is the minimum label length if in Variable Length Mode, or the first fixed length if in Fixed Length Mode. Length includes the bar code's data characters only.

The length can be set from 1 to 50 characters. See "Set Length 1" on page 297 for more detailed programming instructions.



Select MSI Length 1 Setting

To configure this feature, scan the ENTER/EXIT PROGRAMMING MODE bar code above, then the bar code at left followed by the digits from the Alphanumeric characters in [Appendix D, Keypad](#) representing your desired character(s). End by scanning the ENTER/EXIT bar code again.

Make a mistake? Scan the CANCEL bar code to abort and not save the entry string. You can then start again at the beginning.



CANCEL

★ Length 1 = 01 (one character)

## MSI Set Length 2

This feature specifies one of the bar code lengths for "MSI Length Control" on page 197. Length 2 is the maximum label length if in Variable Length Mode, or the second fixed length if in Fixed Length Mode. The length includes the bar code's data characters only.

The length can be set from 1 to 50 characters. A setting of 00 specifies to ignore this length (only one fixed length). See "Set Length 2" on page 298 for more detailed programming instructions.



Select MSI Length 2 Setting

To configure this feature, scan the ENTER/EXIT PROGRAMMING MODE bar code above, then the bar code at left followed by the digits from the Alphanumeric characters in [Appendix D, Keypad](#) representing your desired character(s). End by scanning the ENTER/EXIT bar code again.

Make a mistake? Scan the CANCEL bar code to abort and not save the entry string. You can then start again at the beginning.



CANCEL

★ Length 2 = 50 (50 characters)



## PHARMACODE

The following options apply to the Pharmacode symbology.

### Pharmacode Enable/Disable

Enables/Disables the ability of the reader to decode Pharmacode labels.



★ Pharmacode = Disable



Pharmacode = Enable

### Pharmacode Label Direction

This feature specifies the direction in which labels are decoded.



★ Pharmacode Label Direction=  
Horizontal left to right



Pharmacode Label Direction =  
Horizontal right to left



Pharmacode Label Direction =  
Vertical top down



Pharmacode Label Direction =  
Vertical bottom up



## Pharmacode Length Control

This feature specifies either variable length decoding or fixed length decoding for the Pharmacode symbology.

**Variable Length:** For variable-length decoding, a minimum length may be set.

**Fixed Length:** For fixed-length decoding, two different lengths may be set.



★ Pharmacode Length Control = Variable Length



Pharmacode Length Control = Fixed Length

## Pharmacode Set Length 1

This feature specifies one of the bar code lengths for "Pharmacode Length Control" on page 200. Length 1 is the minimum label length if in Variable Length Mode, or the first fixed length if in Fixed Length Mode. The length includes the bar code's check and data characters.

The length can be set from 2 to 6 characters. See "Set Length 1" on page 297 for more detailed programming instructions.



Select Pharmacode Length 1 Setting

To configure this feature, scan the ENTER/EXIT PROGRAMMING MODE bar code above, then the bar code at left followed by the digits from the Alphanumeric characters in Appendix D, Keypad representing your desired character(s). End by scanning the ENTER/EXIT bar code again.

Make a mistake? Scan the CANCEL bar code to abort and not save the entry string. You can then start again at the beginning.



CANCEL

★ Length 1 = 02 (two characters)



## Pharmacode Set Length 2

This feature specifies one of the bar code lengths for "[Pharmacode Set Length 2](#)" on page 201. Length 2 is the maximum label length if in Variable Length Mode, or the second fixed length if in Fixed Length Mode. The length includes the bar code's check and data characters.

Length can be set from 2 to 6 characters. A setting of 00 specifies to ignore this length (only one fixed length). See "[Set Length 2](#)" on page 298 for more detailed programming instructions.



Select Pharmacode Length 2 Setting

To configure this feature, scan the ENTER/EXIT PROGRAMMING MODE bar code above, then the bar code at left followed by the digits from the Alphanumeric characters in [Appendix D, Keypad](#) representing your desired character(s). End by scanning the ENTER/EXIT bar code again.

Make a mistake? Scan the CANCEL bar code to abort and not save the entry string. You can then start again at the beginning.



CANCEL

★ Length 2 = 6 (six characters)



# PLESSEY

The following options apply to the Plessey symbology.

## Plessey Enable/Disable

Enables/Disables the ability of the reader to decode Plessey labels.



★ Plessey = Disable



Plessey = Enable

## Plessey Check Character Calculation

Enables/Disables calculation and verification of a Plessey check character.



Plessey Check Character Calculation = Disable



★ Plessey Check Character Calculation  
= Plessey std check char. verification



Plessey Check Character Calculation  
= Anker check char. verification



Plessey Check Character Calculation  
= Plessey std and Anker check char. verification





## Plessey Check Character Transmission

Enables/disables transmission of a Plessey check character.



Plessey Check Character Transmission = Don't Send



★ Plessey Check Character Transmission = Send

## Plessey Length Control

This feature specifies either variable length decoding or fixed length decoding for the Plessey symbology.

**Variable Length:** For variable-length decoding, a minimum length may be set.

**Fixed Length:** For fixed-length decoding, two different lengths may be set.



★ Plessey Length Control = Variable Length



Plessey Length Control = Fixed Length



## Plessey Set Length 1

This feature specifies one of the bar code lengths for "Plessey Length Control" on page 203. Length 1 is the minimum label length if in Variable Length Mode, or the first fixed length if in Fixed Length Mode. The length includes the bar code's check and data characters.

The length can be set from 1 to 50 characters. See "Set Length 1" on page 297 for more detailed programming instructions.



Select Plessey Length 1 Setting

To configure this feature, scan the ENTER/EXIT PROGRAMMING MODE bar code above, then the bar code at left followed by the digits from the Alphanumeric characters in [Appendix D, Keypad](#) representing your desired character(s). End by scanning the ENTER/EXIT bar code again.

Make a mistake? Scan the CANCEL bar code to abort and not save the entry string. You can then start again at the beginning.



CANCEL

★ Length 1 = 01 (one character)

## Plessey Set Length 2

This feature specifies one of the bar code lengths for "Plessey Length Control" on page 203. Length 2 is the maximum label length if in Variable Length Mode, or the second fixed length if in Fixed Length Mode. The length includes the bar code's check and data characters.

Length can be set from 1 to 50 characters. A setting of 00 specifies to ignore this length (only one fixed length). See "Set Length 2" on page 298 for more detailed programming instructions.



Select Plessey Length 2 Setting

To configure this feature, scan the ENTER/EXIT PROGRAMMING MODE bar code above, then the bar code at left followed by the digits from the Alphanumeric characters in [Appendix D, Keypad](#) representing your desired character(s). End by scanning the ENTER/EXIT bar code again.

Make a mistake? Scan the CANCEL bar code to abort and not save the entry string. You can then start again at the beginning.



CANCEL

★ Length 2 = 50 (50 characters)



## BC412

The following options apply to the BC412 symbology.

### BC412 Enable/Disable

Enables/Disables ability of reader to decode BC412 labels.



★ BC412 = Disable



BC412 = Enable

### BC412 Check Character Calculation

Enable this option to enable/disable calculation and verification of an optional BC412 check character. When disabled, any check character in the label is treated as a data character.



BC412 Check Character Calculation = Disable



★ BC412 Check Character Calculation = Calculate



## BC412 Length Control

This feature specifies either variable length decoding or fixed length decoding for the BC412 symbology.

**Variable Length:** For variable-length decoding, a minimum length may be set.

**Fixed Length:** For fixed-length decoding, two different lengths may be set.



★ BC412 Length Control = Variable Length



BC412 Length Control = Fixed Length



## BC412 Set Length 1

This feature specifies one of the bar code lengths for "BC412 Length Control" on page 206. Length 1 is the minimum label length if in Variable Length Mode, or the first fixed length if in Fixed Length Mode. Length includes the bar code's data characters only.

The length can be set from 01 to 50 characters. See "Set Length 1" on page 297 for more detailed programming instructions.



Select BC412 Length 1 Setting

To configure this feature, scan the ENTER/EXIT PROGRAMMING MODE bar code above, then the bar code at left followed by the digits from the Alphanumeric characters in [Appendix D, Keypad](#) representing your desired character(s). End by scanning the ENTER/EXIT bar code again.

Make a mistake? Scan the CANCEL bar code to abort and not save the entry string. You can then start again at the beginning.



CANCEL

★ Length 1 = 01 (one character)

## BC412 Set Length 2

This feature specifies one of the bar code lengths for "BC412 Length Control" on page 206. Length 2 is the maximum label length if in Variable Length Mode, or the second fixed length if in Fixed Length Mode. Length includes the bar code's data characters only.

The length can be set from 01 to 50 characters. A setting of 00 specifies to ignore this length (only one fixed length). See "Set Length 2" on page 298 for more detailed programming instructions.



Select BC412 Length 2 Setting

To configure this feature, scan the ENTER/EXIT PROGRAMMING MODE bar code above, then the bar code at left followed by the digits from the Alphanumeric characters in [Appendix D, Keypad](#) representing your desired character(s). End by scanning the ENTER/EXIT bar code again.

Make a mistake? Scan the CANCEL bar code to abort and not save the entry string. You can then start again at the beginning.



CANCEL

★ Length 2 = 50 (50 characters)

# CONFIGURATION | 2D SYMBOLOGIES

## SECTION CONTENTS

- **2D GLOBAL FEATURES** starting on page 209
- **AZTEC CODE** starting on page 212
- **CHINA SENSIBLE CODE** starting on page 214
- **DATA MATRIX** starting on page 216
- **GS1 DotCODE** starting on page 219
- **MAXICODE** starting on page 221
- **PDF417** starting on page 224
- **MICRO PDF417** starting on page 226
- **QR CODE** starting on page 229
- **MICRO QR CODE** starting on page 231
- **UCC COMPOSITE** starting on page 233

The reader supports the following 2D symbologies (bar code types). Symbology-dependent options for each symbology are included in this chapter.  
See [1D Symbologies, starting on page 118](#) for configuration of 1D bar codes.

---

## 2D GLOBAL FEATURES

The following features are common to all, or in some cases, most of the available 2D symbologies. Default settings are indicated at each feature/option with a green arrow. Also reference Appendix B, Standard Defaults for a listing of the most widely used set of standard factory settings. That section also provides space to record any custom settings needed or implemented for your system.

To set most features:

1. Scan the ENTER/EXIT PROGRAMMING bar code at the top of applicable programming pages.
2. Scan the correct bar code to set the desired programming feature or parameter. You may need to cover unused bar codes on the page, and possibly the facing page, to ensure that the reader reads only the bar code you intend to scan.
3. If additional input parameters are needed, go to Appendix D, Keypad, and scan the appropriate characters from the keypad.



**NOTE: Additional information about many features can be found in the “References” chapter.**

**If you make a mistake before the last character, scan the CANCEL bar code to abort and not save the entry string. You can then start again at the beginning.**

Complete the programming sequence by scanning the ENTER/EXIT PROGRAMMING bar code to exit Programming Mode.



## 2D Maximum Decoding Time

This feature specifies the maximum amount of time the software will spend attempting to decode a 2D label. The selectable range is 10 milliseconds to 2.55 milliseconds.



2D Maximum Decoding Time = 100 msec



2D Maximum Decoding Time = 200 msec



★ 2D Maximum Decoding Time = 350 msec



2D Maximum Decoding Time = 500 msec



2D Maximum Decoding Time = 1 Second



2D Maximum Decoding Time = 2 Seconds



2D Maximum Decoding Time = 2.55 Seconds





## 2D Structured Append

Enables/disables ability of reader to append multiple 2D Codes labels in a structured format. The structured append property is globally applied to the following symbologies, if these are enabled:

- Data Matrix
- Aztec
- QR Code
- PDF 417



★ Structured Append = Disable



Structured Append = Enable

## 2D Normal/Inverse Symbol Control

Specifies the options available for decoding normal/negative printed 2D symbols. This configuration item applies globally to all the 2D symbologies that support that feature according to Standard AIM Specification: Data Matrix, QR, MicroQR, Aztec and Chinese Sensible Code.



★ Normal/Inverse Symbol Control = Normal



Normal/Inverse Symbol Control = Inverse



Normal/Inverse Symbol Control = Both Normal and Inverse



## AZTEC CODE

### Aztec Code Enable / Disable

Enables/disables the ability of the reader to decode Aztec Code labels.



Aztec Code = Disable



★ Aztec Code = Enable

### Aztec Code Length Control

This feature specifies either variable length decoding or fixed length decoding for this symbology.

**Variable Length:** For variable length decoding, a minimum and maximum length may be set.

**Fixed Length:** For fixed length decoding, two different lengths may be set.



★ Aztec Code Length Control = Variable Length



Aztec Code Length Control = Fixed Length



## Aztec Code Set Length 1

Specifies one of the bar code lengths for "Aztec Code Length Control" on page 212.

Length 1 is the minimum label length if in Variable Length Mode, or the first fixed length if in Fixed Length Mode. Characters can be set from 0001 to 3,832 characters in increments of 0001 (pad with zeroes).

See "Set Length 1" on page 297 for detailed instructions on setting this feature.



Select Aztec Code Length 1 Setting

To configure this feature, scan the ENTER/EXIT PROGRAMMING MODE bar code above, then the bar code at left followed by the digits from the Alphanumeric characters in [Appendix D, Keypad](#) representing your desired character(s). End by scanning the ENTER/EXIT bar code again.

Make a mistake? Scan the CANCEL bar code to abort and not save the entry string. You can then start again at the beginning.



CANCEL

★0001 = Length 1 is 1 Character

## Aztec Code Set Length 2

Specifies one of the bar code lengths for "Aztec Code Length Control" on page 212.

Length 2 is the minimum label length if in Variable Length Mode, or the first fixed length if in Fixed Length Mode. Characters can be set from 0001 to 3,832 characters in increments of 0001 (pad with zeroes).

See "Set Length 2" on page 298 for detailed instructions on setting this feature.



Select Aztec Code Length 2 Setting

To configure this feature, scan the ENTER/EXIT PROGRAMMING MODE bar code above, then the bar code at left followed by the digits from the Alphanumeric characters in [Appendix D, Keypad](#) representing your desired character(s). End by scanning the ENTER/EXIT bar code again.

Make a mistake? Scan the CANCEL bar code to abort and not save the entry string. You can then start again at the beginning.



CANCEL

★Length 2 is 3,832 Characters



## CHINA SENSIBLE CODE

### China Sensible Code Enable / Disable

Enables/disables the ability of the reader to decode China Sensible Code labels.



★ China Sensible Code = Disable



China Sensible Code = Enable

### China Sensible Code Length Control

This feature specifies either variable length decoding or fixed length decoding for this symbology.

**Variable Length:** For variable length decoding, a minimum and maximum length may be set.

**Fixed Length:** For fixed length decoding, two different lengths may be set.



★ China Sensible Code Length Control = Variable Length



China Sensible Code Length Control = Fixed Length



## China Sensible Code Set Length 1

Specifies one of the bar code lengths for "China Sensible Code Length Control" on page 214. Length 1 is the minimum label length if in Variable Length Mode, or the first fixed length if in Fixed Length Mode. Characters can be set from 0001 to 7,827 characters in increments of 0001 (pad with zeroes).

See "Set Length 1" on page 297 for detailed instructions on setting this feature.



Select China Sensible Code Length 1 Setting

To configure this feature, scan the ENTER/EXIT PROGRAMMING MODE bar code above, then the bar code at left followed by the digits from the Alphanumeric characters in [Appendix D, Keypad](#) representing your desired character(s). End by scanning the ENTER/EXIT bar code again.

Make a mistake? Scan the CANCEL bar code to abort and not save the entry string. You can then start again at the beginning.



CANCEL

★0001 = Length 1 is 1 Character

## China Sensible Code Set Length 2

This feature specifies one of the bar code lengths for "China Sensible Code Length Control" on page 214. Length 2 is the maximum label length if in Variable Length Mode, or the second fixed length if in Fixed Length Mode. Characters can be set from 0001 to 7,827 characters in increments of 0001 (pad with zeroes).

See "Set Length 2" on page 298 for detailed instructions on setting this feature.



Select China Sensible Code Length 2 Setting

To configure this feature, scan the ENTER/EXIT PROGRAMMING MODE bar code above, then the bar code at left followed by the digits from the Alphanumeric characters in [Appendix D, Keypad](#) representing your desired character(s). End by scanning the ENTER/EXIT bar code again.

Make a mistake? Scan the CANCEL bar code to abort and not save the entry string. You can then start again at the beginning.



CANCEL

★Length 2 is 7,827 Characters



# DATA MATRIX

## Data Matrix Enable / Disable

Enables/disables ability of reader to decode Data Matrix labels.



Data Matrix = Disable



★ Data Matrix = Enable

## Data Matrix Square/Rectangular Style

Specifies the options available when reading Data Matrix with different form factors.

Choices are:

- Square Style
- Rectangular Style
- Both Square and Rectangular Style

The configuration item can also be configured as a bit mask to filter one or more Data Matrix labels with different symbol size AND shape styles.



Data Matrix Dimensions Mask = Square Style



Data Matrix Dimensions Mask = Rectangular Style



★ Data Matrix Dimensions Mask = Both Square and Rectangular Style



## Data Matrix Length Control

This feature specifies either variable length decoding or fixed length decoding for this symbology.

**Variable Length:** For variable length decoding, a minimum and maximum length may be set.

**Fixed Length:** For fixed length decoding, two different lengths may be set.



★ Data Matrix Length Control = Variable Length



Data Matrix Length Control = Fixed Length

## Data Matrix Set Length 1

This feature specifies one of the bar code lengths for "Data Matrix Length Control" on page 217. Length 1 is the minimum label length if in Variable Length Mode, or the first fixed length if in Fixed Length Mode. Characters can be set from 0001 to 3,116 characters in increments of 0001 (pad with zeroes).

See "Set Length 1" on page 297 for detailed instructions on setting this feature.



Select Data Matrix Length 1 Setting

To configure this feature, scan the ENTER/EXIT PROGRAMMING MODE bar code above, then the bar code at left followed by the digits from the Alphanumeric characters in Appendix D, Keypad representing your desired character(s). End by scanning the ENTER/EXIT bar code again.

Make a mistake? Scan the CANCEL bar code to abort and not save the entry string. You can then start again at the beginning.



CANCEL

★ 0001 = Length 1 is 1 Character



## Data Matrix Set Length 2

This feature specifies one of the bar code lengths for "Data Matrix Length Control" on [page 217](#). Length 2 is the maximum label length if in Variable Length Mode, or the second fixed length if in Fixed Length Mode. Characters can be set from 0001 to 3,116 characters in increments of 0001 (pad with zeroes).

See "[Set Length 2](#)" on [page 298](#) for detailed instructions on setting this feature.



Select Data Matrix Length 2 Setting

To configure this feature, scan the ENTER/EXIT PROGRAMMING MODE bar code above, then the bar code at left followed by the digits from the Alphanumeric characters in [Appendix D, Keypad](#) representing your desired character(s). End by scanning the ENTER/EXIT bar code again.

Make a mistake? Scan the CANCEL bar code to abort and not save the entry string. You can then start again at the beginning.



CANCEL

★ Length 2 is 3,116 Characters





## GS1 DOTCODE

The following options apply for the DotCode barcode decoding

### DotCode Enable

This options enables/disables the ability of the reader to decode DotCode barcodes.



DotCode = Enable



★ DotCode = Disable

### DotCode High Resolution Enable

This options improves the decoding performance for very small module size barcodes, e.g. tobacco products.



★ DotCode High Resolution = Enable



DotCode High Resolution = Disable



## DotCode Position-based Decoding

This option can improve the decoding performance when the next barcode to be decoded is approximately shown in the same position as the previous one.



DotCode Position-based Decoding = Enable



★ DotCode Position-based Decoding = Disable

## Additional Options

To improve performances the following additional settings are available using Aladdin configuration utility, downloadable from [www.datalogic.com](http://www.datalogic.com).

- Dot Size
- Fixed Length or Variable Length
- Min and Max barcode size



## MAXICODE

### Maxicode Enable / Disable

Enables/disables ability of reader to decode Maxicode labels.



★ Maxicode = Disable



Maxicode = Enable

### Maxicode Primary Message Transmission

Enables/disables the transmission of only the Primary Message when the Secondary Message is not readable.



★ Maxicode Primary Message Transmission = Disable



Maxicode Primary Message Transmission = Enable



## Maxicode Length Control

This feature specifies either variable length decoding or fixed length decoding for this symbology.

**Variable Length:** For variable length decoding, a minimum and maximum length may be set.

**Fixed Length:** For fixed length decoding, two different lengths may be set.



★ Maxicode Length Control = Variable Length



Maxicode Length Control = Fixed Length

## Maxicode Set Length 1

Specifies one of the bar code lengths for "Maxicode Length Control" on page 222. Length 1 is the minimum label length if in Variable Length Mode, or the first fixed length if in Fixed Length Mode. Characters can be set from 0001 to 0145 characters in increments of 0001 (pad with zeroes).

See "Set Length 1" on page 297 for detailed instructions on setting this feature.



Select Maxicode Length 1 Setting

To configure this feature, scan the ENTER/EXIT PROGRAMMING MODE bar code above, then the bar code at left followed by the digits from the Alphanumeric characters in Appendix D, Keypad representing your desired character(s). End by scanning the ENTER/EXIT bar code again.

Make a mistake? Scan the CANCEL bar code to abort and not save the entry string. You can then start again at the beginning.



CANCEL

★ 0001 = Length 1 is 1 Character



## Maxicode Set Length 2

This feature specifies one of the bar code lengths for "[Maxicode Length Control](#)" on [page 222](#). Length 2 is the maximum label length if in Variable Length Mode, or the second fixed length if in Fixed Length Mode. Characters can be set from 0001 to 0145 characters in increments of 0001 (pad with zeroes).

See "[Set Length 2](#)" on [page 298](#) for detailed instructions on setting this feature.



Select Maxicode Length 2 Setting

To configure this feature, scan the ENTER/EXIT PROGRAMMING MODE bar code above, then the bar code at left followed by the digits from the Alphanumeric characters in [Appendix D, Keypad](#) representing your desired character(s). End by scanning the ENTER/EXIT bar code again.

Make a mistake? Scan the CANCEL bar code to abort and not save the entry string. You can then start again at the beginning.



CANCEL

★ Length 2 is 0145 Characters



# PDF417

## PDF417 Enable / Disable

Enables/disables the ability of the reader to decode PDF417 labels.



PDF417 = Disable



★ PDF417 = Enable

## PDF417 Length Control

This feature specifies either variable length decoding or fixed length decoding for this symbology.

**Variable Length:** For variable length decoding, a minimum and maximum length may be set.

**Fixed Length:** For fixed length decoding, two different lengths may be set.



★ PDF417 Length Control = Variable Length



PDF417 Length Control = Fixed Length



## PDF417 Set Length 1

Specifies one of the bar code lengths for "PDF417 Length Control" on page 224. Length 1 is the minimum label length if in Variable Length Mode, or the first fixed length if in Fixed Length Mode. Length includes the bar code's data characters only. Characters can be set from 0001 to 2,710 characters (pad with zeroes) in increments of 01. Any value greater than 2,710 will be considered to be 2,710.

See "Set Length 1" on page 297 for detailed instructions on setting this feature.



Select PDF417 Length 1 Setting

To configure this feature, scan the ENTER/EXIT PROGRAMMING MODE bar code above, then the bar code at left followed by the digits from the Alphanumeric characters in Appendix D, Keypad representing your desired character(s). End by scanning the ENTER/EXIT bar code again.

Make a mistake? Scan the CANCEL bar code to abort and not save the entry string. You can then start again at the beginning.



CANCEL

★0001 = Length 1 is 1 Character

## PDF417 Set Length 2

This feature specifies one of the bar code lengths for "PDF417 Length Control" on page 224. Length 2 is the maximum label length if in Variable Length Mode, or the second fixed length if in Fixed Length Mode. Length includes the bar code's check, data, and full-ASCII shift characters. The length does not include start/stop characters. Characters can be set from 01 to 2,710 characters (pad with zeroes) in increments of 01. Any value greater than 2,710 will be considered to be 2,710.

See "Set Length 2" on page 298 for detailed instructions on setting this feature.



Select PDF417 Length 2 Setting

To configure this feature, scan the ENTER/EXIT PROGRAMMING MODE bar code above, then the bar code at left followed by the digits from the Alphanumeric characters in Appendix D, Keypad representing your desired character(s). End by scanning the ENTER/EXIT bar code again.

Make a mistake? Scan the CANCEL bar code to abort and not save the entry string. You can then start again at the beginning.



CANCEL

★Length 2 is 2,710 Characters



## MICRO PDF417

### Micro PDF417 Enable / Disable

Enables/disables the ability of the reader to decode Micro PDF417 labels.



Micro PDF417 = Disable



★ Micro PDF417 = Enable

### Micro PDF417 Code 128 GS1-128 Emulation

Specifies which AIM ID to use for Micro PDF labels when doing Code 128 or GS1-128 emulation.

Emulation choices are:

- Micro PDF AIM ID and label type
- Code 128 / EAN128 AIM Id and label type.



★ Micro PDF417 Code 128 GS1-128 Emulation =  
Micro PDF AIM ID and label type



Micro PDF417 Code 128 GS1-128 Emulation =  
Code 128 / EAN128 AIM ID and label type





## Micro PDF417 Length Control

This feature specifies either variable length decoding or fixed length decoding for this symbology.

**Variable Length:** For variable length decoding, a minimum and maximum length may be set.

**Fixed Length:** For fixed length decoding, two different lengths may be set.



★ Micro PDF417 Length Control = Variable Length



Micro PDF417 Length Control = Fixed Length

## Micro PDF417 Set Length 1

Specifies one of the bar code lengths for "Micro PDF417 Length Control" on page 227. Length 1 is the minimum label length if in Variable Length Mode, or the first fixed length if in Fixed Length Mode. Length includes the bar code's data characters only. Characters can be set from 0001 to 0366 characters (pad with zeroes) in increments of 01. Any value greater than 0366 will be considered to be 0366.

See "Set Length 1" on page 297 for detailed instructions on setting this feature.



Select Micro PDF417 Length 1 Setting

To configure this feature, scan the ENTER/EXIT PROGRAMMING MODE bar code above, then the bar code at left followed by the digits from the Alphanumeric characters in [Appendix D, Keypad](#) representing your desired character(s). End by scanning the ENTER/EXIT bar code again.

Make a mistake? Scan the CANCEL bar code to abort and not save the entry string. You can then start again at the beginning.



CANCEL

★ 0001 = Length 1 is 1 Character



## Micro PDF417 Set Length 2

This feature specifies one of the bar code lengths for "[Micro PDF417 Length Control](#)" on [page 227](#). Length 2 is the maximum label length if in Variable Length Mode, or the second fixed length if in Fixed Length includes the bar code's data characters only. Characters can be set from 0001 to 0366 characters (pad with zeroes) in increments of 01. Any value greater than 0366 will be considered to be 0366.

See "[Set Length 2](#)" on [page 298](#) for detailed instructions on setting this feature.



Select Micro PDF417 Length 2 Setting

To configure this feature, scan the ENTER/EXIT PROGRAMMING MODE bar code above, then the bar code at left followed by the digits from the Alphanumeric characters in [Appendix D, Keypad](#) representing your desired character(s). End by scanning the ENTER/EXIT bar code again.

Make a mistake? Scan the CANCEL bar code to abort and not save the entry string. You can then start again at the beginning.



CANCEL

★ Length 2 is 0366 Characters



## QR CODE

### QR Code Enable / Disable

Enables/disables the ability of the reader to decode QR Code labels.



QR Code = Disable



★ QR Code = Enable

### QR Code Length Control

This feature specifies either variable length decoding or fixed length decoding for this symbology.

**Variable Length:** For variable length decoding, a minimum and maximum length may be set.

**Fixed Length:** For fixed length decoding, two different lengths may be set.



★ QR Code Length Control = Variable Length



QR Code Length Control = Fixed Length



## QR Code Set Length 1

This feature specifies one of the bar code lengths for "QR Code Length Control" on page 229. Length 1 is the minimum label length if in Variable Length Mode, or the first fixed length if in Fixed Length Mode. Characters can be set from 0001 to 7,089 characters in increments of 0001 (pad with zeroes).

See "Set Length 1" on page 297 for detailed instructions on setting this feature.



Select QR Code Length 1 Setting

To configure this feature, scan the ENTER/EXIT PROGRAMMING MODE bar code above, then the bar code at left followed by the digits from the Alphanumeric characters in Appendix D, Keypad representing your desired character(s). End by scanning the ENTER/EXIT bar code again.

Make a mistake? Scan the CANCEL bar code to abort and not save the entry string. You can then start again at the beginning.



CANCEL

★ 0001 = Length 1 is 1 Character

## QR Code Set Length 2

This feature specifies one of the bar code lengths for "QR Code Length Control" on page 229. Length 2 is the maximum label length if in Variable Length Mode, or the second fixed length if in Fixed Length Mode. Characters can be set from 0001 to 7,089 characters in increments of 0001 (pad with zeroes).

See "Set Length 2" on page 298 for detailed instructions on setting this feature.



Select QR Code Length 2 Setting

To configure this feature, scan the ENTER/EXIT PROGRAMMING MODE bar code above, then the bar code at left followed by the digits from the Alphanumeric characters in Appendix D, Keypad representing your desired character(s). End by scanning the ENTER/EXIT bar code again.

Make a mistake? Scan the CANCEL bar code to abort and not save the entry string. You can then start again at the beginning.



CANCEL

★ Length 2 is 7,089 Characters



## MICRO QR CODE

### Micro QR Code Enable / Disable

Enables/disables the ability of the reader to decode Micro QR Code labels.



Micro QR Code = Disable



★ Micro QR Code = Enable

### Micro QR Code Length Control

This feature specifies either variable length decoding or fixed length decoding for this symbology.

**Variable Length:** For variable length decoding, a minimum and maximum length may be set.

**Fixed Length:** For fixed length decoding, two different lengths may be set.



★ Micro QR Code Length Control = Variable Length



Micro QR Code Length Control = Fixed Length



## Micro QR Code Set Length 1

This feature specifies one of the bar code lengths for "[Micro QR Code Length Control](#)" on [page 231](#). Length 1 is the minimum label length if in Variable Length Mode, or the first fixed length if in Fixed Length Mode. Characters can be set from 0001 to 0035 characters in increments of 0001 (pad with zeroes).

See "[Set Length 1](#)" on [page 297](#) for detailed instructions on setting this feature.



Select Micro QR Code Length 1 Setting

To configure this feature, scan the ENTER/EXIT PROGRAMMING MODE bar code above, then the bar code at left followed by the digits from the Alphanumeric characters in [Appendix D, Keypad](#) representing your desired character(s). End by scanning the ENTER/EXIT bar code again.

Make a mistake? Scan the CANCEL bar code to abort and not save the entry string. You can then start again at the beginning.



CANCEL

★ 0001 = Length 1 is 1 Character

## Micro QR Code Set Length 2

This feature specifies one of the bar code lengths for "[Micro QR Code Length Control](#)" on [page 231](#). Length 2 is the maximum label length if in Variable Length Mode, or the second fixed length if in Fixed Length Mode. Characters can be set from 0001 to 0035 characters in increments of 0001 (pad with zeroes).

See "[Set Length 2](#)" on [page 298](#) for detailed instructions on setting this feature.



Select Micro QR Code Length 2 Setting

To configure this feature, scan the ENTER/EXIT PROGRAMMING MODE bar code above, then the bar code at left followed by the digits from the Alphanumeric characters in [Appendix D, Keypad](#) representing your desired character(s). End by scanning the ENTER/EXIT bar code again.

Make a mistake? Scan the CANCEL bar code to abort and not save the entry string. You can then start again at the beginning.



CANCEL

★ Length 2 is 0035 Characters



## UCC COMPOSITE

### UCC Optional Composite Timer

Specifies the amount of time the system will wait for the stacked part of a UCC Composite label before transmitting the linear label without an add-on.



★ UCC Optional Composite Timer = Timer Disabled



UCC Optional Composite Timer = 70 msec



UCC Optional Composite Timer = 100 msec



UCC Optional Composite Timer = 200 msec



UCC Optional Composite Timer = 300 msec



## Postal Code Selection

Enables/disables the ability of the reader to decode labels of a specific postal symbol-ogy.

- Disable All Postal Codes
- Postnet
- Planet
- Royal Mail
- Kix
- Australia Post
- Japan Post
- IMB
- Sweden Post
- Portugal Post



★ Postal Code Selection = Disable All Postal Codes



Postal Code Selection = Enable Postnet



Postal Code Selection = Enable Planet



Postal Code Selection = Enable Royal Mail



Postal Code Selection = Enable Kix



Postal Code Selection = Enable Australia Post



Postal Code Selection = Enable Japan Post





## Postal Code Selection (continued)



Postal Code Selection = Enable IMB



Postal Code Selection = Enable Sweden Post



Postal Code Selection = Enable Portugal Post

## Postnet BB Control

Controls the ability of the reader to decode B and B' fields of Postnet labels.



★ Postnet BB Control = Disable



Postnet BB Control = Enable

# CONFIGURATION | OCR DECODING

The GX45 bar code family is equipped with an Optical Character Recognition feature.

This section describes how to configure the Datalogic bar code reader to enable OCR decoding.

The Gx45 models support the following OCR font types:

- OCR-A
- OCR-B
- MICR E13B
- US Currency Serial Number.

In most OCR applications a suitable usage of check digits and the addition of constraints on sub-strings types (e.g. digits-only or letter-only) reduces misdecoding probabilities.

The user can choose between a set of predefined templates (already optimized for decoding) and customizable free templates.

For free templates, as OCR decoding is less reliable than traditional barcode decoding, the reader provides tools to minimize misdecoded labels. As a result, particular care shall be dedicated to the setup of free custom templates to reduce incorrect output.

For more information on how to customize the user templates for your needs, please contact Datalogic Technical Support.

Use one of the following labels to enable one of the predefined templates for OCR decoding.



## OCR Decoding Predefined Templates

The following selections are exclusive, enabling one template automatically disables the others.



★ OCR Predefined Template = Disable OCR Function



OCR Predefined Template = EU Identity Card OCR



OCR Predefined Template = IATA Passport OCR



OCR Predefined Template = Italian Post OCR Payment



OCR Predefined Template = Italian Bank  
Freccia Bank Payment form



OCR Predefined Template = Swiss Driving License OCR

# CONFIGURATION | MOTION FEATURES

## SECTION CONTENTS

### **MOTION FEATURES** [starting on page 238](#)

- Motionless Timeout
- Motion Sensitivity
- High Motion Immunity
- Motion Aiming Control

Use this chapter to configure motion settings for the handheld.  
Reference Appendix B, for a listing of standard factory settings.



## Motionless Timeout

The period of time that must expire without detecting any motion, before the reader is assumed to be in a motionless condition. The selectable setting is from 500 to 25,500 milliseconds in 100 millisecond increments. This option relates to such features as Aimer On and Stand Mode/Object Detection scanning with respect to motion.



Select Motionless Timeout

To configure this feature, scan the ENTER/EXIT PROGRAMMING MODE bar code above, then the bar code at left followed by the digits from the Alphanumeric characters in [Appendix D, Keypad](#) representing your desired character(s). End by scanning the ENTER/EXIT bar code again.

Make a mistake? Scan the CANCEL bar code to abort and not save the entry string. You can then start again at the beginning.



CANCEL

★ 020 = Motionless Timeout = 2 seconds

## Motion Sensitivity

Sets the sensitivity level for motion detection wakeup. Choices are low, medium and high.



Motion Sensitivity = Low



★ Motion Sensitivity = Medium



Motion Sensitivity = High



## High Motion Immunity

When set to triggerless scanning mode (e.g. Flashing, Always On, Stand Mode/Object Detection, etc.) the reading capabilities can be modified according to two main goals:

- increased performance for rapidly moving barcodes - Enable High Motion Immunity:
- increased performance for distant barcodes - Disable High Motion Immunity:

Depending on specific environmental conditions, application requirements, or expected performance, choose the best solution.



★ High Motion Immunity = Disable



High Motion Immunity = Enable

## Motion Aiming Control

Enables/Disables the Aiming system when motion is detected.



Motion Aiming Control = Disable



★ Motion Aiming Control = Enable

# CONFIGURATION | POWER MANAGEMENT

SECTION CONTENTS	
<b>POWER SAVE</b> starting on page 242	
• Powerdown Timeout	
<b>BATTERY PROFILES</b> starting on page 243	
• Battery Profiles	• Battery Information

These parameters refer to Mobile units only (either GBT4500 or GM4500 models).



## POWER SAVE

### Powerdown Timeout

The Powerdown Timeout feature sets the time for automatically switching the unit off when the imager has been idle.



Powerdown Timeout = Disable



Powerdown Timeout = 10 minutes



Powerdown Timeout = 20 minutes



★ Powerdown Timeout = 30 minutes



Powerdown Timeout = 60 minutes (1 hour)



Powerdown Timeout = 120 minutes (2 hours)





## BATTERY PROFILES

### Battery Profiles

Gryphon GBT/GM4500 provides the user the ability to select different usage profiles to better configure the reader with respect to specific needs. By default, the Maximum Performance profile is selected and provides high snappiness and max reading capability. The user can then decide to exploit specific features when others are considered less important, for instance: fast battery recharge instead of battery health, maximum reading performance instead of battery autonomy, etc.

The following Battery Profiles are described with associated benefits and limitations:



★ Battery Profile = Maximum Performance



Battery Profile = Maximum Battery Health



Battery Profile = Maximum Autonomy



Battery Profile = Fast Charge



### Maximum Performance (default)

- Reader autonomy for heavy workload (80.000 scans for more than 22h)
- Motionix™ enabled
- Max radio communication performances



### Maximum Battery Health

- Battery capacity is preserved
- Reduced max charging current
- Reduced battery capacity by ~20%
- Increased recharge time: +20% on average (it depends on the specific reader configuration)



### Maximum Autonomy

- Max reader autonomy (approx. 83h)
- Motionix™ disabled
- Vibro motor disabled
- Reduced Radio Star™ responsiveness
- Increased Sniff-time period (Bluetooth®)



### Fast Charge

- Reduced recharge time (approx. 20%)
- Motionix™ disabled
- Vibro motor disabled
- Scan-While-Charging disabled (Trigger Single)

## Battery Information

By using Datalogic Aladdin utility, additional battery data can be retrieved, i.e.:

- HH Serial Number
- Charge %
- Health %
- Full Charge Capacity
- Designed Capacity
- Nominal Capacity
- Remaining Capacity
- Discharging Counter
- Charging Status
- Charging (base station) Battery Voltage
- Battery Current
- Manufacturer Date
- Battery Serial Number
- Battery Model Number

If more than one reader is connected to a base station, battery data will be retrieved for each reader.

# CONFIGURATION | WIRELESS FEATURES

## SECTION CONTENTS

### **WIRELESS BEEPER FEATURES** starting on page 246

- Good Transmission Beep
- Beeper Frequency
- Beep Duration
- Beep Volume
- Disconnect Beep
- Docking (Connecting) Beep
- Leash Alarm

### **CONFIGURATION UPDATES** starting on page 251

- Automatic Configuration Update
- Copy Configuration to Reader
- Copy Configuration to Base Station

### **BATCH FEATURES** starting on page 252

- Batch Mode
- Send Batch
- Erase Batch Memory
- RF Batch Mode Transmit Delay

### **DIRECT RADIO AUTOLINK** starting on page 254

- Direct Radio Autolink

### **RF ADDRESS STAMPING** starting on page 255

- Source Radio Address Transmission
- Source Radio Address Delimiter Character

### **BLUETOOTH-ONLY FEATURES** starting on page 256

- Bluetooth Security Level
- Bluetooth Radio Output Power
- Wi-Fi Channels Exclusion

### **BLUETOOTH HID FEATURES** starting on page 263

- Bluetooth HID Alt Mode

### **FEATURES FOR STAR MODELS ONLY** starting on page 264

- STAR Radio Protocol Timeout
- STAR Radio Transmit Mode
- STAR System Speed
- STAR Frequency Agility



## WIRELESS BEEPER FEATURES

Several options are available to configure beeper behavior for RF operation.

### Good Transmission Beep

Enables/disables the Good Transmission Beep indication. When enabled, a beep occurs when a Label is correctly transmitted to the base.



Good Transmission Beep = Disable



★ Good Transmission Beep = Enable

### Beeper Frequency

Adjusts radio-specific beep indications to sound at a low, medium or high frequency, selectable from the list below (controls the beeper's pitch/tone).



★ Beeper Frequency = Low



Beeper Frequency = Medium



Beeper Frequency = High



## Beep Duration

This feature controls the duration of radio-specific beep indications.



Beep Duration = 60 msec



★ Beep Duration = 80 msec



Beep Duration = 100 msec



Beep Duration = 120 msec



Beep Duration = 140 msec



Beep Duration = 160 msec



Beep Duration = 180 msec



Beep Duration = 200 msec



## Beep Volume

Selects the beeper volume (loudness) of radio-specific beep indications. There are three selectable volume levels.



Beep Volume = Low



Beep Volume = Medium



★ Beep Volume = High

## Disconnect Beep

Enables/disables the beep indication that a handheld has become disconnected from a Base Station.



Disconnect Beep = Disable



★ Disconnect Beep = Enable



## Docking (Connecting) Beep

Enables/disables a beep indication when the handheld is placed in the Base Station.



Docking Beep = Disable



★ Docking Beep = Enable

## Leash Alarm

This setting specifies the number of seconds to sound the Leash Mode beeps (three per second) when the handheld goes out of range. This is especially useful in instances where the reader might inadvertently have been placed in a bag or cart.

For this mode to be effective, the reader must be linked to the Base Station. If the reader is asleep or disconnected from the Base Station, there is no way for it to know where it is relative to the Base Station because communication is not active between the devices.



★ Leash Alarm = Disable



Leash Alarm = 1 Second



Leash Alarm = 2 Seconds



Leash Alarm = 3 Seconds



Leash Alarm (continued)



Leash Alarm = 4 Seconds



Leash Alarm = 5 Seconds



Leash Alarm = 10 Seconds



Leash Alarm = 25 Seconds



Leash Alarm = 30 Seconds





## CONFIGURATION UPDATES

### Automatic Configuration Update

When this feature is enabled, a reader and its linked Base Station can automatically ensure they stay in sync with regard to application hardware and/or configuration. See [page 295](#) for more information on this feature.



Automatic Configuration Update = Disable



★ Automatic Configuration Update = Enable

### Copy Configuration to Reader

Scan the following label to copy the current Base Station configuration to the reader. Use this method when the Auto Configuration Update feature is disabled and you want a one-time configuration update to be performed on the reader.



**NOTE: Do not scan an ENTER/EXIT PROGRAMMING MODE label in conjunction with this bar code.**



Copy Configuration to Reader

### Copy Configuration to Base Station

Scan the following label to copy the current reader configuration to the Base Station. Use this method when the Auto Configuration Update feature is disabled and you want a one-time configuration update to be performed on the Base Station.



**NOTE: Do not scan an ENTER/EXIT PROGRAMMING MODE label in conjunction with this bar code.**



Copy Configuration to Base Station



## BATCH FEATURES

### Batch Mode

This option specifies whether to store labels in the handheld while disconnected from the base. Options are as follows:

- Disabled — The handheld will not store/batch labels.
- Automatic — The handheld will store labels to RAM when the handheld goes out of range and is disconnected from the remote device.
- Manual — The handheld will always store labels to Flash memory. The user must manually send the stored labels to the remote device using a special "batch send" label.



★ Batch Mode = Disable



Batch Mode = Automatic



Batch Mode = Manual

### Send Batch

When the reader is configured in Manual Batch Mode, use the following bar code to initiate sending of labels stored in batch memory.



**NOTE: Do not scan an ENTER/EXIT PROGRAMMING MODE label in conjunction with this bar code.**



Send Batch



## Erase Batch Memory

When the reader is configured in Manual Batch Mode, use the following bar code to erase any labels stored in batch memory.



**NOTE: Do not scan an ENTER/EXIT PROGRAMMING MODE label in conjunction with this bar code.**



Erase Batch Memory

## RF Batch Mode Transmit Delay

Specifies the delay in 10 msec increments between transmitting labels stored in batch memory.



★ RF Batch Mode Transmit Delay = No Delay



RF Batch Mode Transmit Delay = 50 msec



RF Batch Mode Transmit Delay = 100 msec



RF Batch Mode Transmit Delay = 0.5 seconds



RF Batch Mode Transmit Delay = 1 second



RF Batch Mode Transmit Delay = 2.5 seconds



## DIRECT RADIO AUTOLINK

### Direct Radio Autolink

This feature enables/disables the ability to link a wireless handheld to a base station without scanning the Unlink label first.



★ Direct Radio Link = Unlink Label Required



Direct Radio Link = Automatic Unlinking



## RF ADDRESS STAMPING

These features allow configuration of source radio data inclusion.

### Source Radio Address Transmission

Enables/disables the ability of source radio address information to be transmitted to the host and, if so, at what position with respect to the label data. See [page 295](#) in “References” for detailed information and examples for setting this feature.



**NOTE: When included as a prefix, the source-radio ID is displayed after all label formatting has been applied. The 6 byte hex address is sent as 12 ASCII characters, i.e., an address of 00 06 66 00 1A ED will be sent as (shown in hex): 30 30 30 36 36 36 30 30 31 41 45 44**



★ Source Radio Address Transmission =  
Do Not Include



Source Radio Address Transmission = Prefix

### Source Radio Address Delimiter Character

This option specifies the delimiter character to be placed between the label data and radio address when address stamping is enabled.



**NOTE: This feature only applies if “Source Radio Address Transmission” on [page 255](#) is enabled.**



Set Source Radio Address Delimiter Character

To configure this feature, scan the ENTER/EXIT PROGRAMMING MODE bar code above, then the bar code at left followed by the digits from the Alphanumeric characters in [Appendix D, Keypad](#) representing your desired character(s). End by scanning the ENTER/EXIT bar code again.

Make a mistake? Scan the CANCEL bar code to abort and not save the entry string. You can then start again at the beginning.



CANCEL

★ Delimiter Character = 00 (no delimiter character)

---

# BLUETOOTH-ONLY FEATURES

The features in this section are valid only for Gryphon Bluetooth models.



**NOTE: Changing the configuration parameters described in this section may cause a temporary loss of the Bluetooth connection between the Reader and the remote device.**

## Bluetooth Security Level



**NOTE: This parameter applies when pairing the Reader with a third party Bluetooth device. It has no effect when linking the Reader to a Base station.**

Set this parameter according to the security requirements of the application scenario when the reader will be employed.

- Select Level 1 - lowest when the main application requirement is to avoid any user interaction (e.g. Passkey or PIN entry) during the pairing process. When using this setting, the resulting Bluetooth connection will be encrypted but not authenticated.
- Select Level 2 when encryption is required, authentication is not required, and minimal user interaction is desired. In this case the Host may ask the user to enter a 6-digit Bluetooth Passkey during the pairing process.
- Select Level 3 - highest when a secure connection to the Host is desired, with both encryption and authentication. In this case the Host will ask the user to enter a 6-digit Bluetooth Passkey or a Bluetooth PIN during the pairing process.

If the Host prompts the user to enter a Bluetooth Passkey or PIN code during the pairing process, please refer to "Bluetooth Passkey or PIN Code Entry Request" on page 25 to perform this task.



**NOTE: When device authentication takes place during the pairing process, by means of the passkey or PIN entry, the resulting Bluetooth link is protected from Man-In-The-Middle (MITM) malicious attacks.**



**NOTE: The actual behaviors of the Reader and of the Host system during the pairing process depend on the security settings of both devices involved, and on the input and output means available on each device to interface with the user.**

**This means that:**

- the user may be required to enter a BT Passkey during the pairing process even if the reader's BT Security Level is set to "Encryption required, authentication not required". This depends on the configuration of the Host system.
- when the reader's BT Security Level is set to "Encryption and authentication required", it may not be possible to connect to a Host system if the latter cannot support the Passkey Entry authentication procedure. In this case, try to set the reader's BT Security Level to "Encryption required, authentication not required" to establish the connection.



**NOTE: Changing the BT Security Level setting will unlink the Reader from the remote device.**



★ BT Security Level = Level 1 - lowest



BT Security Level = Level 2



BT Security Level = Level 3 - highest

## Bluetooth Radio Output Power

Set this parameter according to the desired radio range of the Reader:

- Class 1: max 100 meters
- Class 2: max 20 meters
- Class 3: max 5 meters

Reducing the maximum radio range can help extend the battery life of the Reader and reduce the interferences caused to nearby wireless devices that operate in the same 2.4 GHz frequency band.



★ Bluetooth Output Power = Class 1 (highest)



Bluetooth Output Power = Class 2



Bluetooth Output Power = Class 3 (lowest)



## Wi-Fi Channels Exclusion

In case the Reader operates in the same environment as 2.4 GHz Wi-Fi equipment, set this parameter to configure the strategy that the Reader should employ to minimize the interferences between Bluetooth and Wi-Fi wireless technologies.

- If the specific 802.11 standard or the frequency channels used by the Wi-Fi equipment are unknown, select Automatic to let the Reader use the Adaptive Frequency Hopping (AFH) feature of Bluetooth technology. With this setting, the Reader and the remote Bluetooth device may automatically detect the frequency channels affected by a significant level of interference, and avoid using these channels during Bluetooth data exchange.
- If the specific 802.11 standard and the frequency channels used by the Wi-Fi equipment are known, select the corresponding combination from the list of programming labels below or use the Datalogic Aladdin tool. With this setting, the Reader and the remote Bluetooth device avoid using the Bluetooth frequency channels that overlap with the already occupied Wi-Fi channels.

For example, if the co-located 2.4 GHz Wi-Fi equipment operates according to the 802.11g standard on channels n. 6 and n. 11, read the 802.11b/g ch.6 and 11 programming label.



**NOTE: The programming labels in the list below cover the most popular combinations of 802.11 standards and 2.4 GHz Wi-Fi channels. If the configuration command corresponding to your specific scenario is not listed, please contact Datalogic Technical Support for further configuration options.**



★ WiFi Ch. Exclusion = Automatic



WiFi Ch. Exclusion = 802.11b\_g ch.1



WiFi Ch. Exclusion = 802.11b\_g ch.2



WiFi Ch. Exclusion = 802.11b\_g ch.3





### Wi-Fi Channels Exclusion (continued)



WiFi Ch. Exclusion = 802.11b\_g ch.4



WiFi Ch. Exclusion = 802.11b\_g ch.5



WiFi Ch. Exclusion = 802.11b\_g ch.6



WiFi Ch. Exclusion = 802.11b\_g ch.7



WiFi Ch. Exclusion = 802.11b\_g ch.8



WiFi Ch. Exclusion = 802.11b\_g ch.9



WiFi Ch. Exclusion = 802.11b\_g ch.10



WiFi Ch. Exclusion = 802.11b\_g ch.11



### Wi-Fi Channels Exclusion (continued)



WiFi Ch. Exclusion = 802.11b\_g ch.12



WiFi Ch. Exclusion = 802.11b\_g ch.13



WiFi Ch. Exclusion = 802.11b\_g ch.14



WiFi Ch. Exclusion = 802.11b\_g ch.1 and 6



WiFi Ch. Exclusion = 802.11b\_g ch.1 and 11



WiFi Ch. Exclusion = 802.11b\_g ch.6 and 11



WiFi Ch. Exclusion = 802.11b\_g ch.1 and 6 and 11



WiFi Ch. Exclusion = 802.11b\_g ch.2 and 7



### Wi-Fi Channels Exclusion (continued)



WiFi Ch. Exclusion = 802.11b\_g ch.2 and 12



WiFi Ch. Exclusion = 802.11b\_g ch.7 and 12



WiFi Ch. Exclusion = 802.11b\_g ch.2 and 7 and 12



WiFi Ch. Exclusion = 802.11b\_g ch.3 and 8



WiFi Ch. Exclusion = 802.11b\_g ch.3 and 13



WiFi Ch. Exclusion = 802.11b\_g ch.8 and 13



WiFi Ch. Exclusion = 802.11b\_g ch.3 and 8 and 13



WiFi Ch. Exclusion = 802.11b\_g ch.4 and 9



### Wi-Fi Channels Exclusion (continued)



WiFi Ch. Exclusion = 802.11b\_g ch.4 and 14



WiFi Ch. Exclusion = 802.11b\_g ch.9 and 14



WiFi Ch. Exclusion = 802.11b\_g ch.4 and 9 and 14



WiFi Ch. Exclusion = 802.11b\_g ch.5 and 10



WiFi Ch. Exclusion = 802.11n ch.3



WiFi Ch. Exclusion = 802.11n ch.11



## BLUETOOTH HID FEATURES

Before connecting the Reader to a Bluetooth HID host device, the keyboard emulation used for label transmission can be configured using the parameters described in this section, plus the following parameters:

- "Setting Country Mode" on page 51
- "Encoding Type" on page 65
- "ALT Output Type" on page 72
- "Keyboard Numeric Keypad" on page 74
- "Keyboard Send Control Characters" on page 74

### Bluetooth HID Alt Mode

Enable/Disable the ability to correctly transmit a label to the host regardless of the Bluetooth HID Country Mode selected, when Bluetooth HID Profile is configured.

Read the configuration command label below for the HID Alt Mode feature.



★ HID Alt Mode = OFF



HID Alt Mode = ONF



## FEATURES FOR STAR MODELS ONLY

The features in this section are valid only for the Gryphon I GM450X Star model:

- "STAR Radio Protocol Timeout" on page 264
- "STAR Radio Transmit Mode" on page 265

### STAR Radio Protocol Timeout

This parameter sets the valid wait time before transmission between the handheld reader and Base Station is considered failed.

When setting this parameter, take into consideration the radio traffic (number of readers in the same area). The selectable range for this feature is from 02 to 25 seconds. See [page 296](#) in "References" for detailed information and examples for setting this feature.



Set Radio Protocol Timeout

To configure this feature, scan the ENTER/EXIT PROGRAMMING MODE bar code above, then the bar code at left followed by the digits from the Alphanumeric characters in [Appendix D, Keypad](#) representing your desired character(s). End by scanning the ENTER/EXIT bar code again.

Make a mistake? Scan the CANCEL bar code to abort and not save the entry string. You can then start again at the beginning.



CANCEL

★ Radio Protocol Timeout = 02 (2 seconds)



## STAR Radio Transmit Mode

Specifies the transmission protocol for Star communications.

Options are:

- ACK from base station to reader — signals a good transmission as soon as the Base Station receives a label
- ACK when sent to host — reader signals a good transmission as soon as the Base Station has sent the label to the host
- ACK from host — reader signals a good transmission as soon as the Base Station has sent the label to the host and host has replied with an acknowledge message.



★ STAR Radio Transmit Mode =  
ACK from Base Station



STAR Radio Transmit Mode = ACK When Sent to Host



STAR Radio Transmit Mode = ACK from Host



**NOTE: ACK from host works only for RS-232 or USB-COM interfaces with ACK/NACK disabled. If ACK from host is configured with any other interface conditions, it works like ACK when sent to host.**

**See “Message Formatting” on page 299. for details.**



**NOTE: The Base Station can receive a host message only if Host Commands Obey/Ignore (page 35) is set to Ignore.**



## STAR System Speed

By default, the Reader and the Base exchange data at high speed over the wireless communication channel. Reducing the speed from high to low, the radio range can be further extended. Moreover, when using low speed, the Reader can be configured to use the STAR Frequency Agility feature (see "STAR Frequency Agility" on page 267) also for the 433 MHz model (see Table 4 on page 268).

To change the STAR System Speed, follow this procedure:

1. link the Reader to the Base;
2. scan the ENTER/EXIT PROGRAMMING MODE bar code above; read either the "High speed" or "Low speed" programming label below to set the desired speed; end by scanning the ENTER/EXIT bar code again.
3. place the Reader into the Base.

The Reader and the Base will now be linked at the new programmed speed.

This feature can also be programmed using the Datalogic Aladdin tool:

1. set the STAR System Speed to "High speed" or "Low speed" through Aladdin;
2. place an unlinked Reader into the Base.

The Reader and the Base will link at the new programmed speed.



**NOTE: Gryphon Star 433 MHz models do not support all combinations of STAR System Speed and STAR Frequency Agility (see "STAR Frequency Agility" on page 267) configuration parameters. Please refer to Table 4 on page 268 for the allowed combinations.**



★ STAR System Speed = High Speed



STAR System Speed = Low Speed





## STAR Frequency Agility

In exceptionally noisy environments or in case of a high concentration of radio devices, the STAR system performance may be improved by enabling the STAR Frequency Agility feature. This feature changes the way the radio frequencies are used in a STAR communication system.

As in the case of the STAR System Speed, use the following procedure:

1. link the Reader to the Base;
2. scan the ENTER/EXIT PROGRAMMING MODE bar code above; read either the “Enable” or “Disable” programming label below to Enable or Disable the feature; end by scanning the ENTER/EXIT bar code again.
3. place the Reader into the Base.

The Reader and the Base will be linked and the new frequency handling strategy will be operational.



**NOTE: It is possible to configure the STAR system to use a fixed channel with different frequency from the default one. Please contact Datalogic Technical Support for information about this feature. Please refer to Table 4 on page 268 for valid combinations of this feature with the STAR System Speed configuration parameter.**



**NOTE: Gryphon Star 433 MHz models do not support all combinations of STAR Frequency Agility and STAR System Speed (see "STAR System Speed" on page 266) configuration parameters. Please refer to Table 4 on page 268 for the allowed combinations.**



★ STAR Frequency Agility = Disable  
(use default fixed channel)



STAR Frequency Agility = Enable

**Table 4 Supported combinations of STAR System Speed and STAR Frequency Agility configuration parameters**

<b>SYSTEM SPEED</b>	<b>FREQUENCY AGILITY</b>	<b>FIXED CHANNEL DIFFERENT FROM DEFAULT</b>
<b>433 MHz Model</b>		
Low Speed	Yes	Yes
High Speed	No	No
<b>910 MHz Model</b>		
Low Speed	Yes	Yes
High Speed	Yes	Yes

# CHAPTER 4

## REFERENCES

This section contains explanations and examples of selected bar code features. See [Configuration with Bar Codes](#), starting on page 33 for the actual bar code labels used to configure the reader.

### SECTION CONTENTS

#### **RS-232 PARAMETERS** on page 270

- Baud Rate
- Data Bits
- Stop Bits
- Parity
- Handshaking Control

#### **RS-232/USB COM PARAMETERS** on page 271

- Intercharacter Delay
- ACK NAK Options
- ACK Character
- NAK Character
- ACK NAK Timeout Value
- ACK NAK Retry Count
- Disable Character
- Enable Character

#### **KEYBOARD INTERFACE** on page 278

- Wedge Quiet Interval
- Intercharacter Delay
- Intercode Delay

#### **DATA FORMAT** on page 281

- Data Editing
- Global Prefix/Suffix
- Global AIM ID
- Label ID
- Character Conversion

#### **SCANNING FEATURES** on page 289

- Scan Mode
- Scanning Active Time
- Aiming Duration Time
- Flash On Time
- Flash Off Time

#### **LED AND BEEPER INDICATORS** on page 294

- Good Read LED Duration

#### **RF FEATURES** on page 295

- Automatic Configuration Update
- RF Address Stamping
- STAR Radio Protocol Timeout

#### **SYMBOLOGIES** on page 297

- Set Length

## RS-232 PARAMETERS

### RS-232 ONLY

#### Baud Rate

Baud rate is the number of bits of data transmitted per second. Set the reader's baud rate to match the baud rate setting of the host device. With an improper baud rate setting, data may not reach the host correctly.

#### Data Bits

This parameter allows the reader to interface with devices requiring a 7-bit or 8-bit ASCII protocol for sending and receiving data.

#### Stop Bits

The stop bit(s) at the end of each transmitted character marks the end of transmission of one character and prepares the receiving device for the next character in the serial data stream. The number of stop bits selected (one or two) depends on the number the receiving terminal is programmed to accommodate. Set the number of stop bits to match host device requirements.

#### Parity

This feature specifies parity required for sending and receiving data. A parity check bit is the most significant bit of each ASCII coded character. Select the parity type according to host device requirements.

- Select None when no parity bit is required.
- Select Odd parity and the parity bit value is set to 0 or 1, based on data, to ensure that an odd number of 1 bits are contained in the coded character.
- Select Even parity and the parity bit value is set to 0 or 1, based on data, to ensure that an even number of 1 bits are contained in the coded character.

#### Handshaking Control

The data interface consists of an RS-232 port designed to operate either with or without the hardware handshaking lines, Request to Send (RTS), and Clear to Send (CTS). Handshaking Control includes the following options:

- RTS — RTS is asserted during transmissions. CTS is ignored.
- RTS/CTS — RTS is asserted during transmissions. CTS gates transmissions.
- RTS/XON/XOFF — RTS is asserted during transmissions. CTS is ignored. XON and XOFF gate transmissions.
- RTS On/CTS — RTS is always asserted. CTS gates transmissions.
- RTS/CTS Scan Control — RTS is asserted during transmissions. CTS gates transmissions and controls enable and disable state of reader.

# RS-232/USB COM PARAMETERS

## Intercharacter Delay

This parameter specifies the intercharacter delay between the end of one character and the beginning of the next. The delay can be set within a range of zero (0) to 990 milliseconds in 10ms increments. A setting of zero specifies no delay.

To set the delay:

1. Determine the desired setting in milliseconds.
2. Divide the desired setting by 10 (setting is in 10ms increments). Pad the result with leading zeroes to yield two digits. For example: 0 = 00, 5 = 05, 20 = 20, etc.
3. Scan the ENTER/EXIT PROGRAMMING MODE bar code to enter Programming Mode.
4. Go to [page 42](#) and scan the bar code: SELECT INTERCHARACTER DELAY SETTING.
5. Scan the appropriate two digits from the keypad in [Appendix D](#), that represent the duration which was determined in the steps above. You will hear a two-beep indication after the last character.



**NOTE: If you make a mistake before the last character, scan the CANCEL bar code to abort and not save the entry string. You can then start again at the beginning.**

6. Scan the ENTER/EXIT PROGRAMMING MODE bar code to exit.

This completes the procedure. See the following table for examples of how to set this feature.

**Table 5 - Intercharacter Delay Setting Examples**

STEP	ACTION	EXAMPLES			
1	<b>Desired Setting</b>	50ms	150ms	600ms	850ms
2	<b>Divide by 10 (pad with leading zeroes to yield two-digits)</b>	05	10	60	85
3	<b>Scan ENTER/EXIT PROGRAMMING MODE</b>				
4	<b>Scan SELECT INTERCHARACTER DELAY SETTING</b>				
5	<b>Scan two characters from Appendix D</b>	'0' and '5'	'1' and '5'	'6' and '0'	'8' and '5'
6	<b>Scan ENTER/EXIT PROGRAMMING MODE</b>				

## ACK NAK Options

This enables/disables the ability of the reader to support the RS-232 ACK/NAK protocol. When configured, the reader and/or host sends an “ACK” when it receives data properly, and sends “NAK” when the data is in error.

Options are:

- Disable
- Enable for label transmission — The reader expects an ACK/NAK response from the host when a label is sent
- Enable for host-command acknowledge — The reader will respond with ACK/NAK when the host sends a command
- Enable for label transmission and host-command acknowledge

## ACK Character

This setting specifies an ASCII character or hex value to be used as the ACK character. ASCII characters or any hex value from 0 to 0xFF can be selected.



**NOTE: Setting to previously defined characters such as XON, XOFF, or host commands conflicts with normal operation of these characters. 8-bit data is not recognized when the option Data Bits page 45 has been set as 7 Data Bits.**

1. Determine the desired character or value.
2. Use the ASCII Chart on [page 347](#) to find the hex equivalent for the desired character/value.
3. Scan ENTER/EXIT PROGRAMMING MODE to enter Programming Mode.
4. Scan the bar code: SELECT ACK CHARACTER SETTING.
5. Scan the appropriate two alphanumeric characters from the keypad in [Appendix D](#), that represent the desired character/value determined above. The second character will cause a two-beep indication.
6. Scan the ENTER/EXIT PROGRAMMING MODE bar code to exit.

See the table below for examples of how to set this feature.

**Table 6 - ACK Character Setting Examples**

STEP	ACTION	EXAMPLES			
1	Desired Character/Value	ACK	\$	@	>
2	Hex equivalent from ASCII Chart on page 347	0x06	0x24	0x40	0x3E
3	Scan ENTER/EXIT PROGRAMMING MODE				
4	Scan SELECT ACK CHARACTER SETTING				
5	Scan two characters from Appendix D	'0' and '6'	'2' and '4'	'4' and '0'	'3' AND 'E'
6	Scan ENTER/EXIT PROGRAMMING MODE				

## NAK Character

This setting specifies an ASCII character or hex value to be used as the NAK character. ASCII characters or any hex value from 0 to 0xFF can be selected.



**NOTE: Setting to previously defined characters such as XON, XOFF, or host commands conflicts with normal operation of these characters. 8-bit data is not recognized when the option Data Bits on page 45 has been set as 7 Data Bits.**

To set this feature:

1. Determine the desired character or value.
2. Use the ASCII Chart on [page 347](#) to find the hex equivalent for the desired character/value.
3. Scan the ENTER/EXIT PROGRAMMING MODE bar code to enter Programming Mode.
4. Scan the bar code: SELECT NAK CHARACTER SETTING.
5. Scan the appropriate two alpha-numeric characters from the keypad in [Appendix D](#), that represent the desired character/value determined above. The second character will cause a two-beep indication.
6. Scan the ENTER/EXIT PROGRAMMING MODE bar code to exit Programming Mode.

This completes the procedure. See the table below for examples of how to set this feature.

**Table 7 - NAK Character Setting Examples**

STEP	ACTION	EXAMPLES			
1	Desired Character/Value	NAK	\$	@	>
2	Hex equivalent	0x15	0x24	0x40	0x3E
3	Scan ENTER/EXIT PROGRAMMING MODE				
4	Scan SELECT NAK CHARACTER SETTING				
5	Scan two characters from Appendix D	'1' and '5'	'2' and '4'	'4' and '0'	'3' AND 'E'
6	Scan ENTER/EXIT PROGRAMMING MODE				

## ACK NAK Timeout Value

This option specifies the amount of time the reader waits for an ACK character from the host following label transmission. The selectable timeout range is 200 milliseconds to 15,000ms (15 seconds) in 200ms increments. A selection of 0 disables the timeout.

To set this value:

1. Determine the desired setting in milliseconds.
2. Divide the desired setting by 200 (setting is in 200ms increments). Pad the result with leading zeroes to yield two digits. For example: 0 = 00, 5 = 05, 20 = 20, etc.
3. Scan the ENTER/EXIT PROGRAMMING MODE bar code to enter Programming Mode.
4. Scan the bar code: SELECT ACK NAK TIMEOUT VALUE SETTING.
5. Scan the appropriate two digits from the keypad in [Appendix D](#), that represent the duration which was determined in the steps above. You will hear a two-beep indication after the last character.



**NOTE: If you make a mistake before the last character, scan the CANCEL bar code to abort and not save the entry string. You can then start again at the beginning.**

6. Scan the ENTER/EXIT PROGRAMMING MODE bar code to exit Programming Mode. This completes the procedure. See the table below for examples of how to set this feature.

**Table 8 - ACK NAK Timeout Value Setting Examples**

STEP	ACTION	EXAMPLES			
1	<b>Desired Setting</b>	200ms	1,000ms (1 sec.)	5200ms (5.2 sec.)	15,000ms (15 sec.)
2	<b>Divide by 200</b>	01	05	26	75
3	<b>Scan ENTER/EXIT PROGRAMMING MODE</b>				
4	<b>Scan SELECT ACK NAK TIMEOUT VALUE SETTING</b>				
5	<b>Scan two characters from Appendix D</b>	'0' and '1'	'0' and '5'	'2' and '6'	'7' AND '5'
6	<b>Scan ENTER/EXIT PROGRAMMING MODE</b>				



## ACK NAK Retry Count

This feature specifies the number of times the reader retries a label transmission due to a retry condition. The selectable range is from 1 to 254 retries. A selection of 0 disables the count, and a selection of 255 specifies unlimited retries.

To set this feature:

1. Determine the desired setting.
2. Pad the number with leading zeroes to yield three digits. For example: 0 = 000, 5 = 005, 20 = 020, etc.
3. Scan the ENTER/EXIT PROGRAMMING MODE bar code to enter Programming Mode.
4. Scan the bar code: SELECT ACK NAK RETRY COUNT SETTING.
5. Scan the appropriate three digits from the keypad in [Appendix D](#), that represent the number which was determined in the steps above. You will hear a two-beep indication after the last character.



**NOTE: If you make a mistake before the last character, scan the CANCEL bar code to abort and not save the entry string. You can then start again at the beginning.**

6. Scan the ENTER/EXIT PROGRAMMING MODE bar code to exit Programming Mode.

This completes the procedure. See the table below for examples of how to set this feature.

**Table 9 - ACK NAK Retry Count Setting Examples**

STEP	ACTION	EXAMPLES			
1	<b>Desired Setting</b>	Disable Retry Count	3 Retries	54 Retries	Unlimited Retries
2	<b>Pad with leading zero(es)</b>	000	003	054	255
3	<b>Scan ENTER/EXIT PROGRAMMING MODE</b>				
4	<b>Scan SELECT ACK NAK RETRY COUNT SETTING</b>				
5	<b>Scan three characters from Appendix D</b>	'0', '0' and '0'	'0', '0' and '3'	'0', '5' and '4'	'2', '5' and '5'
6	<b>Scan ENTER/EXIT PROGRAMMING MODE</b>				

## Disable Character

Specifies the value of the RS-232 host command used to disable the reader.

ASCII characters or any hex value from 0 to 0xFF can be selected.



**NOTE: Setting to previously defined characters such as XON, XOFF, or host commands conflicts with normal operation of these characters. 8-bit data is not recognized when the option "Data Bits" on page 38 has been set as 7 Data Bits.**

To set the value:

1. Determine the desired character or value. A setting of 0xFF indicates the Disable Character is not used (not available).
2. Use the ASCII Chart on [page 347](#) to find the hex equivalent for the desired character/value.
3. Scan the ENTER/EXIT PROGRAMMING MODE bar code to enter Programming Mode.
4. Scan the bar code: SELECT DISABLE CHARACTER SETTING on [page 48](#).
5. Scan the appropriate two alphanumeric characters from the keypad in [Appendix D](#), that represent the desired character/value determined above. The second character will cause a two-beep indication.
6. Scan the ENTER/EXIT PROGRAMMING MODE bar code to exit Programming Mode.

This completes the procedure. See the table below for examples of how to set this feature.

**Table 10 -Disable Character Setting Examples**

STEP	ACTION	EXAMPLES			
1	Desired character/value	'd'	'}'	'D'	Disable Command Not Used
2	Hex equivalent from ASCII Chart on <a href="#">page 347</a>	0x64	0x7D	0x44	0xFF
3	Scan ENTER/EXIT PROGRAMMING MODE				
4	Scan SELECT DISABLE CHARACTER VALUE SETTING				
5	Scan three characters from <a href="#">Appendix D</a>	'6' and '4'	'7' and 'D'	'4' and '4'	'F' and 'F'
6	Scan ENTER/EXIT PROGRAMMING MODE				

## Enable Character

Specifies the value of the RS-232 host command used to enable the reader.

ASCII characters or any hex value from 0 to 0xFF can be selected.



**NOTE: Setting to previously defined characters such as XON, XOFF, or host commands conflicts with normal operation of these characters. 8-bit data is not recognized when the option "Data Bits" on page 38 has been set as 7 Data Bits.**

To set the value:

1. Determine the desired character or value. A setting of 0xFF indicates the Enable Character is not used (not available).
2. Use the ASCII Chart in [Appendix F](#) to find the hex equivalent for the desired character/value.
3. Scan the ENTER/EXIT PROGRAMMING MODE bar code to enter Programming Mode.
4. Scan the bar code: SELECT ENABLE CHARACTER SETTING on [page 48](#).
5. Scan the appropriate two alphanumeric characters from the keypad in [Appendix D](#), that represent the desired character/value determined above. The second character will cause a two-beep indication.
6. Scan the ENTER/EXIT PROGRAMMING MODE bar code to exit Programming Mode.

This completes the procedure. See the table below for examples of how to set this feature.

**Table 11 - Enable Character Setting Examples**

STEP	ACTION	EXAMPLES			
1	Desired character/value	'e'	'}	'E'	Enable Command Not Used
2	Hex equivalent from ASCII Chart on page 347	0x65	0x7D	0x45	0xFF
3	Scan ENTER/EXIT PROGRAMMING MODE				
4	Scan SELECT ENABLE CHARACTER VALUE SETTING				
5	Scan two characters from Appendix D	'6' and '5'	'7' and 'D'	'4' and '5'	'F' and 'F'
6	Scan ENTER/EXIT PROGRAMMING MODE				

# KEYBOARD INTERFACE

## Wedge Quiet Interval

Specifies the amount of time the reader looks for keyboard activity before it breaks the keyboard connection in order to transmit data to host. The range is from 0 to 990ms in 10ms increments.



**NOTE: This feature applies ONLY to the Keyboard Wedge interface.**

1. Determine the desired setting in milliseconds.
2. Divide the desired setting by 10 (setting is in 10ms increments). Pad the result with leading zeroes to yield two digits. For example: 0 = 00, 5 = 05, 20 = 20, etc.
3. Go to [page 75](#) and scan the ENTER/EXIT PROGRAMMING MODE bar code to enter Prog. Mode.
4. Scan the bar code: SELECT WEDGE QUIET INTERVAL SETTING on [page 75](#).
5. Scan the appropriate two digits from the keypad in [Appendix D](#), that represent the duration which was determined in the steps above. You will hear a two-beep indication after the last character.



**NOTE: If you make a mistake before the last character, scan the CANCEL bar code to abort and not save the entry string. You can then start again at the beginning.**

6. Scan the ENTER/EXIT PROGRAMMING MODE bar code to exit.

This completes the procedure to set the Wedge Quiet Interval. See the table below for examples of how to set this feature.

**Table 12 - Wedge Quiet Interval Setting Examples**

STEP	ACTION	EXAMPLES			
1	Desired Setting	10ms	150ms	600ms	850ms
2	Divide by 10 (and pad with leading zeroes)	01	15	60	85
3	Scan ENTER/EXIT PROGRAMMING MODE				
4	Scan SELECT WEDGE QUIET INTERVAL SETTING				
5	Scan two characters from Appendix D	'0' and '1'	'1' and '5'	'6' and '0'	'8' and '5'
6	Scan ENTER/EXIT PROGRAMMING MODE				

## Intercharacter Delay

This parameter specifies the intercharacter delay between the end of one character and the beginning of the next. The delay can be set within a range of zero (0) to 990 milliseconds in 10ms increments. A setting of zero specifies no delay.



**NOTE: This feature applies ONLY to the Keyboard Wedge interface.**

To set the delay:

1. Determine the desired setting in milliseconds.
2. Divide the desired setting by 10 (setting is in 10ms increments). Pad the result with leading zeroes to yield two digits. For example: 0 = 00, 5 = 05, 20 = 20, etc.
3. Go to [page 76](#) and scan the ENTER/EXIT PROGRAMMING MODE bar code to enter Programming Mode.
4. Scan the bar code: SELECT INTERCHARACTER DELAY SETTING on [page 76](#).
5. Scan the appropriate two digits from the keypad in [Appendix D](#), that represent the duration which was determined in the steps above. You will hear a two-beep indication after the last character.



**NOTE: If you make a mistake before the last character, scan the CANCEL bar code to abort and not save the entry string. You can then start again at the beginning.**

6. Scan the ENTER/EXIT PROGRAMMING MODE bar code to exit Programming Mode. This completes the procedure. See the table below for examples of how to set this feature.

**Table 13 - Intercharacter Delay Setting Examples**

STEP	ACTION	EXAMPLES			
1	Desired Setting	50ms	150ms	600ms	850ms
2	Divide by 10 (and pad with leading zeroes to yield two-digits)	05	15	60	85
3	Scan ENTER/EXIT PROGRAMMING MODE				
4	Scan SELECT INTERCHARACTER DELAY SETTING				
5	Scan two characters from Appendix D	'0' and '5'	'1' and '5'	'6' and '0'	'8' and '5'
6	Scan ENTER/EXIT PROGRAMMING MODE				

## Intercode Delay

Specifies the delay between labels transmitted to the host for this interface. The selectable range for this feature is from 0 to 99 seconds.

Follow these instructions to set this feature:

1. Determine the desired setting.
2. Pad the number with leading zeroes to yield two digits. For example: 0 = 00, 5 = 05, 20 = 20, etc
3. Go to [page 76](#) and scan the ENTER/EXIT PROGRAMMING MODE bar code to enter Programming Mode.
4. Scan the bar code: SELECT INTERCODE DELAY SETTING on [page 76](#).
5. Scan the appropriate two digits from the keypad in [Appendix D](#), that represent the duration which was determined in the steps above. You will hear a two-beep indication after the last character.



**NOTE: If you make a mistake before the last character, scan the CANCEL bar code to abort and not save the entry string. You can then start again at the beginning.**

6. Scan the ENTER/EXIT PROGRAMMING MODE bar code to exit Programming Mode. This completes the procedure. See the table below for examples of how to set this feature.

**Table 14 - Intercode Delay Setting Examples**

STEP	ACTION	EXAMPLES			
1	<b>Desired Setting</b>	No Delay	5 seconds	60 seconds	99 seconds
2	<b>Pad with leading zero(es)</b>	00	05	60	99
3	<b>Scan ENTER/EXIT PROGRAMMING MODE</b>				
4	<b>Scan SELECT INTERCODE DELAY SETTING</b>				
5	<b>Scan two characters from Appendix D</b>	'0' and '0'	'0' and '5'	'6' and '0'	'9' and '9'
6	<b>Scan ENTER/EXIT PROGRAMMING MODE</b>				

## DATA FORMAT

### Data Editing

When a bar code is scanned, additional information can be sent to the host computer along with the bar code data. This combination of bar code data and supplementary user-defined data is called a “message string.” The Data Editing features can be used to build specific user-defined data into a message string.

There are several types of selectable data characters that can be sent before and after scanned data. You can specify if they should be sent with all symbologies, or only with specific symbologies. The following shows the available elements you can add to a message string:

**Figure 21 - Breakdown of a Message String**

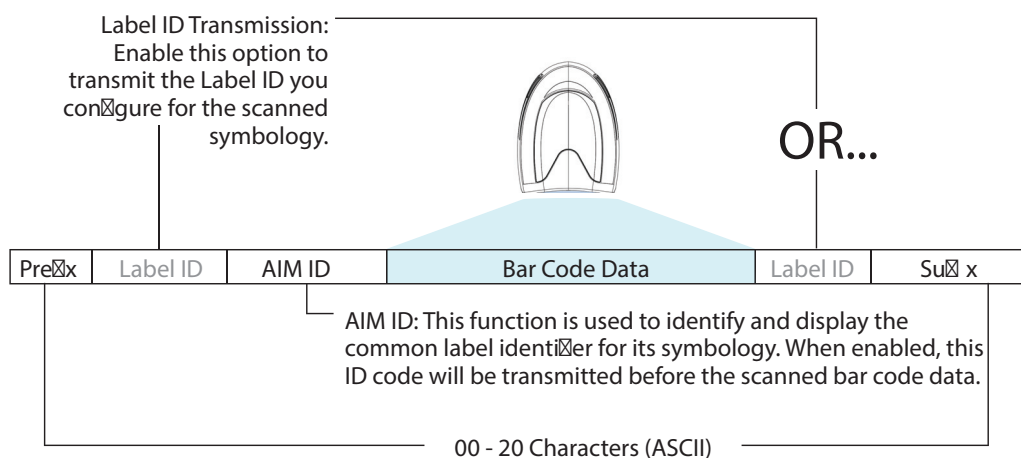

**NOTE: Additional advanced editing is available. See the Advanced formatting features in the Datalogic Aladdin configuration software, or contact "Technical Support" on page xiv for more information.**

### Please Keep In Mind...

- Modifying a message string is not a mandatory requirement. Data editing is a sophisticated feature allowing highly customizable output for advanced users. Factory default settings for data editing is typically set to NONE.
- A prefix or suffix may be applied only to a specified symbology (reference [1D Symbologies, starting on page 118](#)) or across all symbologies (set via the Global features in [Configuration with Bar Codes, starting on page 33](#)).
- You can add any character from the ASCII Chart on [page 347](#) (from 00-FF) on the inside back cover of this manual as a prefix, suffix or Label ID.
- Enter prefixes and suffixes in the order in which you want them to appear on the output.

## Global Prefix/Suffix

Up to 20 ASCII characters may be added as a prefix (in a position before the bar code data) and/or as a suffix (in a position following the bar code data) as indicated.

Figure 22 Prefix and Suffix Positions

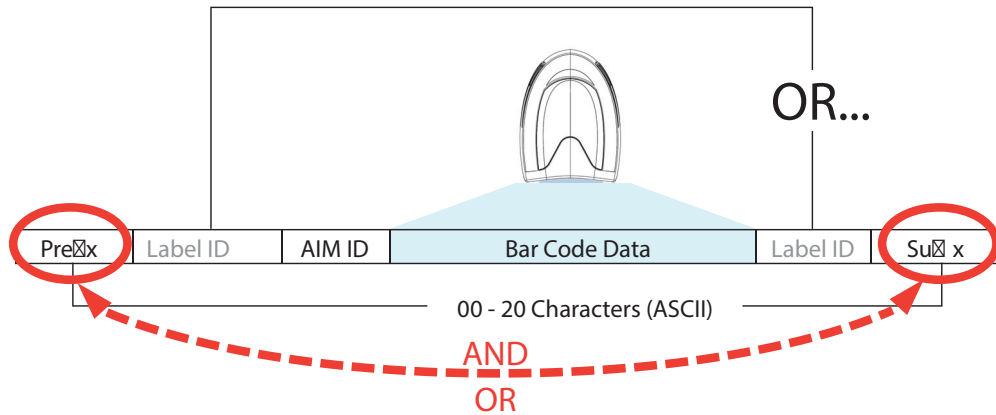

### Example: Setting a Prefix

In this example, we'll set a prefix for all symbologies.

1. Determine which ASCII character(s) are to be added to scanned bar code data. In this example, we'll add a dollar sign ('\$') as a prefix.
2. Scan the ENTER/EXIT PROGRAMMING MODE bar code, then scan the SET GLOBAL PREFIX bar code.
3. Reference the ASCII Chart on page 347 in Appendix F to find the hex value assigned to the desired character. The corresponding hex number for the '\$' character is 24. To enter this selection code, scan the '2' and '4' bar codes from Appendix D.



**NOTE: If you make a mistake before the last character, scan the CANCEL bar code to abort and not save the entry string. You can then start again at the beginning.**

4. If less than the expected string of 20 characters are selected, scan the ENTER/EXIT bar code to terminate the string.
5. Scan the ENTER/EXIT bar code once again to exit Programming Mode.

The resulting message string would appear as follows:

Scanned bar code data: **12345**

Resulting message string output: **\$12345**



## Global AIM ID



**NOTE:** This feature enables/disables addition of AIM IDs for all symbology types.

AIM label identifiers (as opposed to custom characters you select yourself as with label identifiers) can be included with scanned bar code data. AIM label identifiers consist of three characters as follows:

- A close brace character (ASCII '['), followed by...
- A code character (see the table below), followed by...
- A modifier character (the modifier character is symbol dependent).

SYMBOLGY	CHAR	SYMBOLGY	CHAR
UPC/EAN	E <sup>a</sup>	Code 128/GS1-128	C
Code 39 and Code 32	A	DataBar Omnidirectional, DataBar Expanded	e
Codabar	F	Standard 2 of 5	S
Interleaved 2 of 5	I	ISBN	X <sup>b</sup>
Code 93	G	Code 11	H

a. UPC-A and UPC-E labels are converted to EAN 13 when adding AIM IDs.

b. ISBN (X with a 0 modifier character)

**Figure 23** AIM ID

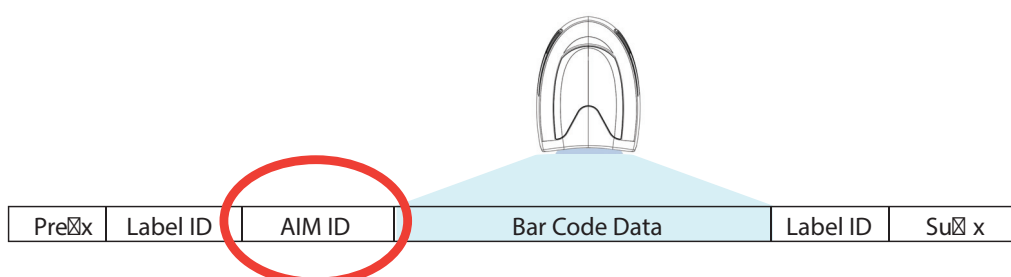

## Label ID

A Label ID is a customizable code of up to three ASCII characters (each can be one of hex 0x01-0xFF), used to identify a bar code (symbology) type. It can be appended previous to or following the transmitted bar code data depending upon how this option is enabled. This feature provides options for configuring custom Label IDs as a pre-loaded set or individually per symbology (see "[Label ID: Set Individually Per Symbology](#)" on page 87). If you wish to program the reader to always include an industry standard label identifier for ALL symbology types, see "[Global AIM ID](#)" on page 85.

### Label ID: Pre-loaded Sets

The following table lists the pre-loaded label ID sets for the USA and Europe.

**Table 15 - Label ID Pre-loaded Sets**

SYMBOLGY	USA LABEL ID SET		EU LABEL ID SET	
	ASCII character	Hex value	ASCII character	Hexadecimal value
ABC Codabar	S	530000	S	530000
CODABAR	%	250000	R	520000
Code 39 CIP HR	Y	590000	Y	590000
Code 93	&	260000	U	550000
Code 11	CE	434500	b	620000
Code 128	#	230000	T	540000
Code 32	A	410000	X	580000
Code 39	*	2A0000	V	560000
Datalogic 2of5	s	730000	s	730000
EAN13	F	460000	B	420000
EAN13 P2	F	460000	L	4C0000
EAN13 P5	F	460000	M	4D0000
EAN8	FF	464600	A	410000
EAN8 P2	FF	464600	J	4A0000
EAN8 P5	FF	464600	K	4B0000
FOLLETT 2OF5	O	4F0000	O	4F0000
GS1 DATABAR EXPANDED	RX	525800	t	740000
GS1 DATABAR LIMITED	RL	524C00	v	760000
GS1 DATABAR OMNIDIRECTIONAL	R4	523400	u	750000
GS1-128		000000	k	6B0000
I2OF5	i	690000	N	4E0000
IATA	IA	494100	&	260000
Industrial 2 of 5	W	570000	W	570000
Interleaved 2 of 5	e	650000	e	650000
ISBN	l	490000	@	400000
ISBT128	f	660000	f	660000

SYMBOLGY	USA LABEL ID SET		EU LABEL ID SET	
ISSN	n	6E0000	n	6E0000
MSI	@	400000	Z	5A0000
S25	s	730000	P	500000
UPCA	A	410000	C	430000
UPCA P2	A	410000	F	460000
UPCA P5	A	410000	G	470000
UPCE	E	450000	D	440000
UPCE P2	E	450000	H	480000
UPCE P5	E	450000	I	490000
OCR-A	o	6F0000	\$o	246F00
OCR-B	o	6F0000	\$p	247000
MICR	o	6F0000	\$m	246D00

## Label ID: Set Individually Per Symbology

To configure a Label ID individually for a single symbology:

1. Scan the ENTER/EXIT bar code.
2. Select Label ID position as either BEFORE (Enable as Prefix) or AFTER (Enable as suffix) by scanning the appropriate bar code in the section "Label ID Control" on page 87. Reference Figure 24 for Label ID positioning options if multiple identification features are enabled.
3. Scan a bar code to select the symbology for which you wish to configure a custom Label ID from the section "Label ID Symbology Selection" on page 88.
4. Determine the desired character(s) (you may choose up to three) which will represent the Label ID for the selected symbology.
5. Turn to the ASCII Chart on page 347 on the inside back cover of this manual and find the equivalent hex digits associated with your choice of Label ID. For example, if you wish to select an equal sign (=) as a Label ID, the chart indicates its associated hex characters as 3D. Turn to Keypad, in Appendix D, and scan the bar codes representing the hex characters determined. For the example given, the characters '3' and 'D' would be scanned. More examples of Label ID settings are provided in Table 16 on page 287.



**NOTE: If you make a mistake before the last character, scan the CANCEL bar code to abort and not save the entry string. You can then start again at the beginning.**

6. Scan the ENTER/EXIT bar code to exit Label ID entry.
  7. Scan the ENTER/EXIT bar code once again to exit Programming Mode.
- This completes the steps to configure a Label ID for a given symbology.

**Figure 24 Label ID Position Options**

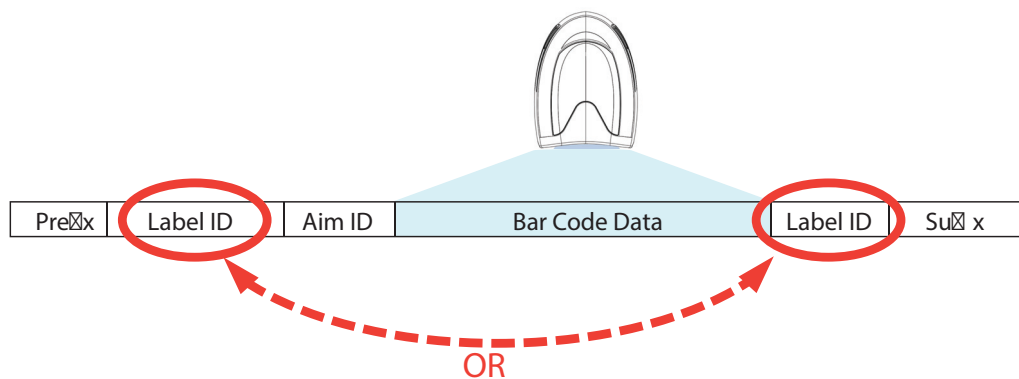

## Label ID: Set Individually Per Symbology — continued

Table 16 Label ID Examples

STEP	ACTION	EXAMPLES			
1	Scan the ENTER/EXIT bar code	(Reader enters Programming Mode)			
2	Determine placement of the Label ID characters BEFORE or AFTER with regard to scanned data using Label ID Control, starting on page 87	Enable as Prefix	Enable as Suffix	Enable as Prefix	Enable as Suffix
3	Scan the bar code selecting the symbology type you wish to designate label ID characters for using Label ID Symbology Selection, starting on page 88	GS1 DataBar Omnidirectional	Code 39	Interleaved 2 of 5	Code 32
4	Custom Label ID example (desired characters):	D B *	= C 3	+	PH
5	Find hex equivalents from the ASCII table (inside back cover), then scan in these digits/characters using the bar codes in the section: Keypad, starting on page 334. If you make a mistake before the last character, scan the CANCEL bar code to abort and not save the entry string. You can then start again at the beginning.	44 42 2A	3D 43 33	2B	50 48
6	Scan the ENTER/EXIT bar code	(Reader exits Label ID entry)			
7	Scan the ENTER/EXIT bar code once again	(Reader exits Programming Mode)			
<b>Result:</b>					
		DB*[bar code data]	[bar code data]=C3	+ [bar code data]	[bar code data]PH

## Character Conversion

Character conversion is an eight byte configuration item. The eight bytes are 4 character pairs represented in hexadecimal ASCII values. The first character in the pair is the character that will be converted. The second character in the pair is the character to convert to. If the character to convert in a pair is FF, then no conversion is done.

For example, if you have the character conversion configuration item set to the following: 41423132FFFFFFFF

The first pair is 4142 or AB (41 hex is an ASCII capital A, 42 hex is an ASCII capital B) and the second pair is 3132 or 12 (31 hex is an ASCII 1, 32 is an ASCII 2). The other two pairs are FFFF and FFFF.

With the label, AB12BA21, it would look as follows after the character conversion: BB22BB22.

The A characters were converted to B characters and the 1 characters were converted to 2 characters. Nothing is done with the last two character pairs, since they are all FF.

To set Character Conversion:

1. Scan the ENTER/EXIT bar code.
2. Scan the bar code for "[Character Conversion](#)" on [page 84](#)
3. Determine the desired string. Sixteen positions must be determined as in the above example. Next, turn to the ASCII Chart on [page 347](#) on the inside back cover of this manual and find the equivalent hex digits needed to fulfill the string.
4. Turn to [Appendix D](#), Keypad and scan the bar codes representing the hex characters determined in the previous step.
5. Scan the ENTER/EXIT bar code to exit Programming Mode.



**NOTE: If less than the expected string of 16 characters are selected, scan the ENTER/EXIT bar code twice to accept the selections and exit Programming Mode.**

# SCANNING FEATURES

## Scan Mode

Selects the scan operating mode for the reader. Selections are:

**Trigger Single:** When the trigger is pulled, scanning is activated until one of the following occurs:

- Stand Mode/Object Detection has elapsed
- a label has been read
- the trigger is released

This mode is associated with typical handheld reader operation: when the trigger is pulled, scanning starts and the product scans until the trigger is released, or a label is read, or the maximum Stand Mode/Object Detection has elapsed.

**Trigger Hold Multiple:** When the trigger is pulled, scanning starts and the product scans until the trigger is released or Stand Mode/Object Detection has elapsed. Reading a label does not disable scanning. **Double Read Timeout** prevents undesired multiple reads of the same label while in this mode.

**Trigger Pulse Multiple:** When the trigger is pulled, continuous scanning is activated until Stand Mode/Object Detection has elapsed or the trigger has been released and pulled again. **Double Read Timeout** prevents undesired multiple reads of the same label while in this mode.

**Flashing:** The reader flashes<sup>1</sup> on and off regardless of the trigger status. Flash rate is controlled by **Flash On Time** and **Flash Off Time**. When Flash is ON the reader reads continuously. When Flash is OFF scanning is deactivated.

**Always On:** No trigger pull is required to read a bar code. Scanning is continually on. **Double Read Timeout** prevents undesired multiple reads of the same label while in this mode.

**Stand Mode/Object Detection:** No trigger pull is required to read a bar code. Scanning turns on automatically when an item is placed in reader's field of view. While in a stand watch state, the reader illumination LED goes from dim to maximum bright.

---

1. Controlled by **Flash On Time**.

## Scanning Active Time

This setting specifies the amount of time that the reader stays in scan ON state once the state is entered. The range for this setting is from 1 to 255 seconds in 1-second increments.

Follow these instructions to set this feature:

1. Determine the desired setting.
2. Pad the result with leading zeroes to yield three digits. For example: 0 = 000, 5 = 005, 20 = 020, etc.
3. Scan the ENTER/EXIT PROGRAMMING MODE bar code to enter Programming Mode.
4. Scan the bar code: SELECT SCANNING ACTIVE TIME SETTING on [page 95](#).
5. Scan the appropriate three digits from the keypad in [Appendix D](#), that represent the duration which was determined in the steps above. You will hear a two-beep indication after the last character.



**NOTE: If you make a mistake before the last character, scan the CANCEL bar code to abort and not save the entry string. You can then start again at the beginning.**

6. Scan the ENTER/EXIT PROGRAMMING MODE bar code to exit Programming Mode. This completes the procedure. See the table below for examples of how to set this feature.

**Table 17 Scanning Active Time Setting Examples**

STEP	ACTION	EXAMPLES			
1	Desired Setting	1 Second	90 Sec. (1.5 min.)	180 Sec. (3 min.)	255 Seconds (4.25 min.)
2	Pad leading zero(es)	001	090	180	255
3	Scan ENTER/EXIT PROGRAMMING MODE				
4	Scan SELECT SCANNING ACTIVE TIME SETTING				
5	Scan three characters from Appendix D	'0', '0' and '1'	'0', '9' and '0'	'1', '8' and '0'	'2', '5' and '5'
6	Scan ENTER/EXIT PROGRAMMING MODE				



## Aiming Duration Time

Specifies the frame of time the aiming pointer remains on after decoding a label, when in trigger single mode. The range for this setting is from 1 to 255 seconds in 1-second increments.

Follow these instructions to set this feature:

1. Determine the desired setting.
2. Pad the result with leading zeroes to yield three digits. For example: 0 = 000, 5 = 005, 20 = 020, etc.
3. Scan the ENTER/EXIT PROGRAMMING MODE bar code to enter Programming Mode.
4. Scan the bar code: SELECT AIMING DURATION TIME SETTING.
5. Scan the appropriate two digits from the keypad in [Appendix D](#), that represent the duration which was determined in the steps above. You will hear a two-beep indication after the last character.



**NOTE: If you make a mistake before the last character, scan the CANCEL bar code to abort and not save the entry string. You can then start again at the beginning.**

6. Scan the ENTER/EXIT PROGRAMMING MODE bar code to exit Programming Mode.

This completes the procedure. See the following table for some examples of how to set this feature.

**Table 18 Aiming Duration Time Setting Examples**

STEP	ACTION	EXAMPLES			
1	<b>Desired Setting</b>	1 Second	90 Sec. (1.5 min.)	180 Sec. (3 min.)	255 Seconds (4.25 min.)
2	<b>Pad leading zero(es)</b>	001	090	180	255
3	<b>Scan ENTER/EXIT PROGRAMMING MODE</b>				
4	<b>Scan SELECT AIMING DURATION TIME SETTING</b>				
5	<b>Scan three characters from Appendix D</b>	'0', '0' and '1'	'0', '9' and '0'	'1', '8' and '0'	'2', '5' and '5'
6	<b>Scan ENTER/EXIT PROGRAMMING MODE</b>				

## Flash On Time

This feature specifies the ON time for the indicator LED while in Flash Mode. The selectable range is 100 to 9,900 milliseconds (0.1 to 9.9 seconds), in 100 millisecond increments.

Follow these instructions to set this feature.

1. Determine the desired setting in milliseconds.
2. Divide the desired setting by 100 (setting is in 100ms increments). Pad the result with leading zeroes to yield two digits. For example: 0 = 00, 5 = 05, 20 = 20, etc.
3. Scan the ENTER/EXIT PROGRAMMING MODE bar code to enter Programming Mode.
4. Scan the bar code: SELECT FLASH ON TIME SETTING on [page 95](#).
5. Scan the appropriate two digits from the keypad in [Appendix D](#), that represent the duration which was determined in the steps above. You will hear a two-beep indication after the last character.



**NOTE: If you make a mistake before the last character, scan the CANCEL bar code to abort and not save the entry string. You can then start again at the beginning.**

6. Scan the ENTER/EXIT PROGRAMMING MODE bar code to exit Programming Mode. This completes the procedure. See the following table for examples of how to set this feature.

**Table 19 Flash On Time Setting Examples**

STEP	ACTION	EXAMPLES			
1	Desired Setting	500ms	1,000ms (1 sec.)	5200ms (5.2 sec.)	9,900ms (9.9 sec.)
2	Divide by 100 (and pad with leading zeroes to yield two digits)	05	10	52	99
3	Scan ENTER/EXIT PROGRAMMING MODE				
4	Scan SELECT FLASH ON TIME SETTING				
5	Scan two characters from Appendix D	'0' and '5'	'1' and '0'	'5' and '2'	'9' and '9'
6	Scan ENTER/EXIT PROGRAMMING MODE				

## Flash Off Time

This feature specifies the OFF time for the indicator LED while in Flash Mode. The selectable range is 100 to 9,900 milliseconds (0.1 to 9.9 seconds), in 100 millisecond increments.

Follow these instructions to set this feature.

1. Determine the desired setting in milliseconds.
2. Divide the desired setting by 100 (setting is in 100ms increments). Pad the result with leading zeroes to yield two digits. For example: 0 = 00, 5 = 05, 20 = 20, etc.
3. Scan the ENTER/EXIT PROGRAMMING MODE bar code to enter Programming Mode.
4. Scan the bar code: SELECT FLASH OFF TIME SETTING on [page 96](#).
5. Scan the appropriate two digits from the keypad in [Appendix D](#), that represent the duration which was determined in the steps above. You will hear a two-beep indication after the last character.



**NOTE: If you make a mistake before the last character, scan the CANCEL bar code to abort and not save the entry string. You can then start again at the beginning.**

6. Scan the ENTER/EXIT PROGRAMMING MODE bar code to exit Programming Mode.

This completes the procedure. See the following table for examples of how to set this feature.

**Table 20 Flash Off Time Setting Examples**

STEP	ACTION	EXAMPLES			
1	<b>Desired Setting</b>	500ms	1,000ms (1 sec.)	5200ms (5.2 sec.)	9,900ms (9.9 sec.)
2	<b>Divide by 100 (and pad with leading zeroes to yield two digits)</b>	05	10	52	99
3	<b>Scan ENTER/EXIT PROGRAMMING MODE</b>				
4	<b>Scan SELECT FLASH OFF TIME SETTING</b>				
5	<b>Scan two characters from Appendix D</b>	'0' and '5'	'1' and '0'	'5' and '2'	'9' and '9'
6	<b>Scan ENTER/EXIT PROGRAMMING MODE</b>				

# LED AND BEEPER INDICATORS

## Good Read LED Duration

This feature specifies the amount of time that the Good Read LED remains on following a good read. The good read LED on time can be set within a range of 10 milliseconds to 2,550 milliseconds (0.001 to 2.55 seconds) in 100ms increments.

Follow these instructions to set this feature:

1. Determine the desired setting in milliseconds. A setting of 0 means that the good read LED stays on until the next time the trigger is pulled.
2. Divide the desired setting by 10 (setting is in 100ms increments). Pad the result with leading zeroes to yield three digits. For example: 0 = 000, 5 = 000, 20 = 020, etc.
3. Go to [page 109](#) and scan the ENTER/EXIT PROGRAMMING MODE bar code to enter Programming Mode.
4. Scan the bar code: SELECT GOOD READ LED DURATION SETTING.
5. Scan the appropriate two digits from the keypad in [Appendix D](#), that represent the duration which was determined in the steps above. You will hear a two-beep indication after the last character.



**NOTE: If you make a mistake before the last character, scan the CANCEL bar code to abort and not save the entry string. You can then start again at the beginning.**

6. Scan the ENTER/EXIT PROGRAMMING MODE bar code to exit Programming Mode. This completes the procedure. See the following table for some examples of how to set this feature.

**Table 21 Good Read LED Duration Setting Example**

STEP	ACTION	EXAMPLES			
1	<b>Desired Setting</b>	Good Read LED stays on until next trigger pull (00)	20ms	150ms	2550ms (2.55 sec.)
2	<b>Divide by 10 (and pad with leading zeroes)</b>	000	002	015	255
3	<b>Scan ENTER/EXIT PROGRAMMING MODE</b>				
4	<b>Scan SELECT GOOD READ LED DURATION SETTING</b>				
5	<b>Scan three characters from Appendix D</b>	'0', '0' and '0'	'0', '0' and '2'	'0', '1' and '5'	'2', '5' and '5'
6	<b>Scan ENTER/EXIT PROGRAMMING MODE</b>				

## RF FEATURES

### Automatic Configuration Update

When this feature is enabled, the base station and reader will keep their configurations synchronized. If a reader's configuration is altered by reading programming labels, this change is automatically transferred and updated in a linked base station. Likewise, if the base station's configuration is changed using Aladdin or by host commands, then the reader's configuration will automatically be updated if this feature is enabled.

### RF Address Stamping

#### Source Radio Address Delimiter Character

This option specifies the delimiter character to be placed between the label data and radio address when address stamping is enabled.



**NOTE: This feature only applies if "Source Radio Address Transmission" on page 255 is enabled**

Follow these instructions to select the delimiter character:

1. Determine the desired character, then find its hexadecimal equivalent on the ASCII Chart on [page 347](#). A setting of 00 specifies no delimiter character.
2. Scan the ENTER/EXIT PROGRAMMING MODE bar code to enter Programming Mode.
3. Scan the bar code: SET SOURCE RADIO ADDRESS DELIMITER CHARACTER.
4. Scan the appropriate two digits from the keypad in [Appendix D](#), that represent the hexadecimal characters which were determined in the steps above. You will hear a two-beep indication after the last character.



**NOTE: If you make a mistake before the last character, scan the CANCEL bar code to abort and not save the entry string. You can then start again at the beginning.**

5. Scan the ENTER/EXIT PROGRAMMING MODE bar code to exit.

**Table 22 Source Radio Address Delimiter Character Setting Examples**

STEP	ACTION	EXAMPLES			
1	Desired Setting	No delimiter character	, (comma)	- (dash)	/ (slash)
2	Scan ENTER/EXIT PROGRAMMING MODE				
3	Scan SET SOURCE RADIO ADDRESS DELIMITER CHARACTER				
4	Scan Two Characters From Appendix D	'0' and '0'	'2' and 'C'	'2' and 'D'	'2' AND 'F'
5	Scan ENTER/EXIT PROGRAMMING MODE				

## STAR Radio Protocol Timeout

This parameter sets the valid wait time before transmission between the handheld reader and Base Station is considered failed.

When setting this parameter, take into consideration the radio traffic (number of readers in the same area). The selectable range for this feature is from 02 to 25 seconds.

Follow these instructions to set this feature:

1. Determine the desired setting.
2. Pad the number with leading zeroes to yield two digits. For example: 2 = 02, 5 = 05, 25 = 25, etc
3. Scan the ENTER/EXIT PROGRAMMING MODE barcode to enter Programming Mode.
4. Scan the barcode: SELECT RADIO PROTOCOL TIMEOUT.
5. Scan the appropriate two digits from the keypad in [Appendix D](#), that represent the duration which was determined in the steps above. You will hear a two-beep indication after the last character.



**NOTE: If you make a mistake before the last character, scan the CANCEL bar code to abort and not save the entry string. You can then start again at the beginning.**

6. Scan the ENTER/EXIT PROGRAMMING MODE barcode to exit Programming Mode. This completes the procedure. See following table for some examples of how to set this feature.

**Table 23 STAR Radio Protocol Timeout Examples**

STEP	ACTION	EXAMPLES			
1	Desired Setting	2 Seconds	5 Seconds	10 Seconds	25 Seconds
2	Pad with leading zero(es)	2	5	10	25
3	Scan ENTER/EXIT PROGRAMMING MODE				
4	Scan SELECTSTAR RADIO PROTOCOL TIMEOUT SETTING				
5	Scan two characters from Appendix D	'0' and '2'	'0' and '5'	'1' and '0'	'2' AND '5'
5	Scan ENTER/EXIT PROGRAMMING MODE				

# SYMBOLOGIES

## Set Length

Length Control allows you to select either variable length decoding or fixed length decoding for the specified symbology.

**Variable Length:** For variable length decoding, a minimum and maximum length may be set.

**Fixed Length:** For fixed length decoding, two different lengths may be set.

### Set Length 1

This feature specifies one of the bar code lengths for a given symbology. Length 1 is the minimum label length if in Variable Length Mode, or the first fixed length if in Fixed Length Mode.

Reference the [1D Symbologies, starting on page 118](#) to view the selectable range (number of characters) for the symbology being set.

Follow these instructions to set this feature:

1. Determine the desired character length. Pad the number with leading zeroes to yield two digits. For example: 0 = 00, 5 = 05, 20 = 20, etc.
2. Scan the ENTER/EXIT PROGRAMMING MODE bar code to enter Programming Mode.
3. Scan the "Select Length 1 Setting" for the symbology being set.
4. Scan the appropriate two digits from the keypad in [Appendix D](#), that represent the length setting which was determined in the steps above. You will hear a two-beep indication after the last character.



**NOTE: If you make a mistake before the last character, scan the CANCEL bar code to abort and not save the entry string. You can then start again at the beginning.**

5. Scan the ENTER/EXIT PROGRAMMING MODE bar code to exit Programming Mode.

This completes the procedure. See the following table for examples of how to set this feature.

**Table 24 Length 1 Setting Examples**

STEP	ACTION	EXAMPLES			
1	<b>Desired Setting</b>	01 Character	07 Character	52 Character	74 Character
2	<b>Scan ENTER/EXIT PROGRAMMING MODE</b>				
3	<b>Scan SELECT LENGTH 1 SETTING for the desired symbology</b>				
4	<b>Scan two characters from Appendix D</b>	'0' and '1'	'0' and '7'	'5' and '2'	'7' AND '4'
5	<b>Scan ENTER/EXIT PROGRAMMING MODE</b>				

## Set Length 2

This feature specifies one of the bar code lengths for a given symbology. Length 2 is the maximum label length if in Variable Length Mode, or the second fixed length if in Fixed Length Mode.

Reference the [1D Symbologies, starting on page 118](#) to view the selectable range (number of characters) for the symbology being set. A setting of 00 specifies to ignore this length (only one fixed length).

Follow these instructions to set this feature:

1. Determine the desired character length. Pad the number with leading zeroes to yield two digits. For example: 0 = 00, 5 = 05, 20 = 20, etc.
2. Scan the ENTER/EXIT PROGRAMMING MODE bar code to enter Programming Mode.
3. Scan the “Select Length 2 Setting” for the symbology being set.
4. Scan the appropriate two digits from the keypad in [Appendix D](#), that represent the length setting which was determined in the steps above. You will hear a two-beep indication after the last character.



**NOTE: If you make a mistake before the last character, scan the CANCEL bar code to abort and not save the entry string. You can then start again at the beginning.**

5. Scan the ENTER/EXIT PROGRAMMING MODE bar code to exit Programming Mode.

This completes the procedure. See the following table for examples of how to set this feature.

**Table 25 Length 2 Setting Examples**

STEP	ACTION	EXAMPLES			
1	<b>Desired Setting</b>	00 (ignore second length)	07 Character	52 Character	74 Character
2	<b>Scan ENTER/EXIT PROGRAMMING MODE</b>				
3	<b>Scan SELECT LENGTH 2 SETTING</b>				
4	<b>Scan two characters from Appendix D</b>	'0' and '0'	'0' and '7'	'5' and '2'	'7' AND '4'
5	<b>Scan ENTER/EXIT PROGRAMMING MODE</b>				



# CHAPTER 5

## MESSAGE FORMATTING

---

### MESSAGE FORMATTING



**NOTE: Message Formatting is available for GM4500 models only.**

A message from the Host to the base must follow these rules:

- If Address stamping options or address delimiter are enabled on the base, the Host replay must have address field and delimiter too. Otherwise the message will be ignored. Address delimiter is present only when address stamping is enabled.
- Address stamping is necessary to correctly route the message to the Gryphon I, especially when more than one handheld is linked to the same base. Address stamping could be disabled if the system is in point to point configuration. If address stamping is not enabled, the messages are addressed to the first handheld linked to the base.
- The maximum character length for messages is 48.
- Messages end with "CR" 0x0D ASCII character. The CR character cannot be contained in the middle.
- Messages cannot start with '\$' or # because these are reserved for Service mode command
- Base station can receive host message only if Host Commands Obey/Ignore is set to Ignore.
- Message could be sent to the HH in response to a Label when "Transmit mode" require Ack from Host (see transmit mode parameter) or at any time. When messages are sent not in response to a label must start with DC2 0x12 ASCII character and could be sent in any transmit mode setting.
- Message could be sent to all HH linked to base by using a Multicast message: "00 00 00 00 2A AA"
- In order to receive a message, handhelds must not be in sleep state.
- If you want to control the reader's beeper from the host, you will also probably want to disable the good transmission beep that is emitted when the code is received from the base station. (See "[Wireless Features](#)" on page 245).
- The message field can store plain text and escape sequences. Escape sequences are interpreted as commands.

The format of the ACK from Host message (used for transmission mode 02) is:

**[Scanner\_Addr] [Scanner\_Addr\_delimiter] MESSAGE <CR>**

The format of a generic message From Host to HH is:

**[Scanner\_Addr] [Scanner\_Addr\_delimiter] DC2 MESSAGE <CR>**

where DC2 is ASCII 0x12 (^R) character.

[Items in square brackets are optional.]

## LED AND BEEPER CONTROL

The LED control escape sequences are intended to activate the LEDs for short periods of time and can be used in combination with the Beeper. The LED and Beeper will be controlled by the system after the entire command sequence is interpreted.

ESC SEQUENCE	ACTION
Esc [ 0 q	Emit short High tone + short delay
Esc [ 1 q	Emit short Low tone + short delay
Esc [ 2 q	Emit long Low tone + short delay
Esc [ 3 q	Emit good read tone
Esc [ 4 q	Emit bad tx tone
Esc [ 5 q	Wait 100 msec
Esc [ 6 q	Turn on the green LED
Esc [ 7 q	Turn off the green LED
Esc [ 8 q	Turn on the green spot
Esc [ 9 q	Turn off the green spot
Esc [ 0 r	Beep for Find me function (new)
Esc [ 1 r	Power-off (new)

**Example:**

Esc [ 6 q Esc [ 3 q Esc [ 7 q	Turns on the green LED, emits a good read tone, and turns off the green LED.
Esc [ 6 q Esc [ 5 q Esc [ 7 q	Turns on the green LED for 100 msec and then turns off the green LED.

Escape sequences different from those listed will be ignored.

# APPENDIX A

## TECHNICAL SPECIFICATIONS

The table below contains Physical and Performance Characteristics, User Environment and Regulatory information. Table 33 provides Standard Cable Pinouts.

### GD4500 TECHNICAL SPECIFICATIONS

Table 26 GD4500 Technical Specifications

ELECTRICAL CHARACTERISTICS	
Power Supply	GD4520: 5 VDC GD4590: 4.5 - 14.0 VDC
Consumption	Operating (Typical): <400 mA @ 5V, <200 mA @ 12V Standby/Idle (Typical): <90 mA @ 5V, <50 mA @ 12V
Max. Scan Rate	50 frames/sec
Reading Indicators	Top and rear illumination, Good Read Spot, Beep
OPTICAL CHARACTERISTICS	
Optical Format	1/4"
Active Imager Size	3896 um (H) x 2453 um (V)
Active Pixels	1280 H x 800 V
Illumination System	LED source Warm White Emission (wavelength = 350 - 770 nm) Hyper Red Emission (wavelength = 660 nm, DGM model only) IEC 62471 Exempt Risk Group
Ambient Light Up to	100,000 lux
Tilt Tolerance <sup>a</sup>	0° - 360°
Pitch Tolerance <sup>a</sup>	+/- 65°
Skew Tolerance <sup>a</sup>	+/- 65°
Field of View <sup>a</sup>	36° H x 23° V
PCS (Datalogic Test Chart)	minimum 15%

ENVIRONMENTAL CHARACTERISTICS	
<b>Operating Temperature</b>	0 °C to + 50 °C (+32° F to +122 °F)
<b>Storage Temperature</b>	-40 °C to + 70 °C (-40 ° F to +158 °F)
<b>Humidity</b>	95% non condensing
<b>Drop Resistance</b>	IEC 68-2-32 Tested 1.8 m (6 ft)
<b>ESD Protection</b>	16 KV
<b>Protection Class</b>	IP52
<b>Cable Length</b>	Refer to <a href="http://www.datalogic.com">www.datalogic.com</a>
PHYSICAL CHARACTERISTICS	
<b>Color</b>	Black White
<b>Dimensions</b>	Gun only (L/H/W): 10.9 x 16.6 x 6.8 cm (4.3" x 6.5" x 2.7") In Stand: (L/H/W): 7.5 x 21 x 10.9 cm (2.9" x 8.2" x 4.2")
<b>Weight (without cable)</b>	Approx. 161 g (5.7 oz.) GD4500 with integrated stand approx. 374 g (13.2 oz.)

a. Based on ISO 15423 specifications

# GBT/GM4500 TECHNICAL SPECIFICATIONS

Table 27 GBT/GM4500 Technical Specifications

ELECTRICAL CHARACTERISTICS	
Power Supply	GBT/GM4500: 5V to 14V +/-5% in the Communication Port 5V to 14V +/-5% in the Aux Power Port <b>NOTE:</b> Aux Power Port is recommended when long cables are connected to Communication Port.
Consumption (Typical)	Gun Only: 330 mA @ 3,7V (operative) base station Only: 80 mA @ 5V (operative) base station with Gun in Charge (scan while charging): 475 mA (PC host USB) 1150 mA (5V on Aux Power Port) 520 mA (12V on Aux Power Port) Gun Charging via micro USB: 480 mA (PC host port, no scan) 900 mA (wall adapter, no scan) 1160 mA (wall adapter, scan while charging)
Reading Indicators	Top and rear illumination, Good Read Spot, Beep, Vibration
Battery Capacity	Li-Ion 3.6V, 3250 mAh (11.7W/h)
Recharge Time (Typical)	Values valid for a fully depleted battery USB Only: 11h (no Scan) 15h (Scan while Charging) Using Aux Power Port: 3h (no Scan) 3.5h (Scan while Charging) Using micro USB (wall adapter): 2h (no Scan, with Wall Adapter) 4.6h (no Scan, with PC Host)
OPTICAL CHARACTERISTICS	
Optical Format	1/4"
Active Imager Size	3896 um (H) x 2453 um (V)
Active Pixels	1280 H x 800 V
Illumination System	LED source Warm White Emission (wavelength = 350 - 770 nm) Hyper Red Emission (wavelength = 660 nm, DGM model only) IEC 62471 Exempt Risk Group
Ambient Light Up to	100,000 lux
Tilt Tolerance <sup>a</sup>	0° - 360°
Pitch Tolerance <sup>a</sup>	+/- 65°

OPTICAL CHARACTERISTICS	
Skew Tolerance <sup>a</sup>	+/- 65°
Field of View <sup>a</sup>	36° H x 23° V
PCS (Datalogic Test Chart)	minimum 15%
ENVIRONMENTAL CHARACTERISTICS	
Operating Temperature	0 °C to + 50 °C (+32° F to +122 °F)
Storage Temperature	-40 °C to + 70 °C (-40 ° F to +158 °F)
Humidity	95% non condensing
Drop Resistance	IEC 68-2-32 Tested 1.8 m (6 ft)
ESD Protection	16 KV
Protection Class	IP52
Cable Length	Refer to <a href="http://www.datalogic.com">www.datalogic.com</a>
PHYSICAL CHARACTERISTICS	
Color	Black White
Dimensions	Gun only (L/H/W): 10.9 x 16.6 x 6.8 cm (4.3" x 6.5" x 2.7") Cradle only (L/H/W): 21.3 x 12.9 x 9.5 cm (8.4" x 5.1" x 3.7") Gun on cradle horizontal mount (L/H/W): 21.8 x 13.4 x 9.5 cm (8.4" x 5.3" x 3.7") Gun on cradle presentation mount (L/H/W): 18.4 x 17.1 x 9.5 cm (7.2" x 6.7" x 3.7")
Weight	Approx. 235 g (8.29 oz.) gun and battery pack included Battery Pack is approx. 65 g (2.29 oz.)

a. Based on ISO 15423 specifications

RADIO CHARACTERISTICS			
Wireless Technology	Star™ 910 MHz	Star™ 433 MHz	Bluetooth
Range (in open air)	50 m	50 m	100 m
Max number of devices per base station	16		7

# COMMON READING CHARACTERISTICS

Table 28 Reading Characteristics

READING CHARACTERISTICS		
	SR	HD
DOF <sup>a</sup>	Code 39 5 mils: 7.0 to 38.0 cm / 2.7 to 14.9 inch	Code 39 3 mils: 5.0 to 15.0 cm / 2.0 to 5.9 inch
	Code 39 10 mils: 2.2 to 58 cm / 0.8 to 22.8 inch	Code 39 5 mils: 0.5 to 25.0 cm / 0.2 to 9.8 inch
	Code 39 20 mils: FOV lim. - 110 cm / up to 43.3 inch	Code 39 10 mils: 0.5 to 45 cm / 0.2 to 17.7 inch
	EAN/UPC 7.5 mils: 9.0 - 30.0 cm / 3.5 to 11.8 inch	EAN/UPC 7.5 mils: 2.0 - 23.5 cm / 0.8 to 9.2 inch
	EAN/UPC 13 mils: 1.0 - 71.0 cm / 0.4 - 27.9 inch	EAN/UPC 13 mils: 1.0 - 40.0 cm / 0.4 - 15.7 inch
	PDF417 6.6 mils: 6.5 to 24 cm / 2.6 to 9.4 inch	PDF417 4 mils: 3.0 to 12.0 cm / 1.2 to 4.7 inch
	PDF417 10 mils: 2.5 to 41 cm / 1.0 to 16.1 inch	PDF417 6.6 mils: 0.5 to 23.5 cm / 0.2 to 9.2 inch
	PDF417 15 mils: 2.3 to 65.0 cm / 0.9 to 25.6 inch	PDF417 10 mils: 0.5 to 31.0 cm / 0.2 to 12.2 inch
Resolution (Maximum)	Data Matrix 10 mils: 5.5 to 27 cm / 2.2 to 10.6 inch	Data Matrix 5 mils: 5.5 to 9.0 cm / 2.2 to 3.5 inch
	Data Matrix 15 mils: 2.8 to 41.0 cm / 1.1 to 16.1 inch	Data Matrix 10 mils: 0.2 to 27.0 cm / 0.1 to 10.6 inch
	1D Min = 4 mils PDF417 Min = 5 mils Data Matrix Min = 7.5 mils	1D Min = 3 mils PDF417 Min = 3 mils Data Matrix Min = 4 mils

a. All labels grade A, typical environmental light, 20°C, label inclination 10°

# DECODING CAPABILITIES

DECODE CAPABILITY
<p><b>1D Bar Codes</b></p> <p>UPC/EAN/JAN (A, E, 13, 8); UPC/EAN/JAN (including P2 /P5); UPC/EAN/JAN (including; ISBN / Bookland &amp; ISSN); UPC/EAN Coupons;</p> <p>Code 39 (including full ASCII); Code 39 Trioptic; Code39 CIP HR (French Pharmaceutical); LOGMARS (Code 39 w/ standard check digit enabled); Danish PPT; Code 32 (Italian Pharmacode 39);</p> <p>Code 128; Code 128 ISBT;</p> <p>Interleaved 2 of 5; Standard 2 of 5; Interleaved 2 of 5 CIP (HR); Interleaved 2 of 5 Febraban (for desk models only); Industrial 2 of 5; Discrete 2 of 5; Datalogic 2 of 5 (China Post Code/ Chinese 2 of 5); IATA 2 of 5 Air cargo code; Follet 2 of 5;</p> <p>Codabar; Codabar (NW7); ABC Codabar;</p> <p>Code 11; Code 93; MSI; PZN; Plessey; Anker Plessey;</p> <p>GS1 DataBar Limited; GS1 DataBar Expanded; GS1 DataBar Truncated; DATABAR Expanded Coupon.</p>
<p><b>2D Stacked Codes</b></p> <p>The Gryphon I 4500 family is capable of decoding the following symbologies using multiple frames (i.e. Multi-Frame Decoding):</p> <p>Datamatrix; Inverse Datamatrix; Datamatrix is configurable for the following parameters:; Normal or Inverted; Square or Rectangular Style; Data length (1 - 3600 characters); Maxicode; QR Codes (QR, Micro QR and Multiple QR Codes); Aztec;</p> <p>Postal Codes - (Australian Post; Japanese Post; KIX Post; Planet Code; Postnet; Royal Mail Code (RM45CC); Intelligent Mail Barcode (IMB); Sweden Post; Portugal Post); LaPoste A/R 39; PDF-417; MacroPDF; Micro PDF417; GS1 Composites (1 - 12);</p> <p>French CIP13<sup>a</sup>; GS1 DataBar Stacked; GS1 DataBar Stacked Omnidirectional; GS1 DataBar Expanded Stacked; GS1 Databar Composites; GS1 DotCode;</p> <p>Chinese Sensible Code; Inverted 2D codes<sup>b</sup>.</p>

- a. It is acceptable to handle this with ULE.
- b. The SW can apply the Normal/Reverse Decoding Control to the following symbologies: Datamatrix, QR, Micro QR, Aztec and Chinese Sensible Code.



## LED AND BEEPER INDICATIONS

The reader's beeper sounds and its illumination flashes or changes color to indicate various functions or errors on the reader. A "Green Spot" also lights to indicate a good read. The tables below list these indications.

**Table 29 LED and Beeper Indications**

INDICATION	LED	BEEPER
Power-up	Upper LED flashes/blinks on power-up, however, this may be too rapid to view. With a USB interface, the LED blinks until enumeration with the host is completed.	Reader beeps four times at highest frequency and volume upon power-up.
Good Read	Upper green LED comes on for programmed time (default). LED behavior for this indication is configurable using Aladdin utility.	One beep at current frequency, volume, mono/bi-tonal setting upon a successful label scan. It is also possible to upload custom jingles with Aladdin.
ROM Failure	200 msec on ↔ 200 msec off	Reader sounds one error beep at highest volume for 200 msec.
Limited Scanning Label Read	N/A	Reader 'chirps' six times at the highest frequency and current volume.
Reader Disabled	The LED blinks continuously 100 msec on ↔ 900 msec off	N/A

## USER INDICATIONS FOR GD4500

**Table 30 User Indications for GD4500**

STATUS	3GL AND GOOD READ LED	BUZZER
Power-up	OFF	Rising Beeps' Sequence
USB Enumeration Phase	250 msec <sup>a</sup> ON ↔ 250 msec OFF	OFF
USB Suspend	Depends on Power Cable and specific configurations	OFF
Idle	OFF	OFF
While Reading	OFF	OFF
Decode Done	Solid ON Programmable Duration (1 s default)	Single Beep
Reader Disabled (POS) Communication with host not established	100 msec ON ↔ 900 msec OFF	OFF
Firmware Upgrade	250 msec ON ↔ 250 msec OFF	OFF
Host Download	250 msec ON ↔ 250 msec OFF	OFF
Enter Service Mode	No Effect	Beeps' Sequence
Label Programming	No Effect	Beep

a. "msec" stands for milliseconds, equivalent to 1/1000th of a second

## USER INDICATIONS FOR GBT/GM4500 (GUN ONLY)

Table 31 User Indications for GBT/GM4500 Gun

STATUS	3GL AND GOOD READ LED	BATTERY LED	BUZZER
Power-up	OFF	OFF	Rising Beeps' Sequence
USB Enumeration Phase	250 msec <sup>a</sup> ON ↔ 250 msec OFF	OFF	OFF
USB Suspend	Depends on Power Cable and specific configurations	OFF	OFF
Idle	OFF	OFF	OFF
While Reading	OFF	OFF	OFF
Decode Done	Solid ON Programmable Duration (1 s default)	OFF	Single Beep
Reader Disabled (POS) Communication with host not established	100 msec ON ↔ 900 msec OFF	OFF	OFF
Firmware Upgrade	250 msec ON ↔ 250 msec OFF	OFF	OFF
Host Download	250 msec ON ↔ 250 msec OFF	OFF	OFF
Paging Answer	5 cycles: 100 msec ON ↔ 900 msec OFF	OFF	5 Beeps (when LED ON)
Enter Service Mode	No Effect	OFF	Beeps' Sequence
Label Programming	No Effect	OFF	Beep
ACK Received on Transmission	OFF	OFF	Single Programmable Beep (OFF by default)
ACK NOT Received on Transmission	OFF	OFF	Wrong Beep
base station in USB Suspend	Depends on Power Cable and specific configurations	OFF	OFF
Configuration Alignment	250 msec ON ↔ 250 msec OFF	OFF	OFF
Charge in Progress through microUSB <sup>b</sup>	OFF	Blinking: 1 s ON . 1 s OFF Green (charge = 50% - 99%) Amber (charge = 1% - 49%) Red (charge less than 1%) Reader is unusable until 1% is reached	OFF
Charge Complete through microUSB	OFF	Solid Green It goes OFF when unplugged	OFF
Charge Fault	OFF	OFF	OFF
Charge in Progress through base station	OFF	OFF	OFF

STATUS	3GL AND GOOD READ LED	BATTERY LED	BUZZER
Charge Complete through base station	OFF	OFF	OFF
Battery Status indications when not charging, using double tap	OFF	Solid with programmable duration (3 s default) and then OFF Green (charge = 50% - 100%) Amber (charge = 2% - 50%) Red forced loop (charge less than 2%)	OFF

- a. "msec" stands for milliseconds, equivalent to 1/1000th of a second
- b. In case of heavily depleted battery (e.g. if the reader has not been used for a long time), the reader being charged will not be operational for a certain amount of time, which can vary from just a few minutes to 30-40 minutes depending on battery discharge level and power supplied to the base station (i.e. longer time if the base station is connected to USB only without external power supply).

## USER INDICATIONS FOR WLC4090 BASE STATIONS

Table 32 User Indications for WLC4090 Base Stations

STATUS	TRANSMISSION LEDES	CHARGING LEDES
Power-up	Solid ON	OFF
USB Enumeration	250 msec <sup>a</sup> ON ↔ 250 msec OFF	OFF
USB Suspend	Depends on Power Cable and specific configurations	OFF
Idle	Solid ON	OFF
While Reading	Solid ON	OFF
Label Transmitted to Host	OFF for 100 msec andd then Solid ON	OFF
Reader Disabled (POS) Communication with host not established	100 msec ON ↔ 900 msec OFF	OFF
Firmware Upgrade	250 msec ON ↔ 250 msec OFF	OFF
Host Download	250 msec ON ↔ 250 msec OFF	OFF
Configuration Alignment	250 msec ON ↔ 250 msec OFF	OFF
Enter Service Mode	No Effect (remains Solid ON)	OFF
Short button press (1-5 s) Paging request	Blink Green 500 msec ON ↔ 500 msec OFF (for 5 s while pressing button)	OFF
Long button press (6-10 s) Flush Piconet request	Blink Green 1 s ON ↔ 1 s OFF (for 5 s while pressing button)	OFF
Charge in Progress	No Effect	Fading: 1 s ON ↔ 1 s OFF Green (charge = 50% - 99%) Amber (charge = 0% - 49%)
Charge Complete	No Effect	Solid Green It goes OFF when unplugged
Charge Fault	No Effect	OFF
Electrical Fault	OFF	OFF

a. "msec" stands for milliseconds, equivalent to 1/1000th of a second

## PROGRAMMING MODE

The following indications ONLY occur when the reader is in Programming Mode.

INDICATION	DESCRIPTION	LED	BEEPER
<b>Enter Programming Mode</b>	A valid programming label has been scanned.	LED blinks continuously	Reader sounds four low frequency beeps.
<b>Rejection of Label</b>	Label has been rejected.	N/A	Reader sounds three times at lowest frequency & current volume.
<b>Acceptance of Partial Label</b>	In cases where multiple labels must be scanned to program one feature, this indication acknowledges each portion as it is successfully scanned.	N/A	Reader sounds one short beep at highest frequency & current volume.
<b>Acceptance of Programming</b>	Configuration option(s) have been successfully programmed via labels and the reader has exited Programming Mode.	N/A	Reader sounds one high frequency beep and four low frequency beeps followed by reset beeps.
<b>Cancel Item Entry</b>	Cancel label has been scanned.	N/A	Reader sounds twice at low frequency & current volume.

## TROUBLESHOOTING

PROBLEM	POSSIBLE CAUSE	POSSIBLE SOLUTION
<b>Nothing happens when the scan button is pulled.</b>	No power to the reader	Check system power. Ensure power supply is connected.
	Interface or power cables are loose.	Ensure all cable connections are secure.
<b>LED comes on but bar code does not decode.</b>	Reader not programmed for correct bar code type.	Ensure reader is programmed to read the type of bar code scanned.
	Bar code label is unreadable.	Check the label to ensure it is not defaced. Try scanning another bar code type.
	Distance between reader and bar code is incorrect.	Move reader closer to or further from the bar code.
<b>Bar code is decoded but not transmitted to the host.</b>	Reader not programmed for the correct host type.	Scan the appropriate host type bar code.

Figure 25 and Table 33 provide standard pinout information for the reader’s cable.

**Figure 25 Standard Cable Pinouts**

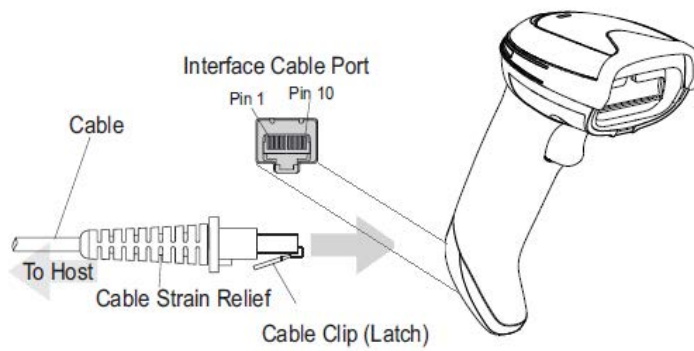

The signal descriptions in Table 33 apply to the connector on the reader and are for reference only.

**Table 33 Standard Cable Pinouts — Reader Side**

PIN	RS232	USB	KEYBOARD WEDGE
1	RTS (out)		
2		D+	CLKIN (KBD side)
3		D-	DATAIN (KBD side)
4	GND	GND	GND
5	RX		
6	TX		
7	VCC	VCC	VCC
8			CLKOUT (PC side)
9			DATAOUT (PC side)
10	CTS (in)		

# APPENDIX B

## STANDARD DEFAULTS

The most common configuration settings are listed in the “Default” column of the table below. Page references are also provided for feature descriptions and programming bar codes for each parameter. A column has also been provided for recording of your preferred default settings for these same configurable features.

**Table 34 Standard Defaults**

PARAMETERS	DEFAULT	YOUR SETTING	PAGE NUMBER
<b>GLOBAL INTERFACE FEATURES</b>			
Host Commands — Obey/Ignore	Obey		35
USB Suspend Mode	Enable		35
<b>RS-232 ONLY</b>			
Baud Rate	9600		37
Data Bits	8 Data Bits		38
Stop Bits	1 Stop Bit		38
Parity	None		39
Handshaking Control	RTS		40
<b>RS-232/USB-COM</b>			
Intercharacter Delay	No Delay		42
Beep On ASCII BEL	Disable		43
Beep On Not on File	Enable		43
ACK NAK Options	Disable		44
ACK Character	‘ACK’		45
NAK Character	‘NAK’		45
ACK NAK Timeout Value	200 msec		46
ACK NAK Retry Count	3 Retries		45
ACK NAK Error Handling	Ignore Errors Detected		47

PARAMETERS	DEFAULT	YOUR SETTING	PAGE NUMBER
Indicate Transmission Failure	Enable		47
Disable Character	'D'		48
Enable Character	'E'		48
<b>KEYBOARD WEDGE</b>			
Setting Country Mode	U.S. Keyboard		51
Encoding Type	Don't Use Encoding		65
ALT Output Type	ALT Unicode		72
Caps Lock State	Caps Lock OFF		73
Numlock	Numlock Key Unchanged		73
Keyboard Numeric Keypad	Standard Keys		74
Keyboard Send Control Characters	Send Ctrl+Key		74
Wedge Quiet Interval	10 = Quiet Interval of 100 msec		75
Intercharacter Delay	00 = No Intercharacter Delay		76
Intercode Delay	00 = No Wedge Intercode Delay		76
USB Keyboard Speed	1ms		77
<b>USB OEM</b>			
USB-OEM Device Usage	Handheld		79
USB-OEM Interface Options	Obey Reader Configuration Host Commands		79
<b>IBM 46XX INTERFACE</b>			
IBM 46xx Interface Options	Obey Reader Configuration Host Commands		81
<b>DATA FORMAT</b>			
Global Prefix/Suffix	No Global Prefix Global Suffix = 0x0D (CR)		83
Case Conversion	Disable (no case conversion)		84
Character Conversion	0xFFFFFFFFFFFFFFFF (no character conversion)		84
Global AIM ID	Disable		85
GS1-128 AIM ID	Disable		85
Label ID: Pre-loaded Sets	USA Set		86
Label ID Control	Disable		87
Label ID Symbology Selection			88



PARAMETERS	DEFAULT	YOUR SETTING	PAGE NUMBER
<b>READING PARAMETERS</b>			
Scan Mode	Trigger Simple		94
Scanning Active Time	5 seconds		95
Flash On Time	10 = Flash is ON for 1 second		95
Flash Off Time	06 = Flash is OFF for 600ms		96
Double Read Timeout	0.6 second		96
Stand /Base Detection Behavior	Switch to Stand Mode/Object Detection		98
Stand Mode/Object Detection Indication (Stand Mode Flash)	Disable		99
Stand Mode/Object Detection Sensitivity	Medium		99
Stand Mode/Object Detection Illumination Off Time	1 second		100
Illumination Intensity	Full Intensity		100
Illuminator Refresh Frequency	Normal Refresh Frequency		101
Corded Stand Mode	Disable		101
Dock Detection Beep	Disable		102
Corded Stand Beep	Disable		102
Power On Alert	Power-up Beep		103
Good Read Beep Type	Mono		103
Good Read Beep Frequency	High		104
Good Read Beep Length	80 msec		105
Good Read Beeper Volume / Vibration	High		106
Vibration Feedback for Good Read	Disable		106
Silent Mode	Disable		107
RGB Good Read Enable	Enable		107
RGB Good Read Color	GREEN		108
Good Read LED Duration	300 msec		109
Good Read: When to Indicate	After Decode		110
Green Spot Duration	Short (300 msec)		111
Aiming Pointer	Enable		112
Aiming Duration Timer	Aiming Off After Decoding		112

PARAMETERS	DEFAULT	YOUR SETTING	PAGE NUMBER
Pick Mode	Disable		113
Mobile Phone Mode	Enable		113
Mobile Phone Saturation Rate	00		114
Decode Negative Image	Disable		115
Multiple Labels per Frame	Disable		116
Multiple Labels Ordering by Code Symbology	Random Order		116
Multiple Labels Ordering by Code Length	Disable		117
<b>CODE SELECTION - 1D SYMBOLOGIE</b>			
<b>Code EAN/UPC</b>			
Coupon Control	Enable only UPC/EAN		119
<b>UPC-A</b>			
UPC-A Enable/Disable	Enable		120
UPC-A Check Character Transmission	Send		120
Expand UPC-A to EAN-13	Don't expand		121
UPC-A Number System Character Transmission	Transmit		121
<b>UPC-E</b>			
UPC-E Enable/Disable	Enable		122
UPC-E Check Character Transmission	Send		122
Expand UPC-E to EAN-13	Don't expand		123
Expand UPC-E to UPC-A	Don't expand		123
UPC-E Number System Character Transmission	Transmit		123
<b>GTIN</b>			
GTIN Formatting	Disable		124
<b>EAN 13 (Jan 13)</b>			
EAN-13 Enable/Disable	Enable		125
EAN-13 Check Character Transmission	Send		125
EAN-13 Flag 1 Character	Transmit		126

PARAMETERS	DEFAULT	YOUR SETTING	PAGE NUMBER
EAN-13 to ISBN Conversion	Disable		126
<b>ISSN</b>			
EAN-13 to ISSN Conversion	Disable		127
<b>EAN 8</b>			
EAN-8 Enable/Disable	Enable		128
EAN-8 Check Character Transmission	Send		128
Expand EAN-8 to EAN-13	Don't Expand		129
<b>UPC/EAN Global Settings</b>			
UPC/EAN Price Weight Check	Disable		130
UPC/EAN Quiet Zones	Two Modules		131
<b>ADD-ONS</b>			
Optional Add-ons	Disable P2 and P5		132
Optional Add-On Timer	70 msec		133
<b>GS1 DATABAR™ OMNIDIRECTIONAL</b>			
GS1 DataBar Omnidirectional Enable/Disable	Disable		134
GS1 DataBar Omnidirectional to GS1-128 Emulation	Disable		134
GS1 DataBar Expanded Enable/Disable	Disable		135
GS1 DataBar Expanded to GS1-128 Emulation	Disable		135
GS1 DataBar Expanded Length Control	Variable		136
GS1 DataBar Expanded Set Length 1	1		136
GS1 DataBar Expanded Set Length 2	74		137
<b>GS1 DATABAR™ LIMITED</b>			
GS1 DataBar Limited Enable/Disable	Disable		138
GS1 DataBar Limited to GS1-128 Emulation	Disable		138
<b>CODE 39</b>			
Code 39 Enable/Disable	Enable		139
Code 39 Check Character Calculation	Don't calculate		139

PARAMETERS	DEFAULT	YOUR SETTING	PAGE NUMBER
Code 39 Check Character Transmission	Send		140
Code 39 Start/Stop Character Transmission	Don't transmit		140
Code 39 Full ASCII	Disable		141
Code 39 Quiet Zones	Small Quiet Zones on two sides		141
Code 39 Length Control	Variable		142
Code 39 Set Length 1	2		142
Code 39 Set Length 2	50		143
<b>TRIOPTIC CODE</b>			
Trioptic Code Enable/Disable	Disable		144
<b>CODE 39 DANISH PPT</b>			
Code 39 Danish PPT Enable/Disable	Disable		144
<b>CODE 39 PZN</b>			
Code 39 PZN Enable/Disable	Disable		145
<b>CODE 39 LA POSTE</b>			
Code 39 La Poste Enable/Disable	Disable		145
<b>CODE 32 (Italian Pharmaceutical Code)</b>			
Code 32 Enable/Disable	Disable		146
Code 32 Check Character Transmission	Don't Send		146
Code 32 Start/Stop Character Transmission	Don't Transmit		147
<b>Code 39 CIP HR (French Pharmaceutical Code)</b>			
Code 39 CIP HR Enable/Disable	Disable		148
<b>SPECIAL CODES</b>			
<b>Code 128</b>			
Code 128 Enable/Disable	Enable		149
Expand Code 128 to Code 39	Don't Expand		149
Code 128 Check Character Transmission	Don't Send		150
Code 128 Function Character Transmission	Don't Send		150
Code 128 Quiet Zones	Auto		151

PARAMETERS	DEFAULT	YOUR SETTING	PAGE NUMBER
Code 128 Length Control	Variable		151
Code 128 Set Length 1	1		152
Code 128 Set Length 2	80		152
<b>GS1-128</b>			
GS1-128 Enable	Transmit in Code 128 Data Format		153
<b>INTERLEAVED 2 of 5</b>			
I 2 of 5 Enable/Disable	Disable		154
I 2 of 5 Check Character Calculation	Disable		155
I 2 of 5 Check Character Transmission	Send		156
I 2 of 5 Length Control	Variable		157
I 2 of 5 Set Length 1	6		157
I 2 of 5 Set Length 2	50		158
<b>INTERLEAVED 2 of 5, FEBRABAN FORMAT (Desk Models Only)</b>			
Interleaved 2 of 5, Febraban format Enable / Disable	Disable		159
<b>INTERLEAVED 2 of 5 CIP HR</b>			
Interleaved 2 of 5 CIP HR Enable/Disable	Disable		160
<b>MATRIX 2 of 5</b>			
Matrix 2 of 5 Enable/Disable	Disable		161
Matrix 2 of 5 Check Character Calculation	Disable		161
Matrix 2 of 5 Check Character Transmission	Send		162
Matrix 2 of 5 Length Control	Variable Length		162
Matrix 2 of 5 Set Length 1	8 characters		163
Matrix 2 of 5 Set Length 2	50 characters		163
<b>STANDARD 2 of 5</b>			
Standard 2 of 5 Enable/Disable	Disable		164
Standard 2 of 5 Check Character Calculation	Disable		164
Standard 2 of 5 Check Character Transmission	Send		165

PARAMETERS	DEFAULT	YOUR SETTING	PAGE NUMBER
Standard 2 of 5 Length Control	Variable Length		165
Standard 2 of 5 Set Length 1	08 (8 characters)		166
Standard 2 of 5 Set Length 2	50 (50 characters)		166
<b>COMPRESSED 2 of 5</b>			
Compressed 2 of 5 Enable/Disable	Disable		167
Compressed 2 of 5 Check Character Calculation	Disable		167
Compressed 2 of 5 Check Character Transmission	Send		168
Compressed 2 of 5 Length Control	Variable Length		168
Compressed 2 of 5 Set Length 1	1 character		169
Compressed 2 of 5 Set Length 2	50 characters		169
<b>DATALOGIC 2 OF 5</b>			
Datalogic 2 of 5 Enable/Disable	Disable		170
Datalogic 2 of 5 Check Character Calculation	Disable		170
Datalogic 2 of 5 Check Character Transmission	Send		171
Datalogic 2 of 5 Length Control	Variable Length		171
Datalogic 2 of 5 Set Length 1	6 characters		172
Datalogic 2 of 5 Set Length 2	50 characters		172
<b>INDUSTRIAL 2 of 5</b>			
Industrial 2 of 5 Enable/Disable	Disable		173
Industrial 2 of 5 Check Character Calculation	Disable		173
Industrial 2 of 5 Check Character Transmission	Send		174
Industrial 2 of 5 Length Control	Variable		174
Industrial 2 of 5 Set Length 1	6 characters		175
Industrial 2 of 5 Set Length 2	50 characters		175
<b>CODE IATA</b>			
IATA Enable/Disable	Disable		176
IATA Check Character Transmission	Send		176
<b>FOLLET 2 OF 5</b>			

PARAMETERS	DEFAULT	YOUR SETTING	PAGE NUMBER
Follett 2 of 5 Enable/Disable	Disable		177
<b>CODABAR</b>			
Codabar Enable/Disable	Disable		178
Codabar Check Character Calculation	Disable		178
Codabar Check Character Transmission	Send		179
Codabar Start/Stop Character Transmission	Transmit		179
Codabar Start/Stop Character Set	abcd/abcd		180
Codabar Start/Stop Character Match	Don't Require Match		180
Codabar Quiet Zones	Quiet Zones on two sides		181
Codabar Length Control	Variable		182
Codabar Set Length 1	3 characters		182
Codabar Set Length 2	50 characters		183
<b>ABC CODABAR</b>			
ABC Codabar Enable/Disable	Disable		184
ABC Codabar Concatenation Mode	Static		184
ABC Codabar Dynamic Concatenation Timeout	200 msec		185
ABC Codabar Force Concatenation	Disable		185
<b>ISBT-128</b>			
ISBT 128 Concatenation	Disable		186
ISBT 128 Concatenation Mode	Static		186
ISBT 128 Dynamic Concatenation Timeout	200 msec		187
ISBT 128 Force Concatenation	Disable		188
ISBT 128 Advanced Concatenation Options	Disable		188
<b>CODE 11</b>			
Code 11 Enable/Disable	Disable		189
Code 11 Check Character Calculation	Check C and K		189
Code 11 Check Character Transmission	Send		190

PARAMETERS	DEFAULT	YOUR SETTING	PAGE NUMBER
Code 11 Length Control	Variable		190
Code 11 Set Length 1	4 characters		191
Code 11 Set Length 2	50 characters		191
<b>CODE 93</b>			
Code 93 Enable/Disable	Disable		192
Code 93 Check Character Calculation	Enable Check C and K		192
Code 93 Check Character Transmission	Disable		193
Code 93 Length Control	Variable		193
Code 93 Set Length 1	1 character		194
Code 93 Set Length 2	50 characters		194
Code 93 Quiet Zones	Auto		195
<b>MSI</b>			
MSI Enable/Disable	Disable		196
MSI Check Character Calculation	Calculate Mod 10		196
MSI Check Character Transmission	Send		197
MSI Length Control	Variable		197
MSI Set Length 1	1 character		198
MSI Set Length 2	50 characters		198
<b>PHARMACODE</b>			
Pharmacode Enable/Disable	Disable		199
Pharmacode Label Direction	Horizontal left to right		199
Pharmacode Length Control	Variable		200
Pharmacode Set Length 1	02 characters		200
Pharmacode Set Length 2	6 characters		201
<b>PLESSEY</b>			
Plessey Enable/Disable	Disable		202
Plessey Check Character Calculation	Plessey std check char. verification		202
Plessey Check Character Transmission	Send		203
Plessey Length Control	Variable		203
Plessey Set Length 1	1 character		204



PARAMETERS	DEFAULT	YOUR SETTING	PAGE NUMBER
Plessey Set Length 2	50 characters		204
<b>BC412</b>			
BC412 Enable/Disable	Disable		205
BC412 Check Character Calculation	Calculate		205
BC412 Length Control	Variable		206
BC412 Set Length 1	1 character		207
BC412 Set Length 2	50 characters		207
<b>CODE SELECTION - 2D SYMBOLOGIES</b>			
2D Maximum Decoding Time	350 msec		210
2D Structured Append	Disable		211
2D Normal/Inverse Symbol Control	Normal		211
<b>AZTEC CODE</b>			
Aztec Code Enable / Disable	Enable		212
Aztec Code Length Control	Variable		212
Aztec Code Set Length 1	1 character		211
Aztec Code Set Length 2	3,832 characters		213
<b>CHINA SENSIBLE CODE</b>			
China Sensible Code Enable / Disable	Disable		214
China Sensible Code Length Control	Variable		214
China Sensible Code Set Length 1	1 character		215
China Sensible Code Set Length 2	7,827 characters		215
<b>DATA MATRIX</b>			
Data Matrix Enable / Disable	Enable		216
Data Matrix Square/Rectangular Style	Both Square and Rectangular Style		216
Data Matrix Length Control	Variable		217
Data Matrix Set Length 1	1 character		217
Data Matrix Set Length 2	3,116 characters		218
<b>GS1 DOTCODE</b>			
DotCode Enable	Disable		219
DotCode High Resolution Enable	Enable		219

PARAMETERS	DEFAULT	YOUR SETTING	PAGE NUMBER
DotCode Position-based Decoding	Disable		220
<b>MAXICODE</b>			
Maxicode Enable / Disable	Disable		221
Maxicode Primary Message Transmission	Disable		221
Maxicode Length Control	Variable		222
Maxicode Set Length 1	1 character		222
Maxicode Set Length 2	0145 characters		223
<b>PDF417</b>			
PDF417 Enable / Disable	Enable		224
PDF417 Length Control	Variable		224
PDF417 Set Length 1	1 character		225
PDF417 Set Length 2	2,710 characters		225
<b>MICRO PDF417</b>			
Micro PDF417 Enable / Disable	Enable		226
Micro PDF417 Code 128 GS1-128 Emulation	Micro PDF AIM ID and label type		226
Micro PDF417 Length Control	Variable		227
Micro PDF417 Set Length 1	1 character		227
Micro PDF417 Set Length 2	0366 characters		228
<b>QR CODE</b>			
QR Code Enable / Disable	Enable		229
QR Code Length Control	Variable		229
QR Code Set Length 1	1 character		230
QR Code Set Length 2	7,089 characters		230
<b>MICRO QR CODE</b>			
Micro QR Code Enable / Disable	Enable		231
Micro QR Code Length Control	Variable		231
Micro QR Code Set Length 1	1 character		232
Micro QR Code Set Length 2	0035 characters		232
<b>UCC COMPOSITE</b>			
UCC Optional Composite Timer	Timer Disabled		233

PARAMETERS	DEFAULT	YOUR SETTING	PAGE NUMBER
Postal Code Selection	Disable All Postal Codes		234
Postnet BB Control	Disable		235
<b>OCR DECODING</b>			
OCR Decoding Predefined Templates	Disable		237
<b>MOTION FEATURES</b>			
Motionless Timeout	2 seconds		239
Motion Sensitivity	Medium		239
High Motion Immunity	Disable		240
Motion Aiming Control	Enable		240
<b>POWER MANAGEMENT</b>			
Powerdown Timeout	30 minutes		242
Battery Profiles	Maximum Performance		243
<b>WIRELESS FEATURES</b>			
Good Transmission Beep	Enable		246
Beeper Frequency	Low		246
Beep Duration	80 msec		247
Beep Volume	High		248
Disconnect Beep	Enable		248
Docking (Connecting) Beep	Enable		249
Leash Alarm	Disable		249
Automatic Configuration Update	Enable		251
Batch Mode	Disable		252
RF Batch Mode Transmit Delay	No Delay		253
Direct Radio Autolink	Unlink Label Required		254
Source Radio Address Transmission	Do Not Include		255
Source Radio Address Delimiter Character	00 (no delimiter character)		255
Bluetooth Security Level	Level 1 - Lowest		256
Bluetooth Radio Output Power	Class 1 - Highest		257
Wi-Fi Channels Exclusion	Automatic		258
Bluetooth HID Alt Mode	OFF		263

## STANDARD DEFAULTS

---

PARAMETERS	DEFAULT	YOUR SETTING	PAGE NUMBER
STAR Radio Protocol Timeout	02 (2 seconds)		264
STAR Radio Transmit Mode	ACK from Base Station		265
STAR System Speed	High Speed		266
STAR Frequency Agility	Disable		267

## DEFAULT EXCEPTIONS

Table 35 - Default Exceptions by Interface Type

PARAMETER	DEFAULT EXCEPTION
<b>Interfaces: USB-OEM</b>	
Global Suffix	No Global Suffix
Double Read Timeout	500 msec
<b>Interfaces: All Keyboard Wedge, USB Keyboard</b>	
No unique settings	
<b>Interface: RS232-WN</b>	
Expand UPC-A to EAN-13	Enable
UPC-E Check Character Transmission	Disable
Parity	Odd Parity
Handshaking Control	RTS/CTS
Transmission Label ID Code	Prefix
GS1-128 AIM ID	Disable
UPCE Label ID Character(s)	C
EAN 8 Label ID Character(s)	B
EAN 13 Label ID Character(s)	A
Code ISBN Label ID Character(s)	A
Code 39 Label ID Character(s)	M
MInterleaved 2of5 Label ID Character(s)	I
Code Standard 2/5 Label ID Character(s)	H
Codabar Label ID Character(s)	N
Code 128 Label ID Character(s)	K
GS1-128 Label ID Character(s)	P
Datalogic 2 of 5 Label ID Character(s)	H
ISBT 128 Label ID Character(s)	K
UPCE P2 Label ID Character(s)	C
UPCE/P5 Label ID Character(s)	C
UPCE/GS1-128 Label ID Character(s)	C
EAN8/P2 Label ID Character(s)	B
EAN8/P5 Label ID Character(s)	B
EAN8/GS1-128 Label ID Character(s)	B
EAN13/P2 Label ID Character(s)	A
EAN13/P5 Label ID Character(s)	A
EAN13/GS1-128 Label ID Character(s)	A

PARAMETER	DEFAULT EXCEPTION
GS1 DataBar 14 (Omnidirectional) Label ID Character(s)	E
GS1 DataBar Expanded Label ID Character(s)	E
GS1 DataBar Limited Label ID Character(s)	E
Character Conversion	CR to `
<b>Interface: RS232-OPOS</b>	
Baud Rate	115200 Baud
Transmission Label ID Code	Prefix
GS1-128 AIM ID	Disable
UPCA Label ID Character(s)	C
UPCE Label ID Character(s)	D
EAN 8 Label ID Character(s)	A
EAN 13 Label ID Character(s)	B
Code ISBN Label ID Character(s)	@
Code 39 Label ID Character(s)	V
Code 32 Label ID Character(s)	X
Interleaved 2of5 Label ID Character(s)	N
Code Standard 2/5 Label ID Character(s)	P
Codabar Label ID Character(s)	R
Code 11 Label ID Character(s)	b
Code 128 Label ID Character(s)	T
GS1-128 Label ID Character(s)	k
UPCA/P2 Label ID Character(s)	F
UPCA/P5 Label ID Character(s)	G
UPCA/GS1-128 Label ID Character(s)	Q
UPCE P2 Label ID Character(s)	H
UPCE/P5 Label ID Character(s)	I
EAN8/P2 Label ID Character(s)	J
EAN8/P5 Label ID Character(s)	K
EAN8/GS1-128 Label ID Character(s)	*
EAN13/P2 Label ID Character(s)	L
EAN13/P5 Label ID Character(s)	M
EAN13/GS1-128 Label ID Character(s)	#
GS1 DataBar 14 (Omnidirectional) Label ID Character(s)	u
GS1 DataBar Expanded Label ID Character(s)	t
GS1 DataBar Limited Label ID Character(s)	v

# APPENDIX C

## SAMPLE BARCODES

---

The sample bar codes in this appendix are typical representations for their symbology types.

### SAMPLE BARCODES

#### 1D Barcodes

**UPC-A**



**EAN-13**



**Code 39**



**Code 128**



**Interleaved 2 of 5**



**Code 32**



**Codabar**



**Code 93**



**Code 11**





## GS1 Databar™ (RSS)

GS1 DataBar™ variants must be enabled to read the barcodes below (see "GS1 DataBar™ Omnidirectional" on page 134).

### GS1 DataBar™ Expanded Stacked



10293847560192837465019283746029478450366523

### GS1 DataBar™ Expanded



1234890hjjio9900mnb

### GS1 DataBar™ Limited



08672345650916

## GS1 Databar™ (-14)

### GS1 DataBar™ Omnidirectional Truncated



55432198673467

### GS1 DataBar™ Omnidirectional Stacked



90876523412674

### GS1 DataBar™ Omnidirectional Stacked



78123465709811

## 2D Barcodes

**Aztec**



**Data Matrix**



**China Sensible**



**MaxiCode**

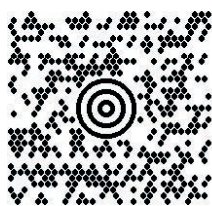

*Test Message*

**PDF417**



ABCabc

**Micro PDF 417**



BV17453

**QR Code**

35900G9

**2D Barcodes (continued)****Micro QR Code**

123456

**UCC Composite**

(17) 050923 (10) ABC123



(01) 0 4012345 67890 1 1

# APPENDIX D

## KEYPAD

---

Use the bar codes in this appendix to enter numbers as you would select digits/characters from a keypad.



1



2



3



4



5



6



7



1



2



3



4



5



6



7



8



9

# APPENDIX E

## SCANCODE TABLES

---

### CONTROL CHARACTER EMULATION

Control character emulation selects from different scancode tables as listed in this appendix. Each of the control character sets below are detailed by interface type in the tables. These apply to Wedge and USB Keyboard platforms.

**Control Character 00** : Characters from 00 to 0x1F are sent as control character Ctrl+Keys, special keys are located from 0x80 to 0xA1.

**Control Character 01** : Characters from 00 to 0x1F are sent as control character Ctrl+Capital Key, special keys are located from 0x80 to 0xA1.

**Control Character 02** : Special keys are located from 00 to 0x1F and characters from 0x80 to 0xFE are intended as an extended ASCII table (Microsoft Windows Codepage 1252 — see [page 344](#)).

### Single Press and Release Keys

In the following tables, Ar↓ means Alt right pressed and Ar↑ means Alt right released and so on. Definitions for other keys are Al (Alt left ), Cr (Control Right ) Cl (Control Left ) Sh (shift). This method can be used for combining Alt, Control or Shift with other keys.

Example: Consider a Control character set to 00. If AltRight+A is required before sending a label to the host, it could be done by setting three Prefix keys in this way: 0x99 0x41 0x9A.

# INTERFACE TYPE PC AT PS/2, USB-KEYBOARD OR USB-KEYBOARD FOR APPLE

Table 36. Scancode Set When Control Character is 00 or 01

	x0	x1	x2	x3	x4	x5	x6	x7	x8	x9	xA	xB	xC	xD	xE	xF
0x	NULL C+@	SOH C(S)+A	STX C(S)+B	ETX C(S)+C	EOT C(S)+D	ENQ C(S)+E	ACK C(S)+F	BEL C(S)+G	BS CAN C(S)+X	HT TAB EM C(S)+Y	LF C(S)+J SUB C(S)+Z	VT C(S)+K ESC Esc	FF C(S)+L FS C+^	CR Enter GS C+]	SO C(S)+N RS C+^	SI C(S)+O US C(S)+_
1x	DLE C(S)+P	DC1 C(S)+Q	DC2 C(S)+R	DC3 C(S)+S	DC4 C(S)+T	NAK C(S)+U	SYN C(S)+V	ETB C(S)+W			*	+	,	-	.	/
2x	SP	!	"	#	\$	%	&	'	(	)	*	+	,	-	.	/
3x	0	1	2	3	4	5	6	7	8	9	:	;	<	=	>	?
4x	@	A	B	C	D	E	F	G	H	I	J	K	L	M	N	O
5x	P	Q	R	S	T	U	V	W	X	Y	Z	[	\	]	^	_
6x	,	a	b	c	d	e	f	g	h	i	j	k	l	m	n	o
7x	p	q	r	s	t	u	v	w	x	y	z	{		}	~	Del
8x	€	Sh↓	Sh↑	Ins	Ent (keyp) Pg Dwn	F1	F2	F3	F4	F5	F6	F7	F8	F9	F10	F11
9x	F12	Home	End	Pg Up	↑	↓	←	→	Ar↓	Ar↑	Ar↑	Al↓	Al↑	Cl↓	Cl↑	Cr↓
Ax	Cr↑		'	<i>f</i>	”	†	‡	‡	^	% <sub>00</sub>	Š	<	Š	<	Œ	
Bx	°	±	²	³	´	µ	¶	·	,	ı	°	»	¼	½	¾	ı
Cx	À	Á	Â	Ã	Ä	Å	Æ	Ç	È	É	Ê	Ë	Ì	Í	Î	Ï
Dx	Ð	Ò	Ó	Ô	Õ	Ö	Ø	×	Ù	Ú	Û	Ü	Ý	Þ	ß	
Ex	à	á	â	ã	ä	å	æ	ç	è	é	ê	ë	ì	í	î	ï
Fx	ø	ñ	ò	ó	ô	ö	ø	÷	ù	ú	û	ü	ý	ÿ		

Extended characters (sky blue) are sent through dedicated keys (when available in the selected country mode) or by using an Alt Mode sequence.

# INTERFACE TYPE PC AT PS/2, USB-KEYBOARD OR USB-KEYBOARD FOR APPLE (CONTINUED)

Table 37. Scancode Set When Control Character is 02

	x0	x1	x2	x3	x4	x5	x6	x7	x8	x9	xA	xB	xC	xD	xE	xF
0x	Alt↓	Alt↑	Alt↓	Alt↑	Ctrl↓	Ctrl↑	Ctrl↓	Ctrl↑	BS	Tab	→	S+Tab	Enter Keyprd	Enter	Ins	Pg Up
1x	Pg Dwn	Home	←	→	↑	F6	F1	F2	F3	F4	F5	ESC	F7	F8	F9	F10
2x	Space	!	“	#	\$	%	&	‘	(	)	*	+	,	-	.	/
3x	0	1	2	3	4	5	6	7	8	9	:	;	<	=	>	?
4x	@	A	B	C	D	E	F	G	H	I	J	K	L	M	N	O
5x	P	Q	R	S	T	U	V	W	X	Y	Z	[	\	]	^	_
6x	`	a	b	c	d	e	f	g	h	i	j	k	l	m	n	o
7x	p	q	r	s	t	u	v	w	x	y	z	{		}	~	Del
8x	€	‘	’	f	”	…	†	‡	^	%00	Š	<	Š	<	Œ	
9x		‘	’	“	”	•	—	—	~	™	š	>	œ		ž	ÿ
Ax	NBSP	ı	ı	£	ı	ı	ı	ı	ı	ı	ı	ı	ı	ı	ı	ı
Bx	°	±	²	³	´	µ	¶	·	,	ı	°	»	¼	½	¾	ı
Cx	À	Á	Â	Ã	Ä	Å	Æ	Ç	È	É	Ê	Ë	Ì	Í	Î	Ï
Dx	Ð		Ò	Ó	Ô	Õ	Ö	×	Ø	Ù	Ú	Û	Ü	Ý	Þ	ß
Ex	à	á	â	ã	ä	å	æ	ç	è	é	ê	ë	ì	í	î	ï
Fx	ð	ñ	ò	ó	ô	õ	ö	÷	ø	ù	ú	û	ü	ý	þ	ÿ



# INTERFACE TYPE PC AT PS/2 ALT MODE OR USB-KEYBOARD ALT MODE

Table 38. Scancode Set When Control Character is 00 or 01

	x0	x1	x2	x3	x4	x5	x6	x7	x8	x9	xA	xB	xC	xD	xE	Fx
0x	Alt+000	Alt+001	Alt+002	Alt+003	Alt+004	Alt+005	Alt+006	Alt+007	BS	HT TAB	Alt+010	Alt+011	Alt+012	CR Enter	Alt+014	Alt+015
1x	Alt+016	Alt+017	Alt+018	Alt+019	Alt+020	Alt+021	Alt+022	Alt+023	Alt+024	Alt+025	Alt+026	ESC Esc	Alt+028	Alt+029	Alt+030	Alt+031
2x	A+032	A+033	A+034	A+035	A+036	A+037	A+038	A+039	A+040	A+041	A+042	A+043	A+044	A+045	A+046	A+047
3x	A+048	A+049	A+050	A+051	A+052	A+053	A+054	A+055	A+056	A+057	A+058	A+059	A+060	A+061	A+062	A+063
4x	A+064	A+065	A+066	A+067	A+068	A+069	A+070	A+071	A+072	A+073	A+074	A+075	A+076	A+077	A+078	A+079
5x	A+080	A+081	A+082	A+083	A+084	A+085	A+086	A+087	A+088	A+089	A+090	A+091	A+092	A+093	A+094	A+095
6x	A+096	A+097	A+098	A+099	A+100	A+101	A+102	A+103	A+104	A+105	A+106	A+107	A+108	A+109	A+110	A+111
7x	A+112	A+113	A+114	A+115	A+116	A+117	A+118	A+119	A+120	A+121	A+122	A+123	A+124	A+125	A+126	A+127
8x	€	Sh↓	Sh↑	Ins	Ent (keyp)	F1	F2	F3	F4	F5	F6	F7	F8	F9	F10	F11
9x	F12	Home	End	Pg Up	Pg Dwn	↑	↓	←	→	Ar↓	Ar↑	Al↓	Al↑	Cl↓	Cl↑	Cr↓
Ax	Cr↑	A+0161	A+0162	A+0163	A+0164	A+0165	A+0166	A+0167	A+0168	A+0169	A+0170	A+0171	A+0172	A+0173	A+0174	A+0175
Bx	A+0176	A+0177	A+0178	A+0179	A+0180	A+0181	A+0182	A+0183	A+0184	A+0185	A+0186	A+0187	A+0188	A+0189	A+0190	A+0191
Cx	A+0192	A+0193	A+0194	A+0195	A+0196	A+0197	A+0198	A+0199	A+0200	A+0201	A+0202	A+0203	A+0204	A+0205	A+0206	A+0207
Dx	A+0208	A+0209	A+0210	A+0211	A+0212	A+0213	A+0214	A+0215	A+0216	A+0217	A+0218	A+0219	A+0220	A+0221	A+0222	A+0223
Ex	A+0224	A+0225	A+0226	A+0227	A+0228	A+0229	A+0230	A+0231	A+0232	A+0233	A+0234	A+0235	A+0236	A+0237	A+0238	A+0239
Fx	A+0240	A+0241	A+0242	A+0243	A+0244	A+0245	A+0246	A+0247	A+0248	A+0249	A+0250	A+0251	A+0252	A+0253	A+0254	A+0255

# INTERFACE TYPE PC AT PS/2 ALT MODE OR USB-KEYBOARD ALT MODE (CONTINUED)

Table 39. Scancode Set When Control Character is 02

	x0	x1	x2	x3	x4	x5	x6	x7	x8	x9	xA	xB	xC	xD	xE	xF
0x	Ar↓	Ar↑	Al↓	Al↑	Cl↓	Cl↑	Cr↓	Cr↑	BS	Tab	→	S+ Tab	Enter Keyupd	Enter	Ins	Pg Up
1x	Pg Dwn	Home	←	↓	↑	F6	F1	F2	F3	F4	F5	ESC	F7	F8	F9	F10
2x	A+032	A+033	A+034	A+035	A+036	A+037	A+038	A+039	A+040	A+041	A+042	A+043	A+044	A+045	A+046	A+047
3x	A+048	A+049	A+050	A+051	A+052	A+053	A+054	A+055	A+056	A+057	A+058	A+059	A+060	A+061	A+062	A+063
4x	A+064	A+065	A+066	A+067	A+068	A+069	A+070	A+071	A+072	A+073	A+074	A+075	A+076	A+077	A+078	A+079
5x	A+080	A+081	A+082	A+083	A+084	A+085	A+086	A+087	A+088	A+089	A+090	A+091	A+092	A+093	A+094	A+095
6x	A+096	A+097	A+098	A+099	A+100	A+101	A+102	A+103	A+104	A+105	A+106	A+107	A+108	A+109	A+110	A+111
7x	A+112	A+113	A+114	A+115	A+116	A+117	A+118	A+119	A+120	A+121	A+122	A+123	A+124	A+125	A+126	A+127
8x	A+0128	A+0129	A+0130	A+0131	A+0132	A+0133	A+0134	A+0135	A+0136	A+0137	A+0138	A+0139	A+0140	A+0141	A+0142	A+0143
9x	A+0144	A+0145	A+0146	A+0147	A+0148	A+0149	A+0150	A+0151	A+0152	A+0153	A+0154	A+0155	A+0156	A+0157	A+0158	A+0159
Ax	A+0160	A+0161	A+0162	A+0163	A+0164	A+0165	A+0166	A+0167	A+0168	A+0169	A+0170	A+0171	A+0172	A+0173	A+0174	A+0175
Bx	A+0176	A+0177	A+0178	A+0179	A+0180	A+0181	A+0182	A+0183	A+0184	A+0185	A+0186	A+0187	A+0188	A+0189	A+0190	A+0191
Cx	A+0192	A+0193	A+0194	A+0195	A+0196	A+0197	A+0198	A+0199	A+0200	A+0201	A+0202	A+0203	A+0204	A+0205	A+0206	A+0207
Dx	A+0208	A+0209	A+0210	A+0211	A+0212	A+0213	A+0214	A+0215	A+0216	A+0217	A+0218	A+0219	A+0220	A+0221	A+0222	A+0223
Ex	A+0224	A+0225	A+0226	A+0227	A+0228	A+0229	A+0230	A+0231	A+0232	A+0233	A+0234	A+0235	A+0236	A+0237	A+0238	A+0239
Fx	A+0240	A+0241	A+0242	A+0243	A+0244	A+0245	A+0246	A+0247	A+0248	A+0249	A+0250	A+0251	A+0252	A+0253	A+0254	A+0255

## DIGITAL INTERFACE

Table 40. Scancode Set When Control Character is 00 or 01

	X0	X1	X2	X3	X4	X5	X6	X7	X8	X9	xA	xB	xC	xD	xE	xF
0x	NULL C+@	SOH C(S)+A	STX C(S)+B	ETX C(S)+C	EOT C+D	ENQ C(S)+E	ACK C(S)+F	BEL C(S)+G	BS	HT TAB	LF C(S)+J	VT C(S)+K	FF C(S)+L	CR Enter	SO C(S)+N	SI C(S)+O
1x	DLE C(S)+P	DC1 C(S)+Q	DC2 C(S)+R	DC3 C(S)+S	DC4 C(S)+T	NAK C(S)+U	SYN C(S)+V	ETB C(S)+W	CAN C(S)+X	EM C(S)+Y	SUB C(S)+Z	ESC Esc	FS C(S)+\	GS C+]	RS C(S)+^	US C(S)+_
2x	Space	!	“	#	\$	%	&	'	(	)	*	+	,	-	.	/
3x	0	1	2	3	4	5	6	7	8	9	:	;	<	=	>	?
4x	@	A	B	C	D	E	F	G	H	I	J	K	L	M	N	O
5x	P	Q	R	S	T	U	V	W	X	Y	Z	[	\	]	^	_
6x	,	a	b	c	d	e	f	g	h	i	j	k	l	m	n	o
7x	p	q	r	s	t	u	v	w	x	y	z	{		}	~	Del
8x		Sh↓	Sh↑	Ins	Ent (keyp)	F1	F2	F3	F4	F5	F6	F7	F8	F9	F10	F11
9x	F12	F13	F14	F15	F16	↑	↓	←	→					Cl↓	Cl↑	

Table 41. Scancode Set When Control Character is 02

	X0	X1	X2	X3	X4	X5	X6	X7	X8	X9	xA	xB	xC	xD	xE	xF
0x					Cl↓	Cl↑			BS	Tab	à	S+Tab	Enter Keypd	Enter	Ins	
1x			←	↓	↑	F6	F1	F2	F3	F4	F5	ESC	F7	F8	F9	F10
2x	Space	!	“	#	\$	%	&	'	(	)	*	+	,	-	.	/
3x	0	1	2	3	4	5	6	7	8	9	:	;	<	=	>	?
4x	@	A	B	C	D	E	F	G	H	I	J	K	L	M	N	O
5x	P	Q	R	S	T	U	V	W	X	Y	Z	[	\	]	^	_
6x	,	a	b	c	d	e	f	g	h	i	j	k	l	m	n	o
7x	p	q	r	s	t	u	v	w	x	y	z	{		}	~	Del

# IBM31XX 102-KEY

Table 42. Scancode Set When Control Character is 00 or 01

	x0	x1	x2	x3	x4	x5	x6	x7	x8	x9	xA	xB	xC	xD	xE	xF
0x	NULL C+@	SOH C(S)+A	STX C(S)+B	ETX C(S)+C	EOT C+D	ENQ C(S)+E	ACK C(S)+F	BEL C(S)+G	BS CAN C(S)+X	HT TAB EM C(S)+Y	LF C(S)+J SUB C(S)+Z	VT C(S)+K ESC Esc	FF C(S)+L FS C(S)+I	CR Enter GS C+]	SO C(S)+N RS C(S)+^	SI C(S)+O US C(S)+_
1x	DLE C(S)+P	DC1 C(S)+Q	DC2 C(S)+R	DC3 C(S)+S	DC4 C(S)+T	NAK C(S)+U	SYN C(S)+V	ETB C(S)+W								
2x	Space	!	“	#	\$	%	&	'	(	)	*	+	,	-	.	/
3x	0	1	2	3	4	5	6	7	8	9	:	;	<	=	>	?
4x	@	A	B	C	D	E	F	G	H	I	J	K	L	M	N	O
5x	P	Q	R	S	T	U	V	W	X	Y	Z	[	\	]	^	_
6x	,	a	B	c	d	e	f	g	h	i	j	k	l	m	n	o
7x	p	q	R	s	t	u	v	w	x	y	z	{		}		Del
8x		Sh↓	Sh↑	Ins	Ent (keyp)	F1	F2	F3	F4	F5	F6	F7	F8	F9	F10	F11
9x	F12	Enter	Reset	Insert	Delete	Field -	Field +	Enter paddle	Printl	Ar↓	Ar↑	Al↓	Al↑	Cl↓	Cl↑	Cr↓
Ax	Cr ↑															

Table 43. Scancode Set When Control Character is 02

	X0	x1	x2	x3	x4	x5	x6	x7	x8	x9	xA	xB	xC	xD	xE	xF
0x	Ar↓	Ar↑	Al↓	Al↑	Cl↓	Cl↑	Cr↓	Cr↑	BS	Tab	→	S+Tab	Enter Keyprd	Enter	Ins	Pg Up
1x	Pg Dwn	Home	←	↓	↑	F6	F1	F2	F3	F4	F5	ESC	F7	F8	F9	F10
2x	Space	!	“	#	\$	%	&	'	(	)	*	+	,	-	.	/
3x	0	1	2	3	4	5	6	7	8	9	:	;	<	=	>	?
4x	@	A	B	C	D	E	F	G	H	I	J	K	L	M	N	O
5x	P	Q	R	S	T	U	V	W	X	Y	Z	[	\	]	^	_
6x	,	a	B	c	d	e	f	g	h	i	j	k	l	m	n	o
7x	p	q	R	s	t	u	v	w	x	y	z	{		}		Del

# IBM XT

Table 44. Scancode Set When Control Character is 00 or 01

	X0	X1	X2	X3	X4	X5	X6	X7	X8	X9	xA	xB	xC	xD	xE	xF
0x	NULL C+@	SOH C(S)+A	STX C(S)+B	ETX C(S)+C	EOT C+D	ENQ C(S)+E	ACK C(S)+F	BEL C(S)+G	BS C(S)+H	HT TAB	LF C(S)+J	VT C(S)+K	FF C(S)+L	CR Enter	SO C(S)+N	SI C(S)+O
1x	DLE C(S)+P	DC1 C(S)+Q	DC2 C(S)+R	DC3 C(S)+S	DC4 C(S)+T	NAK C(S)+U	SYN C(S)+V	ETB C(S)+W	CAN C(S)+X	EM C(S)+Y	SUB C(S)+Z	ESC Esc	FS C(S)+[	GS C+]	RS C(S)+^	US C(S)+_
2x	Space	!	“	#	\$	%	&	'	(	)	*	+	,	-	.	/
3x	0	1	2	3	4	5	6	7	8	9	:	;	<	=	>	?
4x	@	A	B	C	D	E	F	G	H	I	J	K	L	M	N	O
5x	P	Q	R	S	T	U	V	W	X	Y	Z	[	\	]	^	_
6x	,	a	B	c	d	e	f	g	h	i	j	k	l	m	n	o
7x	p	q	R	s	t	u	v	w	x	y	z	{		}		Del
8x		Sh↓	Sh↑	Ins	Ent (keyp)	F1	F2	F3	F4	F5	F6	F7	F8	F9	F10	F11
9x	F12	Home	End	Pg Up	Pg Dwn	↑	↓	←	→	Ar↓	Ar↑	Al↓	Al↑	Cl↓	Cl↑	Cr↓
Ax	Cr↑															

Table 45. Scancode Set when Control Character 02

	X0	x1	x2	x3	x4	x5	x6	x7	x8	x9	xA	xB	xC	xD	xE	xF
0x	Ar↓	Ar↑	Al↓	Al↑	Cl↓	Cl↑	Cr↓	Cr↑	BS	Tab	→	S+Tab	Enter Keypd	Enter	Ins	Pg Up
1x	Pg Dwn	Home	←	↓	↑	F6	F1	F2	F3	F4	F5	ESC	F7	F8	F9	F10
2x	Space	!	“	#	\$	%	&	'	(	)	*	+	,	-	.	/
3x	0	1	2	3	4	5	6	7	8	9	:	;	<	=	>	?
4x	@	A	B	C	D	E	F	G	H	I	J	K	L	M	N	O
5x	P	Q	R	S	T	U	V	W	X	Y	Z	[	\	]	^	_
6x	,	a	B	c	d	e	f	g	h	i	j	k	l	m	n	o
7x	p	q	R	s	t	u	v	w	x	y	z	{		}		Del

# MICROSOFT WINDOWS CODEPAGE 1252

Windows-1252 is a character encoding of the Latin alphabet, used by default in the legacy components of Microsoft Windows in English and some other Western languages.

	00	01	02	03	04	05	06	07	08	09	0A	0B	0C	0D	0E	0F
00	NUL 0000	STX 0001	SOT 0002	ETX 0003	EOT 0004	ENO 0005	ACK 0006	BEL 0007	BS 0008	HT 0009	LF 000A	VT 000B	FF 000C	CR 000D	SO 000E	SI 000F
10	DLE 0010	DC1 0011	DC2 0012	DC3 0013	DC4 0014	NAK 0015	SYN 0016	ETB 0017	CAN 0018	EM 0019	SUB 001A	ESC 001B	PS 001C	GS 001D	RS 001E	US 001F
20	SP 0020	! 0021	" 0022	# 0023	\$ 0024	% 0025	& 0026	* 0027	( 0028	) 0029	* 002A	+ 002B	, 002C	- 002D	. 002E	/ 002F
30	0 0030	1 0031	2 0032	3 0033	4 0034	5 0035	6 0036	7 0037	8 0038	9 0039	: 003A	; 003B	< 003C	= 003D	> 003E	? 003F
40	@ 0040	A 0041	B 0042	C 0043	D 0044	E 0045	F 0046	G 0047	H 0048	I 0049	J 004A	K 004B	L 004C	M 004D	N 004E	O 004F
50	P 0050	Q 0051	R 0052	S 0053	T 0054	U 0055	V 0056	W 0057	X 0058	Y 0059	Z 005A	[ 005B	\ 005C	] 005D	^ 005E	_ 005F
60	` 0060	a 0061	b 0062	c 0063	d 0064	e 0065	f 0066	g 0067	h 0068	i 0069	j 006A	k 006B	l 006C	m 006D	n 006E	o 006F
70	p 0070	q 0071	r 0072	s 0073	t 0074	u 0075	v 0076	w 0077	x 0078	y 0079	z 007A	{ 007B	 007C	} 007D	~ 007E	DEL 007F
80	€ 20AC	• 20A2	ƒ 20A3	„ 20A6	… 20A8	† 20A9	‡ 20AA	ˆ 20AB	‰ 20AC	Š 20A1	‹ 20A2	Œ 20A3	• 20A4	Ž 20A5	• 20A6	• 20A7
90	• 20A8	ˆ 20A9	‰ 20AA	Š 20A1	‹ 20A2	Œ 20A3	• 20A4	Ž 20A5	• 20A6	• 20A7	• 20A8	• 20A9	• 20AA	• 20AB	• 20AC	• 20AD
A0	NEST 00A0	ı 00A1	ı 00A2	ı 00A3	ı 00A4	ı 00A5	ı 00A6	ı 00A7	ı 00A8	ı 00A9	ı 00AA	ı 00AB	ı 00AC	ı 00AD	ı 00AE	ı 00AF
B0	• 00B0	• 00B1	• 00B2	• 00B3	• 00B4	• 00B5	• 00B6	• 00B7	• 00B8	• 00B9	• 00BA	• 00BB	• 00BC	• 00BD	• 00BE	• 00BF
C0	À 00C0	Á 00C1	Â 00C2	Ã 00C3	Ä 00C4	Å 00C5	Æ 00C6	Ç 00C7	È 00C8	É 00C9	Ê 00CA	Ë 00CB	Ì 00CC	Í 00CD	Î 00CE	Ï 00CF
D0	Ð 00D0	Ñ 00D1	Ò 00D2	Ó 00D3	Ô 00D4	Õ 00D5	Ö 00D6	× 00D7	Ø 00D8	Ù 00D9	Ú 00DA	Û 00DB	Ü 00DC	Ý 00DD	Þ 00DE	ß 00DF
E0	à 00E0	á 00E1	â 00E2	ã 00E3	ä 00E4	å 00E5	æ 00E6	ç 00E7	è 00E8	é 00E9	ê 00EA	ë 00EB	ì 00EC	í 00ED	î 00EE	ï 00EF
F0	ø 00F0	ñ 00F1	ò 00F2	ó 00F3	ô 00F4	õ 00F5	ö 00F6	÷ 00F7	ø 00F8	ù 00F9	ú 00FA	û 00FB	ü 00FC	ý 00FD	þ 00FE	ÿ 00FF



# APPENDIX F

## ASCII CHART

---

ASCII Char.	Hex No.	ASCII Char.	Hex No.	ASCII Char.	Hex No.	ASCII Char.	Hex No.
NUL	00	SP	20	@	40	'	60
SOH	01	!	21	A	41	a	61
STX	02	"	22	B	42	b	62
ETX	03	#	23	C	43	c	63
EOT	04	\$	24	D	44	d	64
ENQ	05	%	25	E	45	e	65
ACK	06	&	26	F	46	f	66
BEL	07	'	27	G	47	g	67
BS	08	(	28	H	48	h	68
HT	09	)	29	I	49	i	69
LF	0A	*	2A	J	4A	j	6A
VT	0B	+	2B	K	4B	k	6B
FF	0C	,	2C	L	4C	l	6C
CR	0D	-	2D	M	4D	m	6D
SO	0E	.	2E	N	4E	n	6E
SI	0F	/	2F	O	4F	o	6F
DLE	10	0	30	P	50	p	70
DC1	11	1	31	Q	51	q	71
DC2	12	2	32	R	52	r	72
DC3	13	3	33	S	53	s	73
DC4	14	4	34	T	54	t	74
NAK	15	5	35	U	55	u	75
SYN	16	6	36	V	56	v	76
ETB	17	7	37	W	57	w	77
CAN	18	8	38	X	58	x	78
EM	19	9	39	Y	59	y	79
SUB	1A	:	3A	Z	5A	z	7A
ESC	1B	;	3B	[	5B	{	7B
FS	1C	<	3C	\	5C		7C
GS	1D	=	3D	]	5D	}	7D
RS	1E	>	3E	^	5E	~	7E
US	1F	?	3F	_	5F	DEL	7F



© 2011-2023 Datalogic S.p.A. and /or its affiliates • All rights reserved • Without limiting the rights under copyright, no part of this documentation may be reproduced, stored in or introduced into a retrieval system, or transmitted in any form or by any means, or for any purpose, without the express written permission of Datalogic S.p.A. and/or its affiliates • Datalogic and the Datalogic logo are registered trademarks of Datalogic S.p.A. in many countries, including the U.S. and the E.U.

 **DATALOGIC**  
[www.datalogic.com](http://www.datalogic.com)

**Datalogic S.r.l.**

Via S. Vitalino, 13 | 40012 Calderara di Reno | Bologna - Italy  
Tel. +39 051 3147011 | Fax +39 051 3147205



800000090

(Rev B)

May 2023