



LASER SENTINEL SERIES

Safety Laser Scanner

Stand Alone Model

QUICK GUIDE



*This Quick Reference Guide does not replace the Instruction Manual. Download the Instruction Manual by reading the QR code here or at www.datalogic.com. Click on **Support** > **Search by product** and enter the Laser Sentinel family name, then select your product from the dropdown list. Click on the **Manuals & Technical Literature** link to download your Instruction Manual. The Instruction Manual must be available at all times when installing and working with the product.*



SAFETY INFORMATION



For a correct use of the Laser Sentinel, the following points must be observed:

- The machine stopping system must be electrically controlled.
- This control system must be able to stop the dangerous movement of the machine within the total machine stopping time T and during all the working cycle phases.
- The device mounting and connections, must be carried out by qualified personnel only, according to the indications included in the special sections (refer to chapters 6 and 7 of the Instruction Manual) and in the applicable standards.
- The safety laser scanner must be securely placed in a particular position so that access to the dangerous zone is not possible without passing throughout the safety area (refer to chapter 5 of the Instruction Manual).
- The personnel operating in the dangerous area must be well trained and must have adequate knowledge of all the operating procedures of the safety laser scanner.
- In case of Manual Restart, the Restart button must be located outside the safety area to let the operator control the safety zone during resetting or testing sessions.
- Please carefully read the instructions for the correct functioning before powering the device.
- The requirements for the electrical safety and electromagnetic compatibility and the regulations or standards in all countries and/or regions, must be met by the power supply where the Laser Sentinel is used. If the Laser Sentinel power supply is shared with the machine or the other electronic devices, voltage reduction to the Laser Sentinel or noise influence to the device may occur due to the temporary increasing of the current consumption on the machine or the other electronic devices. We do not recommend sharing the Laser Sentinel power supply with the one for the machine or the other electronic devices, because the device may go to the error status in such circumstance.
- Do not place the connection cables in contact with or near high-voltage cables and/or cables with undergoing high current variations (e.g. motor power supplies, inverters, etc.).
- Do not connect any of the Laser Sentinel inputs to DC power sources outside of the declared range or to any AC power source, in order to avoid the risk of electric shock.
- Every access to the configuration tools must be allowed only to restricted and highly qualified personnel. The access to the configuration through the GUI is allowed only by password.

MECHANICAL MOUNTING

For mechanical mounting, the Laser Sentinel has two different procedures depending on the operation necessities. The two mounting possibilities are: direct mounting or angle adjustment bracket mounting (if the pitch and the roll angles need to be adjusted).

Optionally, the protection bracket can be added to applications using the angle adjustment brackets.



Required tool adjustable torque driver with 3 mm hex bit.

DIRECT MOUNTING

The device has two M5 threaded holes on the back and four M5 threaded holes on the side.

For direct mounting, use both M5 threaded holes in the back or all four M5 threaded holes on the two sides, taking into account the following values:

- M5 on the back (tightening torque 2.3 - 5.5 Nm), maximum depth of thread engagement 9.5 mm.
- M5 on the side (tightening torque 2.3 - 3 Nm), maximum depth of thread engagement 8 mm.



For direct mounting on the sides, if the wall or panel obstructs the output window, this plane cannot be used for safety zone monitoring. The safety zone must adhere to the minimum distance to wall value given in the Laser Sentinel Reference Manual.

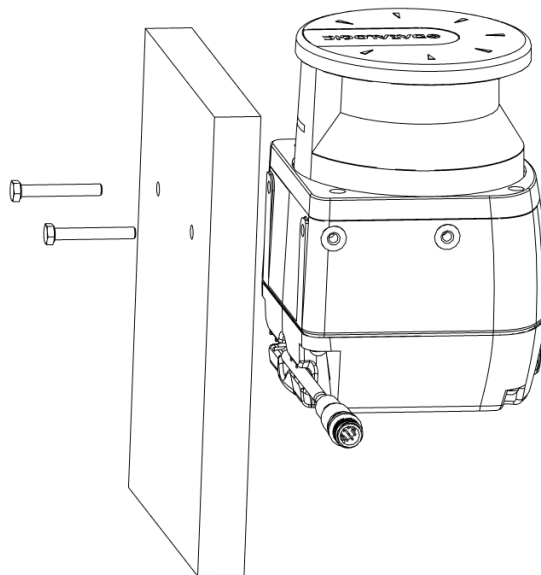

It is possible to mount the Laser Sentinel by employing a Bracket System. The Bracket System is not included in the Laser Sentinel package, it is an optional accessory. In this case make reference to the Bracket Manual and the Instruction Manual in order to install the device.

CONNECTIONS

All power connections to the Laser Sentinel must strictly comply with standard regulations. The device requires a supply voltage of 24 Vdc. Power must be supplied in accordance with SELV/PELV (IEC 60204-1) for all the devices electrically connected to the safety laser scanner. Make sure that the safety laser scanner is provided with an appropriate electrical fuse protection and the earthing system method is the same for all the devices connected to the Laser Sentinel.

MACHINE INTERFACE CONNECTIONS

The Laser Sentinel Stand Alone model has one OSSD pair and also includes three programmable signals. These signals allow the user to configure the device with different functions: the detection of a person or an object in the Warning Zone, the switching of the detection areas by employing external signals (Area Switch), the restart of the device caused by the OSSD Off-status (Restart) and restoring the device after a failure condition (Reset), the automatic deactivation of the safety status on the whole safety area (Muting) and the Single line pattern Muting Override used to force the safety function deactivation whenever it is necessary to restart the machine.



Make sure that the signals are aligned with the pin features and their specific function. In addition, they must be correctly connected to the external device.

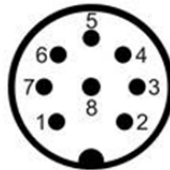

Power I/O Connector (M12 MALE 8-POLE)

TYPE	SIGNAL	COLOR	DESCRIPTION	PIN OUT
POWER	POWER SUPPLY	BROWN	24Vdc	2
	GND_ISO	BLUE	0 V	7
INPUT/OUTPUT	MULTI IN/OUT	GREEN	Selectable by GUI	3
	MULTI IN/OUT	YELLOW	Selectable by GUI	4
	MULTI IN/OUT	WHITE	Selectable by GUI	1
SAFETY OUTPUT	OSSD 1/1	GRAY	Safety Output	5
	OSSD 1/2	PINK	Safety Output	6
OTHER	F_EARTH	RED	Functional Earth	8

The **Multi In/Out** is a Pin that can be configured either as input or output.

SIGNAL	FUNCTION	CONNECTION
MULTI – IN	RESTART / RESET	
	AREA SWITCH	
	OVERRIDE (Single line pattern)	
	MUTING 1 MUTING 2	
	MUTING ENABLE	
MULTI – OUT	WARNING	
	MUTING LAMP	
OSSD	OSSD 1/1 OSSD 1/2	

SETUP AND CONFIGURATION



Download the DLSentinel GUI at www.datalogic.com. Click on **Support > Search by product** and enter the Laser Sentinel family name, then select your product from the dropdown list. Click on the **Software & Utilities** link to download your Graphic User Interface.

1. On the PC that will be used for configuration, (running Windows XP, 7, 8, or 10), download the DLSentinel.zip file. Extract the file, run the installation program and follow the installation procedure.
2. When the installation is complete the DLSentinel entry is created in the Start > All Programs menu under "Datalogic" as well as a desktop icon. Double-click the desktop icon to run it.
3. For the configuration procedure follow the steps included in the DLSentinel User's Manual.











Configuration to the connected device requires the alignment between the IP Addresses of the device and the computer LAN. For further information refer to the DLSentinel User's Manual.







MINIMUM SYSTEM REQUIREMENTS





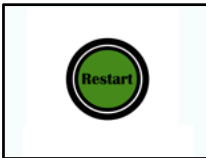

COMPONENT	RECOMMENDED	MINIMUM
Processor(s)	Pentium 4	Pentium 4
Clock frequency	>= 3 GHz	>= 2 GHz
RAM	2 GB	1 GB
Free hard drive space	70 MB	70 MB
Monitor resolution	1280x768	1024x768
Supporting Operating System	Windows XP Windows 7 Windows 8 Windows 10	





MONITORING BY DISPLAY

DISPLAYED ICON		NAME	DESCRIPTION
Configuration Valid	Configuration Pending Acceptance		
		ON State	The device is correctly functioning (OSSDs GO Condition). No presence detected in the Safety and Warning Area.
		Warning for Intrusion into Warning Zone	The device is correctly functioning. The device has detected a presence in the Warning Area.
		OFF State for Intrusion into Safety Zone	The device is correctly functioning (OSSDs STOP Condition). The device has detected a presence in the Safety Zone.
		OFF State for Reference Points	The device has detected that Reference Points have moved. The Display Sector in the direction of the moved reference point is lit in blue.

DIAGNOSTICS

Displayed Icon	Displayed Fault Code	Device Status	OSSD Status	Description/Action
	DLDNF	NORMAL	OFF	Downloading new firmware.
	DLDNC	NORMAL	OFF	Downloading new configuration.
	CLEANW2	NORMAL	ON	It is suggested to clean the window to avoid entering lockout condition.
	ITLOCK 1	NORMAL	OFF	Interlock. Waiting for the restart of OSSD.
	INTF6	NORMAL	ON	Non safety related internal test failure. Reset the system by using the reset function or cycle power to device. If failure persists, contact Datalogic Technical Support.
	EXTTEMP	NORMAL	ON	The device is operating in an environment that exceeds the specified operating temperature range: restore correct ambient temperature conditions.
	BOOTF	NORMAL	OFF	Invalid boot. Re-boot the system until the normal condition is restored. If warning persists, contact Datalogic Technical Support.
	MUT TIMEOUT	NORMAL	ON	Muting has expired because it is maintained beyond the maximum timeout time.

Displayed Icon	Displayed Fault Code	Device Status	OSSD Status	Description/Action
	MUTING ERR	NORMAL	ON	Muting has not activated because the correct sequence was not followed.
	MUTING	NORMAL	ON	The Muting function is active.
	OVERRIDE ERR	NORMAL	ON	Override has not been activated because the correct sequence has not been followed or there are no override conditions.
	OVERRIDE	NORMAL	ON	The Override function is active.
	OVERTEMP	NORMAL	ON	The unit is operating above or below its allowed operating temperature range.
	OVR TIMEOUT	NORMAL	ON	The Override timeout function has expired.
	CLEANW1	NORMAL	OFF	Window needs to be cleaned; repeat this action until the normal condition is restored. Otherwise damaged part must be replaced, contact Datalogic Technical Support.
	INPUTCF1	LOCKOUT	OFF	Check input connection or sequence.

Displayed Icon	Displayed Fault Code	Device Status	OSSD Status	Description/Action
	INPUTCF2	LOCKOUT	OFF	Check input sequence.
	OSSDF1	LOCKOUT	OFF	Check OSSD connections or integrity of the external switching device. If failure persists, contact Datalogic Technical Support.
		LOCKOUT	OFF	
	OSSD1F3	LOCKOUT	OFF	A short circuit to GND has been detected: check OSSD connections or integrity of the external switching device. If failure persists, contact Datalogic Technical Support.
	INTF1	LOCKOUT	OFF	Internal Failure. Reset the system by using the reset function or cycle power to device. If failure persists, contact Datalogic Technical Support.
	INTF2	LOCKOUT	OFF	
	INTF3	LOCKOUT	OFF	
	INTF4	LOCKOUT	OFF	
	INTF5	LOCKOUT	OFF	
	INTF7	LOCKOUT	OFF	
	INTF8	LOCKOUT	OFF	
	INTF9	LOCKOUT	OFF	
	INTF10	LOCKOUT	OFF	
	INTF11	LOCKOUT	OFF	
	INTF12	LOCKOUT	OFF	
	INTF13	LOCKOUT	OFF	
	INTF14	LOCKOUT	OFF	
	INTF15	LOCKOUT	OFF	
	INTF16	LOCKOUT	OFF	
	INTF17	LOCKOUT	OFF	
	INTF18	LOCKOUT	OFF	
	INTF20	LOCKOUT	OFF	

ORIGINAL INSTRUCTIONS (ref.)

Patents. See www.patents.datalogic.com for patents list.

Datalogic S.r.l.

Via S. Vitalino 13 - 40012 Calderara di Reno - Italy

Tel: +39 051 3147011 - Fax: +39 051 3147205 - www.datalogic.com

Helpful links at www.datalogic.com: Contact Us, Terms and Conditions, Support.

The warranty period for this product is 36 months. See General Terms and Conditions of Sales for further details.



Under current Italian and European laws, Datalogic is not obliged to take care of product disposal at the end of its life. Datalogic recommends disposing of the product in compliance with local laws or contacting authorised waste collection centres.

© 2017 - 2018 Datalogic S.p.A. and/or its affiliates ♦ ALL RIGHTS RESERVED. ♦ Without limiting the rights under copyright, no part of this documentation may be reproduced, stored in or introduced into a retrieval system, or transmitted in any form or by any means, or for any purpose, without the express written permission of Datalogic S.p.A. and/or its affiliates. Datalogic and the Datalogic logo are registered trademarks of Datalogic S.p.A. in many countries, including the U.S.A. and the E.U. All other trademarks and brands are property of their respective owners. Datalogic reserves the right to make modifications and improvements without prior notification.

821005590 Rev. A

END USER LICENSE AGREEMENT

NOTICE TO END USER: BY DOWNLOADING OR INSTALLING THE SOFTWARE, OR BY USING THE DATALOGIC PRODUCT THAT INCLUDES THIS SOFTWARE, THE END USER CONSENTS TO BE BOUND BY THIS AGREEMENT. IF THE END USER DOES NOT AGREE WITH ALL OF THE TERMS OF THIS AGREEMENT, THEN DATALOGIC IS NOT WILLING TO LICENSE THE SOFTWARE AND THE END USER IS NOT ALLOWED TO DOWNLOAD, INSTALL OR USE THE SOFTWARE OR THE DATALOGIC PRODUCT

This End User License Agreement ("EULA") is between Datalogic IP Tech S.r.l. having its registered office at Via San Vitalino 13, 40012 Calderara di Reno (Bologna), Italy ("Datalogic"), and you, either an individual or a single entity, ("End User or "You") who has purchased one or more Datalogic Laser Sentinel("Datalogic Product") subject to the terms and conditions provided in any relevant purchase or sale contract. This EULA applies to the software contained in the Datalogic Product ("Embedded Software") and to any other software, to the extent applicable, offered as optional application software ("Application Software" that together with "Embedded Software" is herein referred to as "Software").

1. Grant of License

1.1 Datalogic grants to End User, a personal, non-exclusive, non-transferable, non-sublicensable, revocable, limited license to use the Software, solely on the Datalogic Product in which it is embedded or for which it is intended for use, in machine-readable form only, solely for End User's internal business purposes.

1.2 End Users shall not distribute, sublicense, rent, loan, lease, assign, export, re-export, resell, ship or divert or cause to be exported, re-exported, resold, shipped or diverted, directly or indirectly, the Software under this Agreement. End User shall not, and shall not permit others to: (i) modify, translate, decompile, reverse engineer, disassemble, or extract the inner workings of the Software, (ii) copy the functionality of the Datalogic Products; (iii) remove any proprietary notices, marks, labels, or logos from the Datalogic Products; (iv) rent or transfer all or some of the Software to any other party without Datalogic's prior written consent.

1.3. Title to the licensed Software shall be and remain with Datalogic or the third party from whom Datalogic has obtained a license right. This Agreement does not grant to End User any intellectual property rights. As used in this Agreement the term "purchase" or its equivalent when applied to the Software shall mean "acquire under license". End User is not entitled to receipt or use of the source code of any licensed Software.

1.4 Portions of the Datalogic Product are protected by the relevant and applicable patent and copyright laws, international treaty provisions, and other applicable laws. Therefore, End User must treat the Datalogic Product like any other copyrighted material (e.g., a book or musical recording) except that End User may make one copy of the Software solely for back-up purposes. Unauthorized duplication of the Software constitutes copyright infringement.

1.5 Any use of the Software outside of the conditions set forth herein is strictly prohibited and will be deemed a breach of this Agreement resulting in immediate termination of this Agreement. In the event of a breach of this Agreement, Datalogic will be entitled to all available remedies at law or in equity (including but not limiting to immediate termination of the license without notice, immediate injunctive relief and repossession of all Datalogic Products).

1.6 Without prejudice of the foregoing, End User grants to Datalogic and its independent accountants or consultants the right to examine End User's books, records and accounts during End User's normal business hours to verify compliance with this Agreement. In the event such audit discloses non-compliance with this Agreement, Datalogic shall be entitled to immediately terminate the Agreement, request End User to promptly pay all (additional) license fees due and any further damages, if any.

2. License Fee

License fees shall be due by End User to Datalogic according to the terms provided for in the relevant contract for the purchase of the Datalogic Product.

3. Termination

Without prejudice to any other rights or remedies Datalogic may have, Datalogic may terminate this Agreement if End User fails to comply with the terms and conditions of this Agreement. Datalogic may terminate this Agreement by offering you a superseding Agreement for the Software or any replacement or modified version of or upgrade to the Software and conditioning your continued use of the Software or such replacement, modified or upgraded version on your acceptance of such superseding Agreement. In addition, either party may terminate this Agreement at any time. Subject to the foregoing, termination shall be effective upon notice to the other party. In the event that this Agreement terminates for any reason, End User's license to use the Software will immediately terminate, and End User must immediately stop using the Software, destroy all copies of the Software and all of its component parts, and, upon request, provide an affidavit certifying your compliance with the foregoing. The provisions of Sub-sections 1.2, 1.3, 1.4, 1.5, 4, 5, 6, 8, and 11 shall survive termination of this Agreement.

4. Limited Warranty

Datalogic warrants that, under normal use and operation, the Software will conform substantially to the applicable Datalogic Product documentation for the period specified in the same, provided that the Software is used with the Datalogic Product. Datalogic's entire liability and End User's sole and exclusive remedy for any breach of the foregoing limited warranty will be, at Datalogic's option, the provision of a downloadable patch or replacement software.

Datalogic does not warrant (i) that Software will meet End User's requirements; (ii) that Software will be uninterrupted or defect error free; (iii) any non conformity derived from unauthorized use, and/or improper installation or repair not in compliance with Datalogic Product documentation. End User agrees that the existence of such non conformities or errors and Datalogic's inability to remedy such errors shall not constitute a breach of this Agreement.

EXCEPT AS PROVIDED IN THIS AGREEMENT, THE DATALOGIC PRODUCT IS PROVIDED "AS IS" AND DATALOGIC MAKES NO WARRANTIES OF ANY KIND, EXPRESS OR IMPLIED, WRITTEN OR ORAL, WITH RESPECT TO THE DATALOGIC PRODUCT OR SOFTWARE, AND SPECIFICALLY DISCLAIMS THE IMPLIED WARRANTIES OF MERCHANTABILITY AND FITNESS FOR A PARTICULAR PURPOSE.

5. Limitation of Liability

EXCEPT AS PROVIDED IN THIS AGREEMENT, NEITHER DATALOGIC NOR ITS LICENSORS SHALL BE LIABLE FOR ANY CLAIMS AGAINST END USER BY ANY OTHER PARTY. IN NO EVENT SHALL DATALOGIC'S LIABILITY FOR DAMAGES, IF ANY, WHETHER BASED UPON CONTRACT, TORT (INCLUDING NEGLIGENCE), PRODUCT LIABILITY, STRICT LIABILITY, WARRANTY, OR ANY OTHER BASIS, EXCEED THE PRICE OR FEE PAID BY END USER FOR THE DATALOGIC PRODUCT. UNDER NO CIRCUMSTANCES SHALL DATALOGIC OR ITS LICENSORS BE LIABLE TO END USER OR ANY THIRD PARTY FOR LOST PROFITS, LOST DATA, INTERRUPTION OF BUSINESS OR SERVICE, OR FOR ANY OTHER SPECIAL, CONSEQUENTIAL, CONTINGENT, INDIRECT, INCIDENTAL, PUNITIVE, EXEMPLARY, OR OTHER SIMILAR DAMAGES, EVEN IF DATALOGIC OR ITS LICENSORS HAVE BEEN ADVISED OF THE POSSIBILITY OF SUCH DAMAGES. END USER MUST BRING ANY ACTION UNDER THIS AGREEMENT WITHIN 12 (TWELVE) MONTHS AFTER THE CAUSE OF ACTION ARISES.

6. Indemnification

To the maximum extent permitted by law, End User agrees to defend, indemnify and hold harmless Datalogic, its affiliates and their respective directors, officers, employees and agents from and against any and all claims, actions, suits or proceedings, as well as any and all losses, liabilities, damages, costs and expenses (including reasonable attorney's fees) arising out of or accruing from or related to Licensee's failure to comply with the terms of this Agreement, including but not limited to (1) non compliance with any applicable laws or regulations with Datalogic product documentation, (2) unauthorized use or disclosure of Software, and (3) use of Software in combination with software, hardware, systems, or other items not provided by Datalogic.

7. Support

End User may request support for Software from Datalogic at Datalogic's standard support fees and under Datalogic's standard support terms and conditions in effect at the time the support is requested.

8. Government Restricted Rights; International Use

8.1 Use, duplication, or disclosure of the Software by the U.S. Government is subject to the restrictions for computer software developed at private expense as set forth in the U.S. Federal Acquisition Regulations at FAR 52.227-14(g), or 52.227-19 or in the Rights in Technical Data and Computer Software clause at DFARS 252.227-7013(c)(1)(ii), whichever is applicable.

8.2 If End User is using the Datalogic Product outside of the United States, End User must comply with the applicable local laws of the country in which the Datalogic Product is used and with U.S. export control laws. Without prejudice of the foregoing, the End User agrees to not export or re-export the Software, any part thereof, or any process or service that is the direct product of the Software to any country, person or entity subject to U.S. export restrictions. End User specifically agrees not to export or re-export any of the Software: (i) to any country to which the U.S. has embargoed or restricted the export of goods or services or to any national of any such country, wherever located, who intends to transmit or transport the Software back to such country; (ii) to any person or entity who you know or have reason to know will utilize the Software in the design, development or production of nuclear, chemical or biological weapons; or (iii) to any person or entity who has been prohibited from participating in U.S. export transactions by any federal agency of the U.S. government. End User warrants and represents that neither the U.S. Commerce Department, Bureau of Export Administration nor any other U.S. federal agency has suspended, revoked or denied its export privileges.

9. Third Party Software

The Datalogic Product may contain one or more items of third party software which use is governed by separate third party license, unless otherwise stated.

10. Notices

All notices required or authorized under this Agreement shall be given in writing, and shall be effective when received, with evidence of receipt. Notices to Datalogic shall be sent to the attention of Datalogic IP Tech S.r.l., Legal & IP Department, Via San Vitalino 13, 40012 Calderara di Reno (Bologna), Italy, or such other address as may be specified by Datalogic in writing.

11. General Provisions.

11.1. Entire Agreement; Amendment. This document contains the entire agreement between the parties relating to use of the Datalogic Products and the licensing of the Software and supersedes all prior or contemporaneous agreements, written or oral, between the parties concerning the use of the Datalogic Products and licensing of the Software. This Agreement may not be changed, amended, or modified except by written document signed by Datalogic.

11.2. Waiver. A party's failure to enforce any of the terms and conditions of this Agreement shall not prevent the party's later enforcement of such terms and conditions.

11.3. Governing Law; Venue: End User agrees to the application of the laws of the country in which End User obtained the license to govern, interpret, and enforce all of End User's and Datalogic's respective rights, duties, and obligations arising from, or relating in any manner to, the subject matter of this Agreement, without regard to conflict of law principles. The United Nations Convention on Contracts for the International Sale of Goods does not apply.

All rights, duties, and obligations are subject to the courts of the country in which End User obtained the license. For licenses granted by Licensee who operates in the countries specified below, the following terms applies.

For Americas:

This Agreement is governed by the laws of the State of Oregon. This Agreement and the rights of the parties hereunder shall be governed by and construed in accordance with the laws of the State of Oregon U.S.A, without regard to the rules governing conflicts of law. The state or federal courts of the State of Oregon located in either Multnomah or Lane counties shall have exclusive jurisdiction over all matters regarding this Agreement, except that Datalogic shall have the right, at its absolute discretion, to initiate proceedings in the courts of any other state, country, or territory in which End User resides, or in which any of End User's assets are located. In the event an action is brought to enforce the terms and conditions of this Agreement, the prevailing party shall be entitled to reasonable attorneys' fees, both at trial and on appeal.

For Europe, Middle East and Africa:

This Agreement is governed by the laws of Italy. This Agreement and the rights of the parties hereunder shall be governed by and construed in accordance with the laws of Italy, without regard to the rules governing conflicts of law. Italian Court of Bologna shall have exclusive jurisdiction over all matters regarding this Agreement, except that Datalogic shall have the right, at its absolute discretion, to initiate proceedings in the courts of any other state, country, or territory in which End User resides, or in which any of End User's assets are located. In the event an action is brought to enforce the terms and conditions of this Agreement, the prevailing party shall be entitled to reasonable attorneys' fees, both at trial and on appeal.

For Asia- Pacific Countries:

The validity, interpretation and construction of the Agreement shall be governed by and construed in accordance with Laws of the Republic of Singapore. Parties expressly disclaim the application of the United Nations Convention for International Sale of Goods.

Any dispute arising out of or in connection with this contract, including any question regarding its existence, validity or termination, shall be referred to and finally resolved by arbitration administered by the Singapore International Arbitration Centre ("SIAC") in accordance with the Arbitration Rules of the Singapore International Arbitration Centre ("SIAC Rules") for the time being in force, which rules are deemed to be incorporated by reference in this clause. The seat of the arbitration shall be Singapore.

The number of arbitrators will be three, with each side to the dispute being entitled to appoint one arbitrator. The two arbitrators appointed by the parties will appoint a third arbitrator who will act as chairman of the proceedings. Vacancies in the post of chairman will be filled by the president of the SIAC. Other vacancies will be filled by the respective nominating party. Proceedings will continue from the stage they were at when the vacancy occurred. If one of the parties refuses or otherwise fails to appoint an arbitrator within 30 days of the date the other party appoints its, the first appointed arbitrator will be the sole arbitrator, provided that the arbitrator was validly and properly appointed. All proceedings will be conducted, including all documents presented in such proceedings, in the English

language. The English language version of these terms and conditions prevails over any other language version.

11.4. Attorneys' Fees. In the event an action is brought to enforce the terms and conditions of this Agreement, the prevailing party shall be entitled to reasonable attorneys' fees, both at trial and on appeal.

- END -

