

## QUICK GUIDE



*This Quick Reference Guide does not replace the Instruction Manual. Download the Instruction Manual by reading the QR code here or at [www.datalogic.com](http://www.datalogic.com). Click on **Support > Search by product** and enter the SG BWS family name, then select your product from the dropdown list. Click on the **Manuals & Technical Literature** link to download your Instruction Manual. The Instruction Manual must be available at all times when installing and working with the product.*



### SAFETY INFORMATION



*The following points must be observed for a correct and safe use of the safety light curtains of the SG-BWS-T4-MT series:*

The stopping system of the machine must be electrically controlled. This control system must be able to stop the dangerous movement of the machine within the total machine stopping time T as per par. 3.4 of the Instruction Manual and during all working cycle phases.

The safety system should be installed and connected by a qualified technician in compliance with the instructions specified in this manual and industry rules.

The photocells must be securely installed in a particular position so that access to the dangerous zone is not possible without the interruption of the beams (see 3.3 "General information on sensors positioning" of the Instruction Manual).

The personnel operating in the dangerous area must be well trained and must have adequate knowledge of all the operating procedures of the safety control unit.

The START and TEST buttons must be located outside the protected area because the operator must check the protected area during all Test and Reset operations.

Please carefully read the instructions for the correct functioning before powering the SG-BWS-T4-MT.

### Precautions to be observed for the choice and installation of the device



*Make sure that the protection level assured by the SG-BWS-T4-MT device (Type 4) is compatible with the real danger level of the machine to be controlled, according to EN 13849-1.*

- The outputs (SAFCN) of the ESPE must be used as machine stopping devices and not as command devices. The machine must have its own START command.
- The dimension of the smallest object to be detected must be larger than the resolution level of the installed safety sensors.

- The ESPE must be installed in a room complying with the technical characteristics indicated in section 9 “Technical data” of the Instruction Manual.
- Do not install the sensors close to strong and/or flashing light sources or close to similar devices.
- Strong electromagnetic disturbance might negatively affect device operation. Should this be the case contact Datalogic Technical Service.
- The operating distance of the safety sensors can be reduced in presence of smog, fog or airborne dust.
- A sudden change in environment temperature, with very low minimum peaks, can generate a small condensation layer on the sensors lenses and so jeopardise functioning.
- Pay special care when positioning the safety photocells so to offer effective protection. The safety sensors should be installed in such a way that the dangerous area can only be entered after detecting the sensitive area. Photocells position is fixed by normative and must respect measures in Tab. 4 of the Instruction Manual.



*The failure to respect the safety distance reduces or cancels ESPE the protection function. For more detailed information about calculation of safety distance, please refer to the Instruction Manual.*

## CONNECTIONS

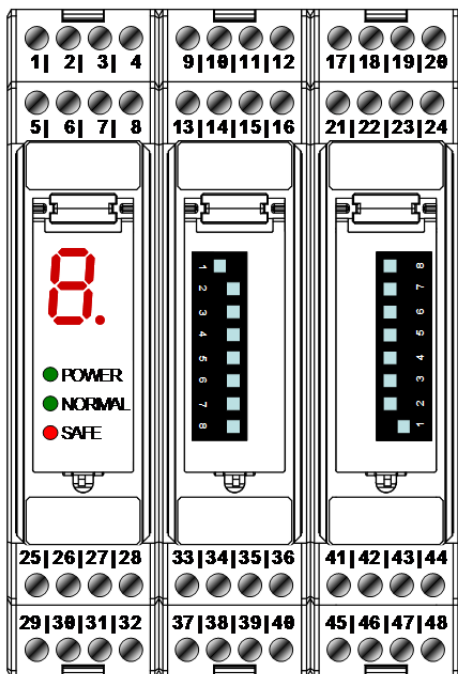

SIGNAL	CONTACT	CONNECTION	FUNCTION
VDC	1	24 Vdc ext.	Power
START	2	NO contact toward 24VDC	Reset Function
TEST/RESET	3	NC contact toward 24VDC	Test/Reset function
EDM	4	- NC contact of external relay toward 24 VDC (with EDM enabled) - NOT CONNECTED (with EDM disabled)	EDM Input
0 V	2	0 Vdc ext.	Power
MUTEN A	6	NO contact toward 24VDC	Muting enable
MUTEN B	7	NO contact toward 24VDC	Muting enable
DEFLAMP	8	Warning device positive terminal	Lamp failure warning
MUTA1	9	PNP output of muting sensor A1	Muting input
OVRA1	10	Override A1 NO contact toward 24VDC	Override input
MUTB1	11	PNP output of muting sensor B1	Muting input
OVRA1	12	Override B1 NO contact toward 24VDC	Override input
MUTA2	13	PNP output of muting sensor A2	Muting input
OVRA2	14	Override A2 NO contact toward 24VDC	Override input
MUTB2	15	PNP output of muting sensor B2	Muting input
OVRA2	16	Override B2 NO contact toward 24VDC	Override input
LAMPA-	17	Negative terminal of muting lamp A	Muting lamp output
LAMPA+	18	Positive terminal of muting lamp A	Muting lamp output
SAFNC11	19	Relays output NO 230V 1	Safety contact
SAFNC21	20		Safety contact
LAMPB-	21	Negative terminal of muting lamp B	Muting lamp output
LAMPB+	22	Positive terminal of muting lamp B	Muting lamp output
SAFNC12	23	Relays output NO 230V 2	Safety contact
SAFNC22	24		Safety contact
RX1	25	PNP output of receiver photocell 1 (black)	Photocell Input
RX2	26	PNP output of receiver photocell 2 (black)	Photocell Input
RX3	27	PNP output of receiver photocell 3 (black)	Photocell Input
RX4	28	PNP output of receiver photocell 4 (black)	Photocell Input
TX1	29	TEST of emitter photocell 1 (black)	Photocell Output
TX2	30	TEST of emitter photocell 2 (black)	Photocell Output
TX3	31	TEST of emitter photocell 3 (black)	Photocell Output
TX4	32	TEST of emitter photocell 4 (black)	Photocell Output
24VRX12	33	24VDC photocell receivers 1 and 2 (brown)	Power supply output
0VRX12	34	0VDC photocell receivers 1 and 2 (blue)	Power supply output
24VRX34	35	24VDC photocell receivers 3 and 4 (brown)	Power supply output
0VRX34	36	0VDC photocell receivers 3 and 4 (blue)	Power supply output
24VTX12	37	24VDC photocell emitters 1 and 2 (brown)	Power supply output
0VTX12	38	0VDC photocell emitters 1 and 2 (blue)	Power supply output
24VTX34	39	24VDC photocell emitters 3 and 4 (brown)	Power supply output

<b>SIGNAL</b>	<b>CONTACT</b>	<b>CONNECTION</b>	<b>FUNCTION</b>
0VTX34	40	0VDC photocell emitters 3 and 4 (blue)	Power supply output
OSSD11	41	OSSD 1 output of light curtain 1 (grey)	Safety light curtain input
OSSD21	42	OSSD 1 output of light curtain 2 (grey)	Safety light curtain input
24LRX12	43	24VDC light curtain receivers 1 and 2 (brown)	Power supply output
0LRX12	44	0VDC light curtain receivers 1 and 2 (brown)	Power supply output
OSSD12	45	OSSD 2 output of light curtain 1 (pink)	Safety light curtain input
OSSD22	46	OSSD 2 output of light curtain 2 (pink)	Safety light curtain input
24LTX12	47	24VDC light curtain emitters 1 and 2 (brown)	Power supply output
0LTX12	48	0VDC light curtain emitters 1 and 2 (brown)	Power supply output
<b>NO: Normally Open – NC: Normally Closed</b>			

**Minimum connection (1 photocell, no EDM, automatic RESTART)**

The control unit terminals layout and the minimum connection to check system operation are shown below.

The photocells set power (blue and brown wires) reaches terminals 33-34, 37-38 as specified in the table in the Instruction Manual.

For the other configuration (for example concerning muting and override) please refer to section 4 in the Instruction Manual.

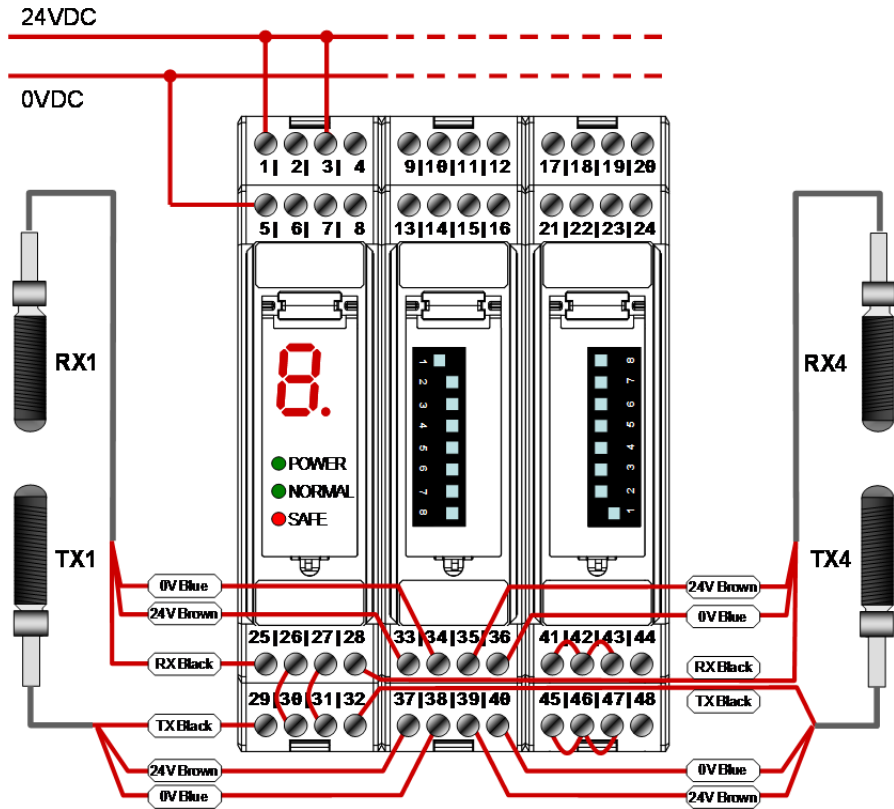

SIGNAL	CONTACT	CONNECTION	FUNCTION
VDC	1	24 Vdc ext.	Power
TEST/RESET	3	24 Vdc ext.	Test function
0 V	2	0 Vdc ext.	Power
RX1	25	PNP output of receiver photocell 1 (black)	Photocell Input
TX1	29	TEST of emitter photocell 1 (black)	Photocell Output
RX2	26	TX2 (30)	Photocell Input
RX3	27	TX3 (31)	Photocell Input
RX4	28	TX4 (32)	Photocell Input
OSSD11	41	OSSD21 (42)	Safety light curtain input
OSSD21	42	24LRX12 (43)	Safety light curtain input
OSSD12	45	OSSD22 (46)	Safety light curtain input
OSSD22	46	24LTX12 (47)	Safety light curtain input
24VRX12	33	24VDC power supply RX (brown)	Power supply output
0VRX12	34	0VDC power supply RX (blue)	Power supply output
24VTX12	37	24VDC power supply TX (brown)	Power supply output
0VTX12	38	0VDC power supply TX (blue)	Power supply output

**SG-BWS-T4-MT as MPCE (Machine Primary Control Equipment)**

SG-BWST-T4-MT can be directly used as a Machine Primary Control Equipment (MPCE) since it's equipped with internal monitored relays which can switch a maximum load of 3,6A at 250V. The proper connections are shown in the next figure.

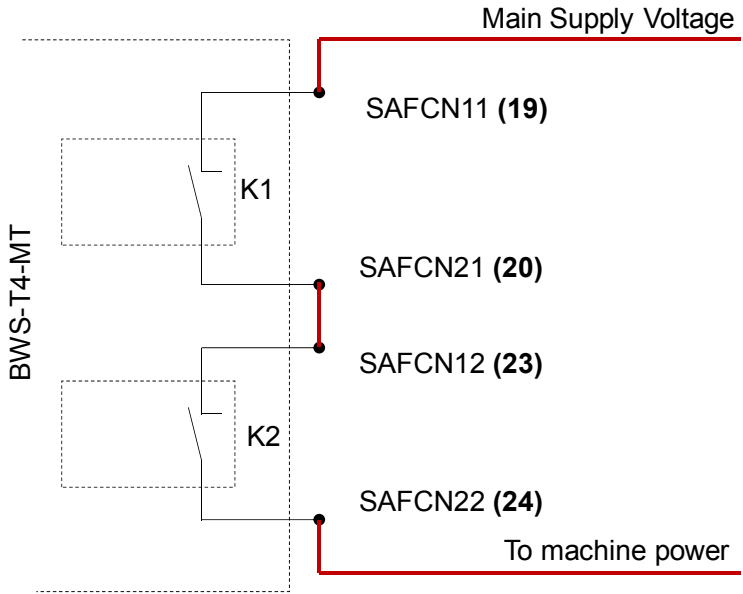

**SG-BWS-T4-MT as external safety relays controller**

When utilizing SG-BWS-T4 for external safety relays control proper connections are shown in the following figure.

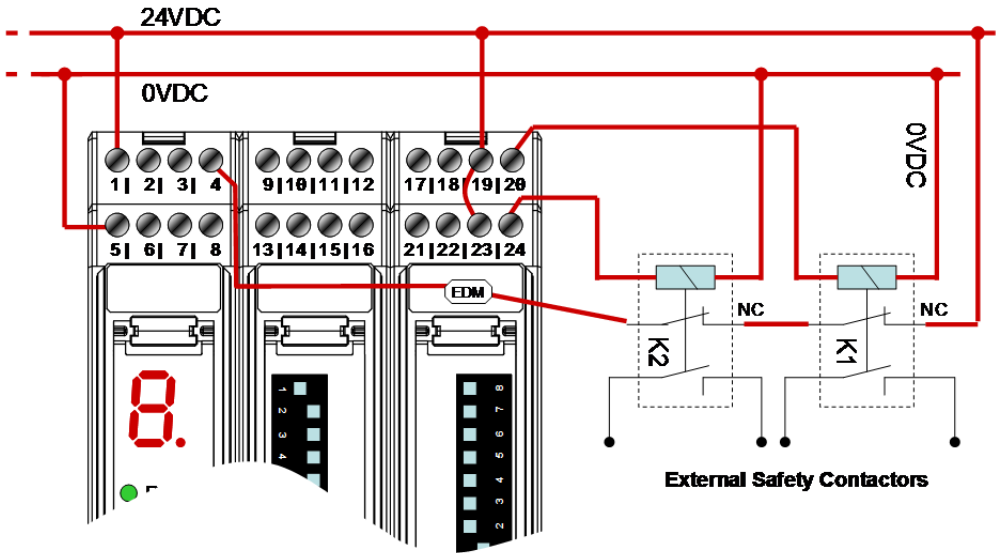

## ALIGNMENT SAFETY DEVICES

Once all components are in place and connected, emitters and receivers shall be mutually aligned. In alignment mode, the OSSD safety outputs are open. The alignment mode and relevant procedure are described here below:

- Cut off control unit power supply.
- Power on the control unit while holding pressed Test button (Test contact open)
- The 7-segment display shows the first device to be aligned (Photocells 1-4, light curtains 5-6)
- Align the indicated device until display will indicate the following device to be aligned or alignment completed warning (8 flashing).
- When alignment is completed, cut off control unit power, release Test push-button (close the contact) and restore control unit power.
- The control unit will run the initial test routines and display a countdown, the display will then turn off and the control unit will switch to NORMAL OPERATION status (● NORMAL).

### Now carry out the following inspections:

- The ESPE stays in ● SAFE mode during photocells and light curtains beam interruption using the suitable "Test Piece", along the entire protected area.
- Enabling the TEST function, the OSSD outputs should open (● SAFE and the controlled machine stops).
- The response time upon machine STOP (including response time of the ESPE and of the machine) is within the limits defined for the calculation of the safety distance (see section 3 "Installation" of the Instruction Manual).
- The safety distance between the dangerous areas and the safety sensors is in accordance with the instructions included in section 3 "Installation" of the Instruction Manual.
- Access of a person between sensors and machine dangerous parts is not possible nor is it possible for him/her to stay there.
- Access to the dangerous area of the machine from any unprotected area is not possible.

During alignment or normal operation, make sure that the photocells connected to the same or other units do not interfere with each other. Should you find interference, change their position, for instance you could set some emitter sets on the side of the other receivers. In case of interference, the control unit will lock out and display the relevant error code.

## DIP-SWITCHES CONFIGURATION

At control unit top part you will find two units made up of 8 Dip-Switches each: SG-BWS-T4-MT safety rating requires installation of two switches for setting up each function, so that **the setup defined for the first unit shall be set even for the second unit.**



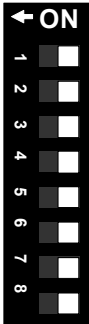





The table below is a list of possible settings selectable through the 8 Dip-Switches available.



DIP	PURPOSE	OFF (Default)	ON
1	ENABLE EDM	ENABLED	DISABLED
2	RESET MODE	AUTOMATIC	MANUAL
3	MUTING TIME-OUT	10 MINUTES	INFINITY
4	MUTING DIRECTION	T	L
5	TRIGGER OVERRIDE	LEVEL	FRONT
6	MUTING SELECTION	See the following chart.	
7	MUTING SELECTION		
8	MUTING SELECTION		

Datalogic supplies the control unit in the “Default” setup (all switches OFF).

The Dip-Switches 6-7-8 allow user to couple the single devices to the 2 muting channels available on the SG-BWS-T4-MT.

DIP-SWITCH SETUP	PHOTOCELLS		LIGHT CURTAIN 1	LIGHT CURTAIN 2
	PAIRS 1-2	PAIRS 3-4		
000 	A		A	A
001 	A		A	B
010 	A		B	B
011 	-		A	B
100 	A		B	-
101 	-		A	A
110 	A		-	-
111 	A	B	-	-

**0=OFF, 1=ON, A(B)=Device associated to channel A(B)**  
Default setting: **000**



*Activating a channel muting involves temporarily suspending the safety function of all devices associated to it. Extreme care is hence required when associating channel to devices: any dangerous settings shall be avoided.*













## DIAGNOSTICS AND SIGNALLING

SG-BWS-T4-MT is equipped with a user interface featuring 3 LEDs and a 7-segment display.



LED	INDICATION
● POWER	Device is powered correctly
● NORMAL	No danger: safety outputs closed
● SAFE	Danger or fault: safety outputs open
8.	The 7-segment display shows detailed information on control unit current status







### Normal operation signalling

INDICATION	STATUS	DESCRIPTION	TO DO
<ul style="list-style-type: none"> <li>● POWER</li> <li>○ NORMAL</li> <li>● SAFE</li> </ul> 	Alignment	The display shows the first device to be aligned and then the others in a sequence (1 to 6).	Align the safety devices 1..4: Photocells 5,6: Safety light curtains
<ul style="list-style-type: none"> <li>● POWER</li> <li>○ NORMAL</li> <li>● SAFE</li> </ul> 	Alignment	All connected devices are aligned.	Close the Test contact (Pin 3) and restart the control unit to switch to normal operation
<ul style="list-style-type: none"> <li>● POWER</li> <li>○ NORMAL</li> <li>● SAFE</li> </ul> 	SAFE	The indicated safety device beam is interrupted. If many devices are in this status, the first one is indicated, then the others in a sequence (1 to 6).	Clear the area or check device connections
<ul style="list-style-type: none"> <li>● POWER</li> <li>● NORMAL</li> <li>○ SAFE</li> </ul> 	NORMAL OPERATION	The device is in normal operating conditions and monitored area is safe.	
<ul style="list-style-type: none"> <li>● POWER</li> <li>● NORMAL</li> <li>○ SAFE</li> </ul> 	NORMAL OPERATION	The Muting function is active on channel A, B or both. The muting indicator is flashing.	
<ul style="list-style-type: none"> <li>● POWER</li> <li>● NORMAL</li> <li>○ SAFE</li> </ul> 	NORMAL OPERATION	The Muting function is active on channel A, B or both. The muting indicator is flashing.	

INDICATION	STATUS	DESCRIPTION	TO DO
<ul style="list-style-type: none"> <li>● POWER</li> <li>● NORMAL</li> <li>○ SAFE</li> </ul> 	NORMAL OPERATION	The Override function is active on channel A, B or both. The muting indicator is flashing.	
<ul style="list-style-type: none"> <li>● POWER</li> <li>● NORMAL</li> <li>○ SAFE</li> </ul> 	NORMAL OPERATION	One of the two muting lamps is disconnected or faulty (only one muting channel is active).	Change the faulty lamp. It is not necessary to restart.
<ul style="list-style-type: none"> <li>● POWER</li> <li>✱ NORMAL</li> <li>● SAFE</li> </ul> 	Interlock	Waiting for the START command in manual reset mode	Push reset control
<ul style="list-style-type: none"> <li>● POWER</li> <li>● I/O NORMAL</li> <li>○ / ● SAFE</li> </ul> 	NORMAL OPERATION/S AFE	The decimal point indicates that the EDM function is active (see 4.7)	
<ul style="list-style-type: none"> <li>● POWER</li> <li>○ NORMAL</li> <li>● SAFE</li> </ul> 	SAFE	TEST push-button pressed (contact 3 open)	Check TEST push-button connections (see 4.9)

### **Failure state signalling**

INDICATION	STATUS	DESCRIPTION	WHAT TO DO
<ul style="list-style-type: none"> <li>○ POWER</li> <li>○ NORMAL</li> <li>○ SAFE</li> </ul> 	Off	Power disconnected or inner fuse blown due to overload.	Check power supply. If error persists, please contact the Technical Service.
<ul style="list-style-type: none"> <li>● POWER</li> <li>○ NORMAL</li> <li>● SAFE</li> </ul> 	INTERNAL DEVICE MONITORING FAILURE LOCKOUT	Internal relays contacts monitoring test has failed.	Reset the control unit (see 4.6). If error persists, please contact the Technical Service.
<ul style="list-style-type: none"> <li>● POWER</li> <li>○ NORMAL</li> <li>● SAFE</li> </ul> 	INTERNAL OSSD FAILURE LOCKOUT	Internal OSSD test routine has failed.	Reset the control unit (see 4.9). If error persists, please contact the Technical Service.

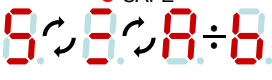
INDICATION	STATUS	DESCRIPTION	TO DO
<ul style="list-style-type: none"> <li>● POWER</li> <li>○ NORMAL</li> <li>● SAFE</li> </ul> 	EDM FAILURE LOCKOUT	EDM test has failed	Check EDM connections (see 4.7) or disable EDM function (see 4.4) if you do not wish to use it.
<ul style="list-style-type: none"> <li>● POWER</li> <li>○ NORMAL</li> <li>● SAFE</li> </ul> 	MICRO-PROCESSOR FAILURE LOCKOUT	One of microprocessor tests has failed	Disconnect power supply and reconnect it. If error persists, please contact the Technical Service.
<ul style="list-style-type: none"> <li>● POWER</li> <li>○ NORMAL</li> <li>● SAFE</li> </ul> 	DIP SWITCHES FAILURE LOCKOUT	The Dip-Switches setting consistency test has failed	Make sure that the settings of the two sets of switches is the same (see 4.4). Reset the control unit (see 4.9). If error persists, please contact the Technical Service.
<ul style="list-style-type: none"> <li>● POWER</li> <li>○ NORMAL</li> <li>● SAFE</li> </ul> 	RESTART FAILURE LOCKOUT	Start signal time-out tripped.	Make sure you hold the Start button depressed for less than 5s.
<ul style="list-style-type: none"> <li>● POWER</li> <li>○ NORMAL</li> <li>● SAFE</li> </ul> 	SENSOR FAILURE LOCKOUT	Test of indicated safety sensor has failed.	<ul style="list-style-type: none"> <li>- F 1-4: Make sure there is no interference across different photocell sets.</li> <li>- F 5-6: Check light curtains OSSD connections (see 4.5).</li> </ul>
<ul style="list-style-type: none"> <li>● POWER</li> <li>○ NORMAL</li> <li>● SAFE</li> </ul> 	LAMP FAILURE LOCKOUT	Muting lamp faulty or disconnected.	Change the faulty lamp, then Reset the control unit (see 4.9)
<ul style="list-style-type: none"> <li>● POWER</li> <li>○ NORMAL</li> <li>● SAFE</li> </ul> 	OVERRIDE FAILURE	The Override command activation test has failed (push-buttons not pressed at the same time)	Press the Override push-buttons at the same time.

## CE Compliance

CE marking states the compliance of the product with essential requirements listed in the applicable European directive. Since the directives and applicable standards are subject to continuous updates, and since Datalogic promptly adopts these updates, therefore the EU declaration of conformity is a living document. The EU declaration of conformity is available for competent authorities and customers through Datalogic commercial reference contacts. Since April 20th, 2016 the main European directives applicable to Datalogic products require inclusion of an adequate analysis and assessment of the risk(s). This evaluation was carried out in relation to the applicable points of the standards listed in the Declaration of Conformity. Datalogic products are mainly designed for integration purposes into more complex systems. For this reason it is under the responsibility of the system integrator to do a new risk assessment regarding the final installation.

**Warning:** This is a Class A product. In a domestic environment this product may cause radio interference in which case the user may be required to take adequate measures.

### Datalogic S.r.l.

Via S. Vitalino 13 - 40012 Calderara di Reno - Italy  
Tel: +39 051 3147011 - Fax: +39 051 3147205 - [www.datalogic.com](http://www.datalogic.com)

Helpful links at [www.datalogic.com](http://www.datalogic.com): **Contact Us, Terms and Conditions, Support.**

The warranty period for this product is 36 months. See General Terms and Conditions of Sales for further details.

 Under current Italian and European laws, Datalogic is not obliged to take care of product disposal at the end of its life. Datalogic recommends disposing of the product in compliance with local laws or contacting authorised waste collection centres.

© 2009 - 2017 Datalogic S.p.A. and/or its affiliates ♦ ALL RIGHTS RESERVED. ♦ Without limiting the rights under copyright, no part of this documentation may be reproduced, stored in or introduced into a retrieval system, or transmitted in any form or by any means, or for any purpose, without the express written permission of Datalogic S.p.A. and/or its affiliates. Datalogic and the Datalogic logo are registered trademarks of Datalogic S.p.A. in many countries, including the U.S.A. and the E.U. All other trademarks and brands are property of their respective owners. Datalogic reserves the right to make modifications and improvements without prior notification.

**830000503 Rev. D**