

 **DATALOGIC**

# Magellan™ 800i

On-Counter Presentation Omnidirectional  
Bar Code Reader



**Product Reference Guide**

**Datalogic USA, Inc.**

959 Terry Street  
Eugene, OR 97402  
USA

Telephone: (541) 683-5700

Fax: (541) 345-7140

© 2011-2017 Datalogic S.p.A. and its Group companies

An Unpublished Work - All rights reserved. No part of the contents of this documentation or the procedures described therein may be reproduced or transmitted in any form or by any means without prior written permission of Datalogic S.p.A. or its subsidiaries or affiliates ("Datalogic" or "Datalogic USA, Inc."). Owners of Datalogic products are hereby granted a non-exclusive, revocable license to reproduce and transmit this documentation for the purchaser's own internal business purposes. Purchaser shall not remove or alter any proprietary notices, including copyright notices, contained in this documentation and shall ensure that all notices appear on any reproductions of the documentation.

Should future revisions of this manual be published, you can acquire printed versions by contacting your Datalogic representative. Electronic versions may either be downloadable from the Datalogic website ([www.datalogic.com](http://www.datalogic.com)) or provided on appropriate media. If you visit our website and would like to make comments or suggestions about this or other Datalogic publications, please let us know via the "Contact Datalogic" page.

**Disclaimer**

Datalogic has taken reasonable measures to provide information in this manual that is complete and accurate, however, Datalogic reserves the right to change any specification at any time without prior notice.

Datalogic and the Datalogic logo are registered trademarks of Datalogic S.p.A. in many countries, including the U.S.A. and the E.U. All other brand and product names may be trademarks of Datalogic S.p.A. or of Datalogic Group companies, registered in many countries, including the U.S. and the E.U.

All other brand and product names may be trademarks of their respective owners.

Magellan is a trademark of Datalogic S.p.A. or of Datalogic Group companies, registered in many countries, including the U.S. and the E.U. All-Weighs, FirstStrike, SmartSentry, SurroundScan, and ScaleSentry are trademarks of Datalogic S.p.A. or of Datalogic Group companies, registered in the U.S.

**Patents**

See [www.patents.datalogic.com](http://www.patents.datalogic.com) for patent list.



# Table of Contents

<b>Chapter 1. GETTING STARTED</b> .....	<b>1</b>
<b>About This Manual</b> .....	<b>1</b>
Manual Conventions .....	1
<b>Connecting the Scanner</b> .....	<b>2</b>
<b>Programming</b> .....	<b>3</b>
Using the Programming Bar Codes .....	3
<b>Resetting the Standard Product Defaults</b> .....	<b>3</b>
<b>LED and Beeper Indicators</b> .....	<b>4</b>
<b>Error Codes</b> .....	<b>5</b>
<b>Chapter 2. GENERAL FEATURES</b> .....	<b>7</b>
<b>Double Read Timeout for Linear Labels</b> .....	<b>7</b>
<b>Double Read Queue</b> .....	<b>9</b>
<b>Double Read Timeout for 2D Labels</b> .....	<b>10</b>
<b>Sleep Mode</b> .....	<b>11</b>
<b>LED and Beeper Indicators</b> .....	<b>13</b>
Power On Alert .....	13
ERI Active State High .....	13
ERI Timeout .....	14
Good Read: When to Indicate .....	15
Good Read Beep Control .....	16
Good Read Beep Frequency .....	16
Good Read Beep Length .....	17
Good Read Beep Volume .....	18
<b>Scanning Features</b> .....	<b>19</b>
Wake Up Intensity .....	19
<b>Image Capture</b> .....	<b>21</b>
How to Capture an Image .....	21
Image Capture by Scanning a Special label .....	21
Image Capture to the Host by Host Command .....	21
Image Compression .....	22
Image Brightness .....	23
Image Contrast .....	23
<b>Cell Phone Mode</b> .....	<b>24</b>
Cell Phone Mode Sensitivity .....	25
<b>Chapter 3. INTERFACE RELATED FEATURES</b> .....	<b>27</b>
<b>Interface Selection</b> .....	<b>28</b>
<b>Interface Features</b> .....	<b>29</b>
Obey/Ignore Host Commands .....	29
Host Transmission Buffers .....	29
<b>RS-232 Interface Features</b> .....	<b>30</b>
Hardware Flow Control .....	32
Intercharacter Delay .....	33
Software Flow Control .....	34
Beep on ASCII BEL .....	34
Beep on Not on File .....	35
<b>ACK NAK Options</b> .....	<b>36</b>
ACK Character .....	37

NAK Character .....	37
Retry on ACK NAK Timeout .....	38
ACK NAK Timeout Value .....	38
ACK NAK Retry Count .....	38
ACK NAK Error Handling .....	39
Transmission Failure Indication .....	39
USB-OEM Interface Features .....	40
USB-OEM Device usage .....	40
USB Keyboard .....	40
Caps Lock State .....	43
Control Characters .....	44
Intercharacter Delay .....	45
<b>USB COM Interface Set-up .....</b>	<b>45</b>
<b>Chapter 4. DATA EDITING .....</b>	<b>47</b>
<b>Data Editing Overview .....</b>	<b>47</b>
Please Keep In Mind... .....	47
<b>Global Prefix/Suffix .....</b>	<b>48</b>
<b>AIM ID .....</b>	<b>49</b>
<b>Label ID .....</b>	<b>50</b>
<b>Case Conversion .....</b>	<b>56</b>
<b>Character Conversion .....</b>	<b>57</b>
<b>Chapter 5. SYMBOLOGIES .....</b>	<b>59</b>
<b>UPC-A .....</b>	<b>60</b>
Disable/Enable UPC-A .....	60
Check Digit Transmission .....	60
Expand UPC-A to EAN-13 .....	61
Number System Digit (NSD) Transmission .....	61
UPC-A Minimum Reads .....	62
UPC-A In-store Minimum Reads .....	62
<b>UPC-E .....</b>	<b>63</b>
Disable/Enable UPC-E .....	63
Check Digit Transmission .....	63
Number System Digit .....	64
Expand to UPC-E to UPC-A .....	64
Expand UPC-E to EAN13 .....	64
Minimum Reads .....	65
GTIN .....	65
Expand UPC/EAN to GTIN .....	65
<b>EAN-13 .....</b>	<b>66</b>
Disable/Enable EAN-13 .....	66
Check Digit Transmission .....	66
EAN-13 Flag 1 Character .....	66
ISBN .....	67
Minimum Reads .....	67
<b>EAN-8/JAN-8 .....</b>	<b>68</b>
Disable/Enable EAN-8/JAN-8 .....	68
Check Digit Transmission .....	68
Minimum Reads .....	69
<b>EAN Two-Label .....</b>	<b>70</b>
<b>EAN Two-Label Combined Transmission .....</b>	<b>70</b>
<b>Price Weight Check Digit .....</b>	<b>71</b>
<b>Add-ons .....</b>	<b>72</b>
2-Digit Addons Minimum Reads .....	73

5-Digit Addons Minimum Reads .....	74
<b>GS1 DataBar Omnidirectional .....</b>	<b>75</b>
(Stacked Omnidirectional) .....	75
Disable/Enable GS1 DataBar Omnidirectional .....	75
UCC/EAN 128 Emulation .....	75
Minimum Reads .....	76
<b>GS1 DataBar Expanded / Expanded Stacked .....</b>	<b>77</b>
Disable/Enable GS1 DataBar Expanded .....	77
GS1-128 Emulation .....	77
Length Control .....	78
GS1 DataBar Expanded Length 1, Length 2 Programming Instructions .....	78
Minimum Reads .....	79
Coupon Read Control .....	80
<b>GS1 DataBar Limited .....</b>	<b>81</b>
Disable/Enable GS1 DataBar Limited .....	81
GS1-128 Emulation .....	81
Minimum Reads .....	82
<b>Code 39 .....</b>	<b>83</b>
Disable/Enable Code 39 .....	83
Check Character Calculation .....	83
Check Character Transmit .....	84
Start/Stop Characters .....	84
Code 39 Full ASCII .....	85
Length Control .....	85
Code 39 Length 1, Length 2 Programming Instructions .....	86
Quiet Zones .....	86
Code 39 Stitching .....	87
Minimum Reads .....	87
<b>Code 32 Italian Pharmacode .....</b>	<b>88</b>
Disable/Enable Code 32 Italian Pharmacode .....	88
Start/Stop Characters .....	88
Check Character Transmit .....	89
<b>Code 128 .....</b>	<b>89</b>
Disable/Enable Code 128 .....	89
Disable/Enable EAN 128 .....	90
Transmit Function Characters .....	90
Length Control .....	91
Code 128 Length 1, Length 2 Programming Instructions .....	91
Code 128 Conversion to Code 39 .....	92
Code 128 Stitching .....	92
Minimum Reads .....	93
<b>Interleaved 2 of 5 .....</b>	<b>94</b>
Disable/Enable Interleaved 2 of 5 .....	94
Check Digit Calculation .....	94
Check Digit Transmit .....	95
Length Control .....	95
Interleaved 2 of 5 Length 1, Length 2 Programming Instructions .....	96
Interleaved 2 of 5 Stitching .....	96
Minimum Reads .....	97
<b>Codabar .....</b>	<b>97</b>
Disable/Enable Codabar .....	97
Check Character Verification .....	98
Check Character Transmit .....	98
Length Control .....	99
Codabar Length 1, Length 2 Programming Instructions .....	99

Quiet Zones .....	100
Start/Stop Character Type .....	100
Start/Stop Character Transmission .....	101
Start/Stop Character Match .....	101
Codabar Stitching .....	101
Minimum Reads .....	102
<b>Code 93 .....</b>	<b>103</b>
Disable/Enable Code 93 .....	103
Length Control .....	103
Code 93 Length 1, Length 2 Programming Instructions .....	104
Code 93 Stitching .....	104
Minimum Reads .....	105
<b>MSI/Plessey .....</b>	<b>105</b>
Disable/Enable MSI/Plessey .....	105
Check Digit Verification .....	106
Check Digit Transmit .....	106
Number of Check Characters .....	106
Length Control .....	107
MSI/Plessey Length 1, Length 2 Programming Instructions .....	107
MSI/Plessey Stitching .....	108
Minimum Reads .....	108
<b>Standard 2 of 5 .....</b>	<b>109</b>
Disable/Enable Standard 2 of 5 .....	109
Check Digit Verification .....	109
Check Digit Transmit .....	109
Length Control .....	110
Standard 2 of 5 Length 1, Length 2 Programming Instructions .....	110
Standard 2 of 5 Stitching .....	111
Minimum Reads .....	111
<b>Code 11 .....</b>	<b>112</b>
Disable/Enable Code 11 .....	112
Check Character Transmission .....	112
Length Control .....	113
Code 11 Length 1, Length 2 Programming Instructions .....	113
Minimum Reads .....	114
<b>Chapter 6. 2D SYBBOLOGIES .....</b>	<b>115</b>
<b>2D Sybologies .....</b>	<b>115</b>
PDF 417 .....	116
Disable/Enable PDF 417 .....	116
Length Control .....	116
PDF 417 Length 1, Length 2 Programming Instructions .....	117
Micro PDF 417 .....	118
Disable/Enable Micro PDF 417 .....	118
Length Control .....	118
Micro PDF 417 Length 1, Length 2 Programming Instructions .....	119
Datamatrix .....	120
Disable/Enable Datamatrix .....	120
Dot Matrix Datamatrix Labels .....	120
Length Control .....	120
Datamatrix Length 1, Length 2 Programming Instructions .....	122
QR Code .....	122
Disable/Enable QR Code .....	122
Length Control .....	123
QR Code Length 1, Length 2 Programming Instructions .....	124

---

Micro QR Code .....	124
Disable/Enable Micro QR Code .....	124
Maxicode .....	125
Disable/Enable Maxicode .....	125
Length Control .....	125
Maxicode Length 1, Length 2 Programming Instructions .....	126
Aztec .....	127
Disable/Enable Aztec .....	127
Length Control .....	127
Aztec Length 1, Length 2 Programming Instructions .....	128
Composite Labels .....	129
Disable/Enable GS1 DataBar Omnidirectional 2D Component .....	129
Disable/Enable GS1 DataBar Expanded 2D Component .....	129
Disable/Enable GS1 DataBar Limited 2D Component .....	130
<b>Chapter 7. ADVANCED DECODING FEATURES .....</b>	<b>131</b>
<b>Pharmacy Patterns .....</b>	<b>131</b>
<b>Inverse Label Reading .....</b>	<b>132</b>
<b>Chapter 8. REFERENCES .....</b>	<b>133</b>
<b>Global Prefix/Suffix .....</b>	<b>134</b>
<b>Label ID .....</b>	<b>135</b>
Length Control .....	136
Length 1, Length 2 Programming Instructions .....	136
<b>Appendix A. PRODUCT SPECIFICATIONS .....</b>	<b>137</b>
<b>Optical and Read Performance Parameters .....</b>	<b>137</b>
<b>Scanner Dimensions .....</b>	<b>138</b>
<b>Physical Properties .....</b>	<b>139</b>
<b>Electrical Parameters .....</b>	<b>139</b>
<b>Environmental Parameters .....</b>	<b>139</b>
<b>Other Parameters .....</b>	<b>139</b>
<b>Appendix B. CABLE PINOUTS .....</b>	<b>141</b>
<b>Standard Cable Pinouts (Primary Interface Cables) .....</b>	<b>141</b>
RS-232 .....	141
USB-OEM, USB Keyboard, USB COM & USB TEC .....	142
External Read Indicator (ERI) .....	142
<b>Appendix C. ALPHANUMERIC PAD .....</b>	<b>143</b>
Alphanumeric Pad .....	145
<b>Appendix D. DEFAULT SETTINGS .....</b>	<b>147</b>
<b>Defaults by Symbology .....</b>	<b>147</b>
<b>Interface Default Exceptions .....</b>	<b>149</b>
RS-232 Wincor/Nixdorf .....	149
USB Keyboards .....	149
<b>Appendix E. USB KEYBOARD FUNCTION KEY MAPPINGS.....</b>	<b>151</b>
USB Function Key Usage Map .....	151
<b>Appendix F. HOST COMMANDS.....</b>	<b>153</b>
<b>Host Commands Supported by RS-232 and USB COM Interfaces .....</b>	<b>153</b>

---

---

Appendix G. SAMPLE SYMBOLS.....	155
1D Symbol Samples .....	155
2D Sample Symbols .....	156
Composite Sample Symbols .....	157

# NOTES





# Chapter 1

## Getting Started

In stores where counter space is at a premium, the Magellan™ 800i Omni-Directional Imaging Scanner maintains an aggressive scan zone that is necessarily tight against the scanner's face. Scanning methods include a mixture of sweep and presentation styles, offering hands-free scanning for small, easily handled items and handheld scanning for bulkier objects.

### About This Manual

This manual presents advanced user information which includes connection, programming, product and cable specifications, and other useful references. For additional information, such as installation, maintenance, troubleshooting and warranty information, see the Quick Reference Guide (QRG). Copies of other publications for this product are downloadable free of charge from the website listed on the back cover of this manual.

On leaving the factory, units are programmed for the most common terminal and communications settings. If you need to change these settings, custom programming can be accomplished by scanning the bar codes in this guide. Bold text and a yellow-highlighted background indicates the most common default setting for a feature/option.

### Manual Conventions

The symbols listed below are used in this manual to notify the reader of key issues or procedures that must be observed when using the scanner:



**NOTE**

**Notes contain information necessary for properly diagnosing, repairing and operating the scanner.**



**CAUTION**

**The CAUTION symbol advises you of actions that could damage equipment or property.**

## Connecting the Scanner

The scanner kit you ordered to match your interface should provide a compatible cable for your installation. Use the appropriate instructions below to connect the scanner to the terminal, PC or other host device.

Upon completing the connection via the appropriate interface instructions below, proceed to the [Interface Related Features](#) section of this manual and scan the bar code to select the correct interface type.

**RS-232 Serial Connection** — Turn off power to the terminal/PC and connect the scanner to the terminal/PC serial port via the RS-232 cable as shown in [Figure 1](#). If the terminal will not support POT (Power Off the Terminal) to supply scanner power, use the approved power supply (AC Adapter). Plug the AC Adapter barrel connector into the socket on the RS-232 cable connector and the AC Adapter plug into a standard power outlet.

**Figure 1. RS-232 Serial Connection using A/C Adapter**

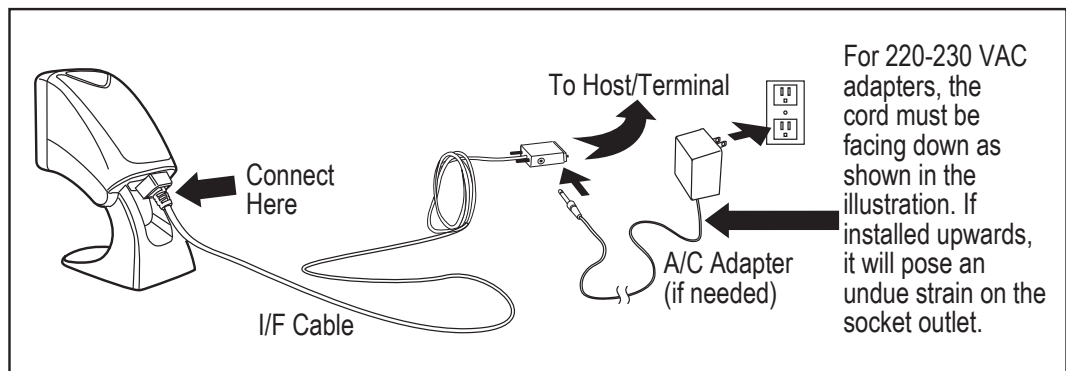

**USB Connection** — Connect the scanner to a USB port on the terminal/PC using the correct USB cable for the interface type you ordered. Reference [Figure 2](#).

**Figure 2. USB Connection**

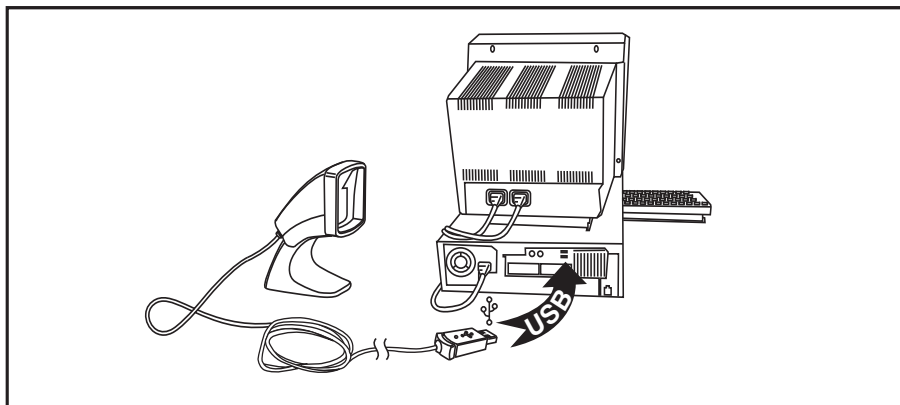

---

## Programming

The scanner is typically factory-configured with a set of default features standard to the interface type you ordered. After scanning the interface bar code from the [Interface Related Features](#) section, you can select other options and customize your scanner through use of the instructions and programming bar codes available in that section and also the [Data Editing](#) and [Symbologies](#) chapters of this manual.

### Using the Programming Bar Codes

This manual contains feature descriptions and bar codes which allow you to reconfigure your scanner. Some programming bar code labels, like the label below for resetting defaults, require only the scan of that single label to enact the change. Most of the programming labels in this manual, however, require the scanner to be placed in Programming Mode prior to scanning them. Scan a START/END bar code once to enter Programming Mode. Once the scanner is in Programming Mode, you can scan a number of parameter settings before scanning the START/END bar code a second time, which will then accept your changes, exit Programming Mode and return the scanner to normal operation.

### Resetting the Standard Product Defaults

If you are unsure of what programming options are in your scanner, or you've changed some options and want the factory settings restored, scan the *Standard Product Default Settings* bar code below. This will copy the factory configuration for the currently active interface to the current configuration.



Standard Product Default Settings

The programming section lists the factory default settings for each of the menu commands for the standard RS-232 interface in **BOLD** text on the following pages. Exceptions to default settings for the other interfaces can be found in [Appendix D, Default Settings](#).

## LED and Beeper Indicators

The scanner's beeper sounds and its green LED illuminates to indicate various functions or errors on the scanner. The tables below list these indications. One exception to the behaviors listed in the tables is that the scanner's functions are programmable, and may or may not be turned on. For example, certain indications, such as the power-up beep can be disabled using programming bar code labels.

LED INDICATION	INDICATION	COMMENT
Power-on indication	Bright green flash	Indicates the scanner has finished all its power up tests and is now ready for operation.
Good Read Indication	Bright green flash	Indicates a bar code has been read and decoded.
Scanner Ready	Constant dim green	The scanner is ready for operation.
Sleep Mode	Constant green flash (100mS on, 1900mS off)	The scanner is in Sleep Mode. To wake the scanner up, move an object in front of its window.
Host Disable	Constant green flash at 1 Hz (100mS on, 900mS off)	The scanner is disabled due to receiving a disable command from the POS terminal.
Diagnostics	Varies (see <a href="#">Error Codes on page 5</a> for more information)	The LED can provide diagnostic feedback if the scanner discovers a problem during SelfTest.
Prog. Mode	See <a href="#">Host Disable on page 4</a> above.	The scanner is in Programming Mode.

**Table 1BEEPER FUNCTIONS**

BEEPER INDICATION	INDICATION	COMMENT
Power On Beep	Single beep	The Power-On LED indication is a configurable feature which can be enabled or disabled. When enabled, this beep indicates the scanner has finished all its power up tests and is now ready for operation.
Good Read Indication	Single beep	The good read beep indication is configurable. Options include: Enable/disable, frequency, duration and volume. See the " <a href="#">LED and Beeper Indicators</a> " section on <a href="#">page 13</a> for more information.
Diagnostics	Varies (see <a href="#">Error Codes on page 5</a> for more information)	The Beeper can provide diagnostic feedback if the scanner discovers a problem during SelfTest.
Programming Mode Indications	Varies depending upon the feature(s) being configured.	The Beeper will sound as programming bar code labels are scanned, indicating progress during scanner configuration.

## Error Codes

Upon startup, if the scanner flashes its indicator LED or sounds an unexpected series of beep tones (other than normal power-up indications), this means the scanner has not passed its automatic Selftest and has entered FRU (Field Replaceable Unit) isolation mode. If the scanner is reset or the trigger is pulled, the sequence will be repeated. The following table describes the LED flashes / beep codes associated with an error found.

NUMBER OF LED FLASHES / BEEPS	ERROR	CORRECTIVE ACTION
1	Configuration	Contact Helpdesk for assistance
2	Interface	
6	System Controller	
12	Imager System	
13	Software ID Failure	

---





# NOTES



## Chapter 2 General Features

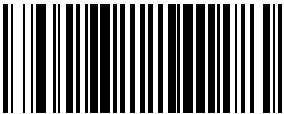



### Double Read Timeout for Linear Labels

This Double Read Timeout feature sets a time limit that determines how much time must pass before reading the same linear label again (e.g. two identical items in succession).

	START / END
PROGRAMMING BAR CODES	
0.1 Second	
	0.2 Second
0.3 Second	
	0.4 Second



**Double Read Timeout for Linear Labels — cont.**

0.5 Second	
	0.6 Second DEFAULT
0.7 Second	
	0.8 Second
0.9 Second	
	1 Second







## Double Read Queue

This feature controls the number of labels stored within the Double Read Time-out setting. This setting applies to Linear and 2D labels.



### NOTE









Setting this feature to 'one' may allow the reading of adjacent bar code labels within the scanner's field of view.

Double Read Queue = Seven DEFAULT	
	Double Read Queue = One



## Double Read Timeout for 2D Labels







This Double Read Timeout feature specifies the minimum allowable time between consecutive good reads of the same PDF 417, Micro PDF 417 Data Matrix, QR Code, Maxicode, Aztec or Composite label.

	20 mSec
40 mSec	
	1 Second DEFAULT
1.5 Seconds	
	1.65 Seconds
1.8 Seconds	
	1.95 Seconds
2 Seconds	











## Sleep Mode

This feature specifies the amount of time with no bar code reads before the scanner enters sleep mode.

	Disable Sleep Mode
15 Seconds	
	30 Seconds
1 Minute	
	2 Minutes
3 Minutes	
	4 Minutes
5 Minutes DEFAULT	
	6 Minutes



**Sleep Mode — cont.**

7 Minutes	
	8 Minutes
9 Minutes	
	10 Minutes
12 Minutes	
	15 Minutes
30 Minutes	
	1 Hour



## LED and Beeper Indicators

### Power On Alert

Disables or enables the indication (a single beep) that the scanner has finished all its power up tests and is now ready for operation.

Disable	
	Enable DEFAULT

### ERI Active State High

This setting specifies the active-state polarity of the External Read Indicator signal to High; the inactive state is the opposite polarity.

ERI Active State = Low	
	ERI Active State = High DEFAULT



## ERI Timeout

Specifies the amount of time the External Read Indicator (ERI) signal is held active for a good read.

Sets the ERI timeout duration using hex values from 000 to 255 in increments of ten milliseconds (10ms or 0.01 seconds). To configure this feature, scan the 'Enter/Exit Programming Mode' bar code above to place the unit in Programming Mode, then the 'Set ERI Timeout,' followed by the two digits (zero padded) from the Alphanumeric table in [Appendix C, Alphanumeric Pad](#) representing the desired time value. Exit programming mode by scanning the 'Enter/Exit Programming Mode' bar code again.

**DEFAULT SETTING FOR THIS FEATURE: 20 milliseconds (02)**



Set ERI Timeout



## Good Read: When to Indicate

This feature specifies when the scanner will provide indication (beep and/or flash its green LED) upon successfully reading a bar code. Choices are:

- Good Read = Indicate after decode
- Good Read = Indicate after transmit
- Good Read = Indicate after CTS goes inactive, then active



**NOTE**





This option (Indicate after CTS goes inactive, then active), which uses CTS, is only valid for RS-232 interfaces. If set to this mode in other interfaces, "Indicate after decode" mode will be assumed. This setting will only work if CTS Scan control is enabled.

- Good Read = Beep after each output structure proofed



**NOTE**

When beeping after each output structure decoded, if multiple output structures, there is a delay after the beep has finished. The delay is equal to the good beep length or can be set by a ULE script.

After Decode DEFAULT	
	After Transmit
After CTS goes inactive, then active	
	Beep after each output structure proofed





### Good Read Beep Control

This feature enables/disables the scanner's ability to beep upon a successful decode of a bar code.

Disable	
	Enable DEFAULT

### Good Read Beep Frequency

Adjusts the good read beep to sound at a selectable low, medium or high frequency, selectable from the list below. (Controls the beeper's pitch/tone.)









Low	
	Medium DEFAULT
High	





## Good Read Beep Length



Specifies the duration of a good read beep.

	30msec
40msec	
	50msec DEFAULT
60msec	
	80msec
100msec	
	120msec
140msec	
	160msec



## Good Read Beep Volume

Selects the beeper volume (loudness) upon a good read beep. There are three selectable volume levels.









Low	
	Medium
High DEFAULT	



## Scanning Features



### Wake Up Intensity

This feature indicates the percentage of ambient light change which will trigger the scanner to wake up from Sleep Mode. Lower settings provide greater sensitivity. The selectable range for this setting is 5% to 80%.

5%	
	10%
15%	
	20%
25% DEFAULT	
	30%
35%	
	40%



**Wake Up Intensity — cont.**

50%	
	60%
70%	
	80%



## Image Capture



### NOTE

Image capture requires that the scanner use the **Standard RS-232 or USB COM interface ONLY**.

The scanner reverts to normal reading mode after image capture and transfer.

## How to Capture an Image

By default, images are captured as 640 x 480 (VGA) format with a minimum compression ratio, and are displayed via the host application software. There are two methods of capturing images as discussed below:

- [Image Capture by Scanning a Special label](#)
- [Image Capture to the Host by Host Command](#)

### Image Capture by Scanning a Special label

To initiate an Image Capture, scan the IMAGE CAPTURE label below.



Upon scanning this label, the scanner's beeper will sound a "chirp" sequence and its LED's will flash rapidly for a time (nominally five seconds). At the end of this time, the scanner will capture the image and sound a rapid beep series. The scanner's LED's will then flash more slowly while data is being transmitted to the host. The beeper will then sound a final series of beeps to indicate the capture process is complete.

### Image Capture to the Host by Host Command

Image Capture is also available through Host commands. Refer to [Appendix F, Host Commands](#) for more information.





## Image Compression

Specifies the starting image compression factor for JPEG images. A higher number specifies a higher quality image with less compression than a relative lower number for the same image.

A value of 100 means minimal compression. A value of 1 means maximum compression at a loss of quality. Follow these steps to program this feature:

1. Scan the START bar code.
2. Scan the Set Image Compression bar code.
3. Turn to [Alphanumeric Pad](#) and scan the two digits (zero-padded) representing the desired compression. The configurable range is 01-0x64 by increments of 01.
4. Scan the END bar code.

	Image Compression = 30 (higher compression — lower quality)
Image Compression = 50 (medium compression — medium quality)	
	Image Compression = 100 (minimal compression — higher quality) DEFAULT



## Image Brightness

This feature sets the image brightness value. Follow these instructions to configure this feature:

1. Scan the START bar code.
2. Scan the Set Image Brightness bar code.
3. Turn to [Alphanumeric Pad](#) and scan the two digits (zero-padded) representing the desired brightness in decimal notation. The configurable range is 00–0x0A by increments of 01.
4. Scan the END bar code.



Set Image Brightness  
DEFAULT SETTING FOR THIS FEATURE: 00

## Image Contrast

This feature sets the image contrast value. Follow these instructions to configure this feature:

1. Scan the START bar code.
2. Scan the Set Image Contrast bar code.
3. Turn to [Alphanumeric Pad](#) and scan the two digits (zero-padded) representing the desired contrast in decimal notation. The configurable range is 00–0x0A by increments of 01.
4. Scan the END bar code.



Set Image Contrast  
DEFAULT SETTING FOR THIS FEATURE: 00



## Cell Phone Mode

Cell phone mode is when the scanner is enabled to read barcodes on a cell phone display. This mode is set as follows:

- Disabled – No cell phone mode
- Auto – Will automatically go to cell phone mode
- Manual – Will go to cell phone mode on receiving a command from the host. See [Appendix F, Host Commands](#) for more information regarding this feature.

	Cell Phone Mode = Disable DEFAULT
Cell Phone Mode = Auto	
	Cell Phone Mode = Manual





## Cell Phone Mode Sensitivity

When Cell Phone Mode is configured for “Auto” for a scanner, it will go into cell phone mode based on what is seen in its field of view. (The illumination LED’s will “flutter” slightly when entering cell phone mode.) By default, medium sensitivity is selected. If the scanner is going into cell phone mode more often than the user would like, the scanner can be set to low sensitivity by scanning the low sensitivity programming labels on the following page. If the scanner does not seem to go into cell phone mode often enough, the scanner can be set to high sensitivity by scanning the high sensitivity programming labels.

			Cell Phone Mode Sensitivity = Low Sensitivity SCAN ALL THREE BAR CODES
Cell Phone Mode Sensitivity = Medium Sensitivity DEFAULT SCAN ALL THREE BARCODES			



Enter/Exit Programming Mode

Cell Phone Mode

**Cell Phone Mode Sensitivity-cont.**



Cell Phone Mode Sensitivity = High Sensitivity  
SCAN ALL THREE BARCODES



## Chapter 3

# Interface Related Features

At the time of this writing, the reader supports the interfaces listed in . Select the desired interface type from the table, then reference the page number given for the customizable features section associated with each interface.

RS-232

[RS-232 Standard](#)

[RS-232 Wincor-Nixdorf](#)

USB

[USB-OEM](#)

[USB Keyboard](#)

[USB COM](#)

[USB TEC](#)





### NOTE

The correct interface cable is included for the reader interface type you ordered.



## Interface Selection

	RS-232 Standard
RS-232 Wincor-Nixdorf	
	USB-OEM
USB Keyboard	
	USB COM
USB TEC	



**NOTE**

Interface-specific settings are only valid for the active interface.



## Interface Features

### Obey/Ignore Host Commands

When set to ignore host commands, the scanner will ignore all host commands except for the minimum set necessary to keep the interface active and transmit labels. For normal operation of the interface, select Obey Host Commands.

	Obey Host Commands DEFAULT
Ignore Host Commands	

### Host Transmission Buffers









Specifies the number of host transmission(s) that may be buffered. By buffering data from a bar code, the scanner can continue to read a new bar code while the old one is being transmitted to the host. Selecting BUFFERS = 1 means that the first bar code must be transmitted before a new one can be read. A selection of BUFFERS = 2 means that a new bar code can be read while data from the first bar code is transmitted.

When a DISABLE SCANNER command is received from the host, the scanner will continue to transmit all data that is buffered.

	Host Transmission Buffers = 1
Host Transmission Buffers = 2 DEFAULT	









## RS-232 Interface Features

	1200 Baud
2400 Baud	
	4800 Baud
9600 Baud DEFAULT	
	19200 Baud
38400 Baud	
	57600 Baud
115200 Baud	



## RS-232 Interface Features - cont

	7 Data Bits
8 Data Bits DEFAULT	
	1 Stop Bit DEFAULT
2 Stop Bits	
	Parity = None DEFAULT
Parity = Even	
	Parity = Odd



### Hardware Flow Control

**Disable Hardware Control** — The scanner transmits to the host regardless of any activity on the CTS line.

**Enable CTS Flow Control** — The CTS signal controls transmission of data to the host.

**Enable CTS Scan Control** — The CTS line must be active for the scanner to read and transmit data. While the CTS line is inactive, the scanner remains in a host-disabled state; following a successful label transmission, the CTS signal must transition to inactive and then to active to enable scanning for the next label.

**Enable CTS Scan Control - No Toggle** — This feature works the same as CTS scan control, except the CTS toggle at the end of transmission is not required.

	Disable Hardware Control DEFAULT
Enable CTS Flow Control	
	Enable CTS Scan Control
Enable CTS Scan Control - No Toggle	





### Intercharacter Delay

Specifies a delay between the end of one character and the beginning of the next in 10-millisecond increments. This delay is inserted after each data character transmitted. If the transmission speed is too high, the system may not be able to receive all characters. You may need to adjust the delay to make the system work properly.

	Inter-Char Delay = No Delay DEFAULT
Interchar Delay = 10 msec	
	Interchar Delay = 20 msec
Interchar Delay = 30 msec	
	Interchar Delay = 40 msec
Interchar Delay = 50 msec	
	Interchar Delay = 60 msec
Interchar Delay = 70 msec	



### Intercharacter Delay — cont.

	Interchar Delay = 80 msec
Interchar Delay = 90 msec	

### Software Flow Control

Disables/Enables software control using XON/XOFF characters.

	Disable Software Flow Control DEFAULT
Enable Software Flow Control	

### Beep on ASCII BEL



Enables/disables ability of scanner to beep (sound a good read tone) on receiving an ASCII BEL (07 hex).

	Disable Beep on ASCII BEL DEFAULT
Enable Beep on ASCII BEL	



## Beep on Not on File

Enables the scanner to cause beep to be sounded on receiving not-on-file (NOF) command.





	Beep on Not On File = Disable
Beep on Not On File = Low Volume DEFAULT	
	Beep on Not On File = Medium Volume
Beep on Not On File = High Volume	



## ACK NAK Options

This enables/disables the ability of the scanner to support the RS-232 ACK NAK protocol. When configured, the scanner and/or host sends an “ACK” when it receives data properly, and sends “NAK” when the data is in error. Selections for this option are:

- Disable
- Enable for label transmission — the scanner expects an ACK/NAK response from the host when a label is sent
- Enable for host-command acknowledge — the scanner will respond with ACK NAK when the host sends a command
- Enable for label transmission and host-command acknowledge

	Disable ACK NAK DEFAULT
Enable ACK NAK for Transmission	
	Enable ACK NAK for host command acknowledge
Enable ACK NAK for transmission and host command acknowledge	



## ACK Character



### NOTE

Setting to previously defined characters such as XON, XOFF, or host commands conflicts with normal operation of these characters; 8-bit data is not recognized when the Number of Data Bits = 7 ASCII characters or any hex value from 0 to FF.

Sets the ACK character from the set of ASCII characters or any decimal value from 000 to 255. Pad entries of less than three digits with zeros, as in '005". To configure this feature, scan the 'Enter/Exit Programming Mode' bar code above to place the unit in Programming Mode, then the 'Set ACK Character," followed by the digits from the Alphanumeric table in [Appendix C, Alphanumeric Pad](#) representing your desired character. Exit programming mode by again scanning the 'Enter/Exit Programming Mode' bar code above.

**DEFAULT SETTING FOR THIS FEATURE: 006**



Set ACK Character

## NAK Character



### NOTE

Setting to previously defined characters such as XON, XOFF, or host commands conflicts with normal operation of these characters; 8-bit data is not recognized when the Number of Data Bits = 7 ASCII characters or any hex value from 0 to FF.

Sets the NAK character from the set of ASCII characters or any decimal value from 000 to 255. Pad entries of less than three digits with zeros, as in '005". To configure this feature, scan the 'Enter/Exit Programming Mode' bar code above to place the unit in Programming Mode, then the 'Set NAK Character," followed by the digits from the Alphanumeric table in [Appendix C, Alphanumeric Pad](#) representing your desired character. Exit programming mode by again scanning the 'Enter/Exit Programming Mode' bar code above.

**DEFAULT SETTING FOR THIS FEATURE: 021**



Set NAK Character



### Retry on ACK NAK Timeout

Specifies the action the scanner performs after the configurable ACK NAK Timeout Value (set in the following feature) has expired.

	Disable Retry on ACK NAK Timeout (Transmission failure occurs)
Enable Retry on ACK NAK Timeout DEFAULT	

### ACK NAK Timeout Value

This item specifies the time the scanner will wait for an ACK character from the host following a label transmission.  
 00 = Infinite timeout  
 01 - 75 = Timeout in 200-millisecond increments  
 To configure this feature, scan the 'Enter/Exit Programming Mode' bar code above to place the unit in Programming Mode, then the 'Set ACK NAK Timeout Value 'Enter/Exit Programming Mode,'" followed by the two digits (zero padded) from the Alphanumeric table in [Appendix C, Alphanumeric Pad](#) representing your desired value. Exit programming mode by again scanning the 'Enter/Exit Programming Mode' bar code above.  
**DEFAULT SETTING FOR THIS FEATURE: 01 (200 msec)**

	Set ACK NAK Timeout Value
--	---------------------------

### ACK NAK Retry Count

This feature sets the number of times for the scanner to retry a label transmission under a retry condition.  
 000 = No retry  
 001 - 254 = Retry for the specified number of times  
 255 = Retry forever  
 To configure this feature, scan the 'Enter/Exit Programming Mode' bar code above to place the unit in Programming Mode, then the 'Set ACK NAK Retry Count,'" followed by the three digits (zero padded) from the Alphanumeric table in [Appendix C, Alphanumeric Pad](#) representing your desired retry count. Exit programming mode by again scanning the 'Enter/Exit Programming Mode' bar code above  
**DEFAULT SETTING FOR THIS FEATURE: 003**



	Set ACK NAK Timeout Value
--	---------------------------



### ACK NAK Error Handling



This item specifies the method the scanner will use to handle errors detected while waiting to receive the ACK character from the host. Errors include unrecognized host commands and communication errors such as parity or framing errors. Choices are:

- 00 = Ignore errors detected (recommended setting)
- 01 = Process error as valid ACK character (risk of lost label data)
- 02 = Process error as valid NAK character (risk of duplicate label data)

	<b>Ignore Errors Detected DEFAULT</b>
Process error as valid ACK character	
	Process error as valid NAK character

### Transmission Failure Indication

Enables/disables bad-label indication upon transmission failure.

	Disable Transmission Error Indication
<b>Enable Transmission Error Indication DEFAULT</b>	



## USB-OEM Interface Features

### USB-OEM Device usage

The USB-OEM protocol allows for the scanner to be identified as one of two different types of bar code scanners. Changing this value from the factory setting may be necessary when connecting two of the same scanner type to a POS system.

Options are:

- Table Top Scanner
- Handheld Scanner

	Configure as Table Top Scanner DEFAULT
Configure as Handheld Scanner	

## USB Keyboard

As a USB keyboard interface, the scanner supports most popular PCs and IBM terminals. The installation is a fairly simple process that doesn't require any changes of software or hardware.









### Keyboard Layout

The Keyboard Layout option supports many countries. For details about Keyboard Layout, please refer to your operating system manual.

	USA DEFAULT
Belgium	
	Britain





<b>USB Keyboard — cont.</b>	
Denmark	
	France
Germany	
	Italy
Norway	
	Portugal
Spain	
	Sweden
Switzerland	



**USB Keyboard — cont.**

	Japan 106 Key
Hungary	
	Czech Republic
Slovakia	
	Romania
Croatia	
	Poland



## Caps Lock State

Choices are:

**CAPS LOCK Off** — send character data in normal format

**CAPS LOCK ON** — send character data in reverse case.

**SHIFT-LOCK MODE** — send character data in shifted case. This only applies to Wedge G. For other interface this setting results in a CAPS LOCK Off functionality.

**CAPS LOCK COMPENSATION MODE** — Preserves the case of the character data by detecting the state of the CAPS LOCK.

	Caps Lock State = Caps Lock Off DEFAULT
Caps Lock State = ON	
	Caps Lock State = Caps Lock Compensation Mode

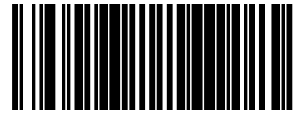



## Control Characters

Affects suffix and prefix characters. When disabled, only ASCII characters between 20H and 127H inclusive (space... delete) plus special characters 0DH (carriage return), 08H (backspace), 27H (ESC), 09H (right tab) and 0BH (left tab) are transmitted.

Choices are:

- Disable Control Characters
- Enable transmission of control characters to host
- Send characters between 00H and 1FH according to a special function–key mapping table. (This is used to send keys that are not in the normal ASCII set; a unique set is provided for each available scancode set. Reference [Appendix E, USB Keyboard Function Key Mappings.](#))

	<b>Disable Control Characters</b> <b>DEFAULT</b>
Enable Transmission of Control Characters	
	Enable Function Key Mapping



### Intercharacter Delay

- If the transmission speed is too high, the system may not be able to receive all characters. You may need to adjust the delay to make the system work properly. Selectable from 00 to 99.

USB Keyboard: 00 = 1 ms USB Host poll rate. Non-zero values less than 25 are 10 ms increments in USB Host poll rate values greater than 25 result in a USB Host poll rate of 255 ms.

To configure this feature, scan the 'Enter/Exit Programming Mode' bar code above to place the unit in Programming Mode, then the "Set Intercharacter Delay," followed by the two digits (zero padded) from the Alphanumeric table in [Appendix C, Alphanumeric Pad](#) representing your desired length. Exit programming mode by again scanning the 'Enter/Exit Programming Mode' bar code above/

DEFAULT SETTING FOR THIS FEATURE:

01



Set Intercharacter Delay

## USB COM Interface Set-up

To set the reader to use the USB Com interface, follow these instructions:

1. Download and install the USB Com driver available from the [www.data-logic.com](http://www.data-logic.com) website.
2. Program the reader for the USB Com interface using the bar code located on page 28.

---

# NOTES



# Chapter 4 Data Editing

## Data Editing Overview



### CAUTION

These features are not supported by the USB-OEM interface.

When a bar code is scanned, additional information can be sent to the host computer along with the bar code data. This combination of bar code data and supplementary user-defined data is called a “message string.” The features in this chapter can be used to build specific user-defined data into a message string.

There are several types of selectable data characters that can be sent before and after scanned data. You can specify if they should be sent with all symbologies, or only with specific symbologies. Figure 1 shows the available elements you can add to a message string:

Figure 1. Breakdown of a Message String

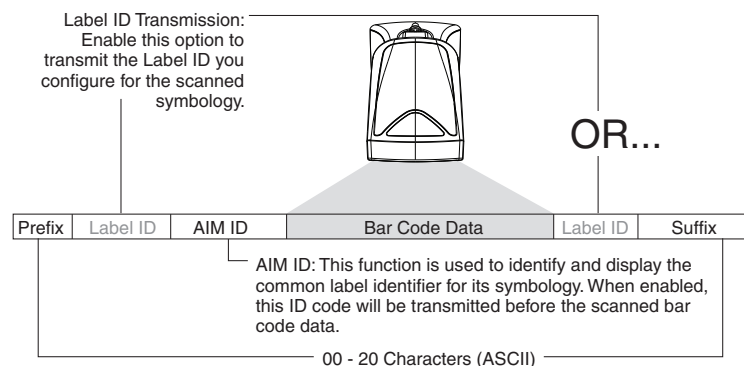

## Please Keep In Mind...

- Modifying a message string is not a mandatory requirement. Data editing is sophisticated feature allowing highly customizable output for advanced users. Factory default settings for data editing is typically set to NONE.



- A prefix or suffix may be applied (reference the [Symbologies](#) chapter for these settings) across all symbologies (set via the Global features in this chapter).
- You can add any character from the [ASCII Character Set on page 159](#) (from 00–7F) on the inside back cover of this manual as a prefix, suffix or Label ID.
- Enter prefixes and suffixes in the order in which you want them to appear on the output.

## Global Prefix/Suffix

Sets up to 20 characters each from the set of ASCII characters or any hex value from 00 to 7F. To configure this feature, scan the 'Enter/Exit Programming Mode' bar code above to place the unit in Programming Mode, then the 'Set Prefix' or 'Set Suffix,' followed by the digits from the Alphanumeric table in [Appendix C, Alphanumeric Pad](#) representing your desired character(s). Reference the section, [Global Prefix/Suffix on page 134](#), for more information. Exit programming mode by scanning the 'Enter/Exit Programming Mode' bar code again (scan 'Enter/Exit Programming Mode' twice if less than 20 characters have been selected).

**DEFAULT SETTING PREFIX: 00 (None)**  
**DEFAULT SETTING SUFFIX: 0D (CR)**



Set Prefix

Set Suffix







## AIM ID

AIM (Automatic Identification Manufacturers) label identifiers are assigned from a globally standardized list — as opposed to custom label ID characters you select yourself — and can be included with scanned bar code data. AIM label identifiers consist of three characters as follows:



- A close brace character (ASCII '['), followed by...
- A code character (see the table below), followed by...
- A modifier character (the modifier character is symbol dependent)

SYMBOLGY	CHAR	SYMBOLGY	CHAR	SYMBOLGY	CHAR
UPC/EAN	E	Code 128/EAN 128	C	Databar	e
Code 39	A	MSI/Plessey	M	Code 11	H
Codabar	F	RSS(GS1 Omnidirectional, GS1 Expanded)	e	PDF417, MicroPDF	L
Interleaved 2 of 5	I	Standard 2 of 5	S	DataMatrix	d
Code 93	G	ISBN	x <sup>a</sup>	QR Code, Micro QR Code	Q
Maxicode	U	Aztec	z		

a. ISBN (X with a 0 modifier character)

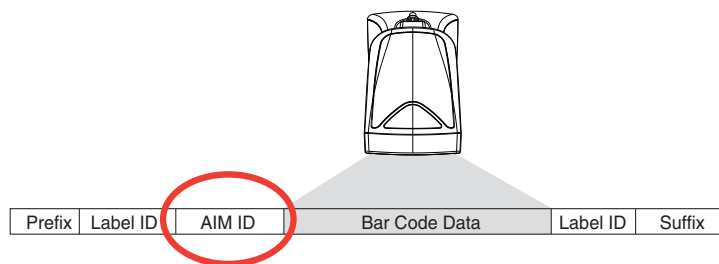
Figure 2. AIM ID



	<p><b>Disable AIM ID DEFAULT</b></p>
<p>Enable AIM ID</p>	









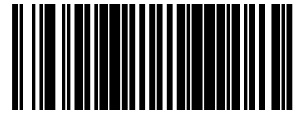

## Label ID

See the <cross-ref>“Label ID” section on page –135 for more information on setting this feature.

	Label ID Transmission: Disable
Label ID Position: Before bar code Data DEFAULT	
	Label ID Position: After bar code Data
Set UPC-A Label ID Character(s)	 DEFAULT SETTING FOR THIS FEATURE: A (41 hex)
 DEFAULT SETTING FOR THIS FEATURE: A (41 hex)	Set UPC-A w/P2 Addon Label ID Character(s)
Set UPC-A w/P5 Addon Label ID Character(s)	 DEFAULT SETTING FOR THIS FEATURE: A (41 hex)
 DEFAULT SETTING FOR THIS FEATURE: A (41 hex)	Set UPC-A w/C128 Addon Label ID Character(s)
Set UPC-E Label ID Character(s)	 DEFAULT SETTING FOR THIS FEATURE: E (45 hex)









**Label ID — cont.**

 <b>DEFAULT SETTING FOR THIS FEATURE: E (45 hex)</b>	Set UPC-E w/P2 Addon Label ID Character(s)
Set UPC-E w/P5 Addon Label ID Character(s)	 <b>DEFAULT SETTING FOR THIS FEATURE: E (45 hex)</b>
 <b>DEFAULT SETTING FOR THIS FEATURE: E (45 hex)</b>	Set UPC-E w/C128 Addon Label ID Character(s)
Set EAN-8 Label ID Character(s)	 <b>DEFAULT SETTING FOR THIS FEATURE: FF (4646 hex)</b>
 <b>DEFAULT SETTING FOR THIS FEATURE: FF (4646 hex)</b>	Set EAN-8 w/P2 Addon Label ID Character(s)
Set EAN-8 w/P5 Addon Label ID Character(s)	 <b>DEFAULT SETTING FOR THIS FEATURE: FF (4646 hex)</b>
 <b>DEFAULT SETTING FOR THIS FEATURE: FF (4646 hex)</b>	Set EAN-8 w/C128 Addon Label ID Character(s)
Set EAN-13 Label ID Character(s)	 <b>DEFAULT SETTING FOR THIS FEATURE: F (46 hex)</b>







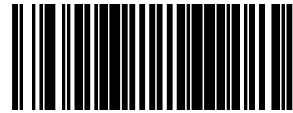



**Label ID — cont.**

 <p><b>DEFAULT SETTING FOR THIS FEATURE: F (46 hex)</b></p>	<p>Set EAN-13 w/P2 Addon Label ID Character(s)</p>
<p>Set EAN-13 w/P5 Addon Label ID Character(s)</p>	 <p><b>DEFAULT SETTING FOR THIS FEATURE: F (46 hex)</b></p>
 <p><b>DEFAULT SETTING FOR THIS FEATURE: F (46 hex)</b></p>	<p>Set EAN-13 w/C128 Addon Label ID Character(s)</p>
<p>Set ISBN Label ID Character(s)</p>	 <p><b>DEFAULT SETTING FOR THIS FEATURE: I (49 hex)</b></p>
 <p><b>DEFAULT SETTING FOR THIS FEATURE: G (47 hex)</b></p>	<p>Set GTIN Label ID Character(s)</p>
<p>Set GTIN w/P2 addon Label ID Character(s)</p>	 <p><b>DEFAULT SETTING FOR THIS FEATURE: G2 (4732 hex)</b></p>
 <p><b>DEFAULT SETTING FOR THIS FEATURE: G5 (4735 hex)</b></p>	<p>Set GTIN w/P5 addon Label ID Character(s)</p>







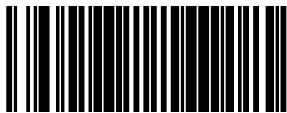

## Label ID — cont.

 <b>DEFAULT SETTING FOR THIS FEATURE: G8 (4738 hex)</b>	Set GTIN w/C128 addon Label ID Character(s)
Set GS1 Omnidirectional Label ID Character(s)	 <b>DEFAULT SETTING FOR THIS FEATURE: R4 (5234 hex)</b>
 <b>DEFAULT SETTING FOR THIS FEATURE: RX (5258 hex)</b>	Set GS1 Expanded Label ID Character(s)
Set Code GS1 DataBar Limited Label ID Character(s)	 <b>DEFAULT SETTING FOR THIS FEATURE: RL (524C0000 hex)</b>
 <b>DEFAULT SETTING FOR THIS FEATURE: * (2A hex)</b>	Set Code 39 Label ID Character(s)
Set Pharmacode 39 Label ID Character(s)	 <b>DEFAULT SETTING FOR THIS FEATURE: A (41 hex)</b>
 <b>DEFAULT SETTING FOR THIS FEATURE: # (23 hex)</b>	Set Code 128 Label ID Character(s)
Set I 2 of 5 Label ID Character(s)	 <b>DEFAULT SETTING FOR THIS FEATURE: i (69 hex)</b>



Label ID — cont.

 <p>DEFAULT SETTING FOR THIS FEATURE: % (25 hex)</p>	<p>Set Codabar Label ID Character(s)</p>
<p>Set Code 93 Label ID Character(s)</p>	 <p>DEFAULT SETTING FOR THIS FEATURE: &amp; (26 hex)</p>
 <p>DEFAULT SETTING FOR THIS FEATURE: CE (4345 hex)</p>	<p>Set Code 11 Label ID Character(s)</p>
<p>Set MSI/Plessey Label ID Character(s)</p>	 <p>DEFAULT SETTING FOR THIS FEATURE: @ (40 hex)</p>
 <p>DEFAULT SETTING FOR THIS FEATURE: s (73 hex)</p>	<p>Set Std 2 of 5 Label ID Character(s)</p>
<p>Set PDF 417 Label ID Character(s)</p>	 <p>DEFAULT SETTING FOR THIS FEATURE: P (5000 hex)<sup>a</sup></p>
 <p>DEFAULT SETTING FOR THIS FEATURE: Dm (446D hex)</p>	<p>Set Datamatrix Label ID Character(s)</p>

a. Default setting exceptions for PDF 417 Label ID are as follows: Default for RS-232 WN is 'Q' (0x5100). Default for USB-HID-POS is 'P' (0x5020), or 'P-Space'.

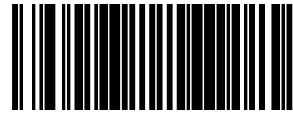







### Label ID — cont.



**NOTE**

For the 2D symbologies on this page, the Label ID is 4 bytes. The first 3 bytes are characters for the label ID. A 00 (hex) value in the first 3 bytes indicates the end of the label ID characters. The 4th byte is a control byte. The use of the control byte is as follows: bit 0—if set to 1, the AIM Id is appended for that label type

 <p>DEFAULT SETTING FOR THIS FEATURE: mP (6D500000 hex)</p>	<p>Set Micro PDF 417 Label ID Character(s)</p>
<p>Set QR Code Label ID Character(s)</p>	 <p>DEFAULT SETTING FOR THIS FEATURE: QR (51520000 hex)</p>
 <p>DEFAULT SETTING FOR THIS FEATURE: \$Q (2451 hex)</p>	<p>Set Micro QR Code Label ID Character(s)</p>
<p>Set Maxicode Label ID Character(s)</p>	 <p>DEFAULT SETTING FOR THIS FEATURE: MC (4D430000 hex)</p>
 <p>DEFAULT SETTING FOR THIS FEATURE: Az (417A0000 hex)</p>	<p>Set Aztec Label ID Character(s)</p>
<p>Set GS1 DataBar Omnidirectional 2D Composite Label ID Character(s)</p>	 <p>DEFAULT SETTING FOR THIS FEATURE: R4 (52340000 hex)</p>



**Label ID — cont.**



Set GS1 DataBar Limited 2D Composite Label ID Character(s)

DEFAULT SETTING FOR THIS FEATURE: RL (524C0000 hex)



Set GS1 DataBar Expanded 2D Composite Label ID Character(s)

DEFAULT SETTING FOR THIS FEATURE: RX (52340000 hex)

## Case Conversion

This feature can convert scanned bar code data to either all lower case (a through z) or all upper case (A through Z) characters.



**NOTE**

**Case conversion affects ONLY scanned bar code data, and does not affect Label ID, Prefix, Suffix, or other appended data.**



Disable DEFAULT

Convert to Upper Case



Convert to Lower Case





## Character Conversion

Character conversion is an eight byte configuration item. The eight bytes are 4 character pairs represented in hexadecimal ASCII values. The first character in the pair is the character that will be converted. The second character in the pair is the character to convert to. If the character to convert in a pair is **FF**, then no conversion is done.

For example, if you have the character conversion configuration item set to the following: **41423132FFFFFFFF**

The first pair is **4142** or **AB** (**41** hex is an ASCII capital A, **42** hex is an ASCII capital B) and the second pair is **3132** or **12** (**31** hex is an ASCII 1, **32** is an ASCII 2). The other two pairs are **FFFF** and **FFFF**.

With the label, **AG15TA81**, it would look as follows after the character conversion: **BG25TB82**.

The A characters were converted to the B character and the 1 characters were converted to the numeral 2 character. Nothing is done with the last two character pairs, since they are all **FF**.

To set Character Conversion:

1. Scan the START/END bar code.
2. Scan the Character Conversion bar code.
3. Determine the desired string. Up to sixteen positions can be determined as in the above example. Next, turn to the [ASCII Character Set on page 159](#) on the inside back cover of this manual and find the equivalent hex digits needed to fulfill the string.



**The positions not used must be filled with the character 'F'.**

### NOTE

4. Turn to [Appendix C, Alphanumeric Pad](#) and scan the bar codes representing the hex characters determined in the previous step. When the last character is scanned, the scanner will sound a triple beep.
5. Scan the START/END bar code to exit Programming Mode.



Character Conversion

DEFAULT SETTING FOR THIS FEATURE:  
FFFFFFFFFFFFFFFF hex (no conversion)



# NOTES



## Chapter 5 Symbologies

The scanner supports the following symbologies (bar code types). Options for each symbology are included in this chapter.

UPC-A	Code 32 Italian Pharmacode
UPC-E	Code 128
EAN-13	Interleaved 2 of 5
EAN-8/JAN-8	Codabar
GS1 DataBar Omnidirectional	Code 93
GS1 DataBar Expanded / Expanded Stacked	MSI/Plessey
GS1 DataBar Limited	Standard 2 of 5
Code 39	Code 11

**Factory Defaults** — for the standard RS-232 interface are indicated in bold text throughout this section. Reference [Appendix D, Default Settings](#) for default exceptions for your interface.



## UPC-A

### Disable/Enable UPC-A

When disabled, the scanner will not read UPC-A bar codes.

	Disable UPC-A
Enable UPC-A DEFAULT	

### Check Digit Transmission

Enable this option to transmit the check digit along with UPC-A bar code data.

	Don't Send Check Digit
Send Check Digit DEFAULT	





## Expand UPC-A to EAN-13

Expands UPC-A data to the EAN-13 data format. Selecting this feature also changes the symbology ID to match those required for EAN-13.

	<b>Don't Expand to EAN-13</b> DEFAULT
Expand to EAN-13	

## Number System Digit (NSD) Transmission



This feature enables/disables transmission of UPC-A System Number.

	Disable Number System Digit Transmission
Enable Number System Digit Transmission DEFAULT	



### UPC-A Minimum Reads

This feature specifies the minimum number of consecutive times a UPC-A label must be decoded before it is accepted as a good read.

	Minimum = 1 Read DEFAULT
Minimum = 2 Reads	
	Minimum = 3 Reads
Minimum = 4 Reads	

### UPC-A In-store Minimum Reads

This feature specifies the minimum number of consecutive times an in-store printed label must be decoded before it is accepted as good read.

	Minimum = 1 Read
Minimum = 2 Reads DEFAULT	
	Minimum = 3 Reads
Minimum = 4 Reads	



## UPC-E

The following options apply to the UPC-E symbology.

### Disable/Enable UPC-E

When disabled, the scanner will not read UPC-E bar codes.

	Disable UPC-E
Enable UPC-E DEFAULT	

### Check Digit Transmission

Enable this option to transmit the check digit along with UPC-E bar code data.

	Don't Send Check Digit
Send Check Digit DEFAULT	



### Number System Digit

The Number System Digit (NSD) which is always a zero (0) in the leading position can be optionally included (or not) with scanned bar code data.

	Exclude Number System Digit
Include Number System Digit DEFAULT	

### Expand to UPC-E to UPC-A

Enables/disables expansion of UPC-E labels to UPC-A. Selecting this feature also changes the symbology ID to match those required for UPC-A.

	Don't Expand UPC-E to UPC-A DEFAULT
Expand UPC-E to UPC-A	

### Expand UPC-E to EAN13

Enables/disables expansion of UPC-E labels to EAN-13. Selecting this feature also changes the symbology ID to match those required for EAN-13.





	Don't Expand UPC-E to EAN-13 DEFAULT
Expand UPC-E to EAN-13	





## Minimum Reads

This feature specifies the minimum number of consecutive times a UPC-E label must be decoded before it is accepted as good read.

	Minimum = 1 Read
Minimum = 2 Reads DEFAULT	
	Minimum = 3 Reads
Minimum = 4 Reads	

## GTIN

The following options apply to the GTIN label data format.

### Expand UPC/EAN to GTIN

Enables conversion of UPC-E, UPC-A, EAN8, and EAN13 labels into 14 character GTIN. If add-on information is present on the base label prior to the conversion taking place, the add-on information will be appended to the converted GTIN label.

	Don't Expand to GTIN DEFAULT
Expand to GTIN	



## EAN-13

The following options apply to the EAN-13 symbology.

### Disable/Enable EAN-13

Enables/disables ability of scanner to decode EAN/JAN13 labels.

	Disable EAN-13
Enable EAN-13 DEFAULT	

### Check Digit Transmission

Enable this option to transmit the check digit along with EAN-13 bar code data.

	Don't Send Check Digit
Send Check Digit DEFAULT	

### EAN-13 Flag 1 Character

Enables/disables transmission of an EAN/JAN13 Flag1 character.

	Don't Transmit EAN-13 Flag 1 Char
Transmit EAN-13 Flag 1 Char DEFAULT	



## ISBN

When enabled, this feature truncates the leading three digits from labels that contain ISBN (International Standard Book Number) and appends an ISBN check character to the end of the label. These codes are used for books and magazines. Labels with ISBN codes start with "978".

### Example:

bar code data: "9789572222720"

Output: "9572222724"

	Disable ISBN DEFAULT
Enable ISBN	

## Minimum Reads

This feature specifies the minimum number of consecutive times an EAN-13 label must be decoded before it is accepted as good read.

	Minimum = 1 Read DEFAULT
Minimum = 2 Reads	
	Minimum = 3 Reads
Minimum = 4 Reads	



## EAN-8/JAN-8

The following options apply to the EAN-8/JAN-8 symbology.

### Disable/Enable EAN-8/JAN-8

Enables/disables ability of scanner to decode EAN/JAN-8 labels.

	Disable EAN-8
Enable EAN-8 DEFAULT	

### Check Digit Transmission

Enable this option to transmit the check Digit along with EAN-8/JAN-8 bar code data.

	Don't Send Check Digit
Send Check Digit DEFAULT	





**Expand EAN-8 to EAN-13** — Expands EAN-8 data to the EAN-13 data format. Selecting this feature also changes the symbology ID to match those required for EAN-13.

	Don't Expand to EAN-13 DEFAULT
Expand to EAN-13	



## Minimum Reads

This feature specifies the minimum number of consecutive times an EAN-8 label must be decoded before it is accepted as good read.

	Minimum = 1 Read DEFAULT
Minimum = 2 Reads	
	Minimum = 3 Reads
Minimum = 4 Reads	





## EAN Two-Label

Enables/disables the ability of the scanner to decode EAN two-label pairs.

	Disable EAN Two-Label
Enable EAN Two-Label	

## EAN Two-Label Combined Transmission

Enables/disables the transmitting of an EAN two label pair as one label.

	EAN Two-Label Combined Transmission = Disable DEFAULT
EAN Two-Label Combined Transmission = Enable	



## Price Weight Check Digit

Enables/disables calculation and verification of price/weight check digits.



Applies to all UPC-A labels with a number system digit of 2 and EAN/JAN 13 labels with a Flag1 digit of 2

### NOTE

Here are the available options for this feature:

- Disable
- Enable 4-digit price/wt check-digit calculation
- Enable 5-digit price/wt check-digit calculation
- Enable European 4-digit price-weight check-digit calculation
- Enable European 5-digit price-weight check-digit calculation

	Price Weight Check Digit = Disable DEFAULT
Price Weight Check Digit = Enable 4-digit price/wt	
	Price Weight Check Digit = Enable 5-digit price/wt
Price Weight Check Digit = Enable European 4-digit price/wt	
	Price Weight Check Digit = Enable European 5-digit price/wt



## Add-ons

Add-ons (or supplemental characters) are commonly added to the end of UPC/EAN bar codes. The scanner will read the add-ons if they are enabled and in the field of view. Three add-on types are supported: 2-digit, 5-digit and Code 128 add-ons. Supported options are:

**None** — This option directs the scanner to ignore add-on portion of a UPC/EAN bar code but still read the main portion of the bar code.

**2 Digits** — The scanner will optionally read 2-digit add-ons with the UPC/EAN label.

**5 Digits** — The scanner will optionally read 5-digit add-ons with the UPC/EAN label.

**Code 128 Add-on** — The scanner will optionally read Code 128 add-ons with the UPC/EAN label.



Contact Customer Support for advanced programming of optional and conditional add-ons.



### NOTE

	Disable Optional 2-Digit Add-ons DEFAULT
Enable Optional 2-Digit Add-ons	
	Disable Optional 5-Digit Add-ons DEFAULT





**Add Ons- cont.**

Enable Optional 5-Digit Add-ons	
	Disable Optional Code 128 Add-ons DEFAULT
Enable Optional Code 128 Add-ons	



**NOTE**

If a UPC/EAN base label and a P2 add-on are both decoded, the scanner will transmit the base label and add-on. If a UPC/EAN base label is decoded without an add-on, the base label will be transmitted without an add-on.

Please note that conditional add-ons settings are considered by the scanner before optional add-on settings.

**2-Digit Addons Minimum Reads**

This setting configures the minimum number of times a 2-digit add-on must decode before it is marked valid.

Minimum = 2 Reads DEFAULT	
	Minimum = 3 Reads
Minimum = 4 Reads	



### 5-Digit Addons Minimum Reads

This setting configures the minimum number of times a 5-digit addon must decode before it is marked valid.

	Minimum = 1 Read DEFAULT
Minimum = 2 Reads	
	Minimum = 3 Reads
Minimum = 4 Reads	





## GS1 DataBar Omnidirectional

### (Stacked Omnidirectional)

The following options apply to the GS1 DataBar Omnidirectional symbology and are only functional if the value-added feature for GS1 is activated.



### Disable/Enable GS1 DataBar Omnidirectional

When this feature is disabled, the scanner will not read GS1 DataBar Omnidirectional bar codes.

	Disable GS1 DataBar Omnidirectional DEFAULT
Enable GS1 DataBar Omnidirectional	

### UCC/EAN 128 Emulation





When enabled, GS1 DataBar Omnidirectional bar codes will be translated to the UCC/EAN 128 label data format.

	Disable UCC/EAN 128 Emulation DEFAULT
Enable UCC/EAN 128 Emulation	



## Minimum Reads

This feature specifies the minimum number of consecutive times an GS1 DataBar Omnidirectional label must be decoded before it is accepted as good read.

	Minimum = 1 Read DEFAULT
Minimum = 2 Reads	
	Minimum = 3 Reads
Minimum = 4 Reads	





## GS1 DataBar Expanded / Expanded Stacked

The following options apply to the GS1 DataBar Expanded symbology and are only functional if the value-added feature for GS1 is activated.



### Disable/Enable GS1 DataBar Expanded

When this feature is disabled, the scanner will not read GS1 DataBar Expanded bar codes.

	Disable GS1 DataBar Expanded DEFAULT
Enable GS1 DataBar Expanded	

### GS1-128 Emulation

When enabled, GS1 DataBar Expanded bar codes will be translated to the GS1-128 label data format.

	Disable GS1-128 Emulation DEFAULT
Enable GS1-128 Emulation	



## Length Control

**Fixed Length Decoding** — When fixed length decoding is enabled, the scanner will decode a bar code if the label length matches one of the configurable fixed lengths.

**Variable Length Decoding** — When variable length decoding is enabled, the scanner will decode a bar code if the label length falls in the range of the configurable lengths 1 and 2.

	Variable Length Decoding DEFAULT
Fixed Length Decoding	

## GS1 DataBar Expanded Length 1, Length 2 Programming Instructions

See page 136 for detailed instructions on setting this feature.



**For GS1 DataBar Expanded bar codes, only the data characters are included in the length calculations.**





### NOTE

	Set Length 1
DEFAULT SETTING FOR THIS FEATURE: 01	
Set Length 2	
DEFAULT SETTING FOR THIS FEATURE: 74	



## Minimum Reads

This feature specifies the minimum number of consecutive times an GS1 DataBar Expanded label must be decoded before it is accepted as good read.

	Minimum = 1 Read DEFAULT
Minimum = 2 Reads	
	Minimum = 3 Reads
Minimum = 4 Reads	



## Coupon Read Control

This feature controls coupon reading.



### NOTE

**UPCA labels that start with a '5' are defined as coupon labels.**

**EAN13 labels that start with '99' are defined as coupon labels.**

**GS1 Expanded labels that start with '8110' are defined as coupon labels.**

Options are:

- **Disable** – Disable coupon filtering
- **Enable UPC-A Coupon Decoding** – UPCA/EAN13 labels including coupon labels will decode but GS1 Expanded coupon labels will not. GS1 Expanded labels that are not coupon labels will decode.
- **Enable GS1 Expanded Coupon Decoding** – GS1 Expanded labels including coupon labels will decode but UPC-A/EAN-13 coupon labels will not. UPC-A/EAN-13 labels that are not coupon labels will decode.

	Disable coupon filtering
Enable UPC-A Coupon Decoding Disable GS1 DataBar coupon decoding <b>DEFAULT</b>	
	Enable GS1 DataBar coupon decoding Disable UPC-A coupon decoding





## GS1 DataBar Limited

The following options apply to the GS1 DataBar Limited symbology.

### Disable/Enable GS1 DataBar Limited

When this feature is disabled, the scanner will not read GS1 DataBar Limited bar codes.

	Disable GS1 DataBar Limited DEFAULT
Enable GS1 DataBar Limited	

### GS1-128 Emulation

When enabled, GS1 DataBar Limited bar codes will be translated to the GS1-128 label data format.

	Disable GS1-128 Emulation DEFAULT
Enable GS1-128 Emulation	



## Minimum Reads

This feature specifies the minimum number of consecutive times an GS1 DataBar Limited label must be decoded before it is accepted as good read.

	Minimum = 1 Read DEFAULT
Minimum = 2 Reads	
	Minimum = 3 Reads
Minimum = 4 Reads	



## Code 39

The following options apply to the Code 39 symbology.



### Disable/Enable Code 39

When this feature is disabled, the scanner will not read Code 39 bar codes.

	Disable Code 39
Enable Code 39 DEFAULT	

### Check Character Calculation



When enabled, the scanner will calculate the check character of the labels. Turn this option on only when a checksum is present in the Code 39 labels. When disabled, any check character in the label is treated as a data character.

	Disable Check Char Calculation DEFAULT
Enable Check Char Calculation	





## Check Character Transmit

Enable this option to transmit the check character with scanned bar code data.

	Disable Check Char Transmission
Enable Check Char Transmission DEFAULT	

## Start/Stop Characters

Enables/disables transmission of Code 39 start and stop characters.

	Don't Transmit Start/Stop Characters DEFAULT
Transmit Start/Stop Characters	



## Code 39 Full ASCII

Enables/disables the translation of Code 39 characters to Code 39 full-ASCII characters.

	Disable Code 39 Full ASCII DEFAULT
Enable Code 39 Full ASCII	

## Length Control

**Fixed Length Decoding** — When fixed length decoding is enabled, the scanner will decode a bar code if the label length matches one of the configurable fixed lengths.

**Variable Length Decoding** — When variable length decoding is enabled, the scanner will decode a bar code if the label length falls in the range of the configurable lengths 1 and 2.

	Variable Length Decoding DEFAULT
Fixed Length Decoding	





## Code 39 Length 1, Length 2 Programming Instructions

See page 136 for detailed instructions on setting this feature.



**NOTE**

For Code 39 bar codes, all check, data and full ASCII shift characters are included in the length calculations. Start/Stop characters are not included.

	<p>Set Length 1</p> <p>DEFAULT SETTING FOR THIS FEATURE: 02</p>
<p>Set Length 2</p>	 <p>DEFAULT SETTING FOR THIS FEATURE: 50</p>

## Quiet Zones

This feature enables/disables the requirement that quiet zones must be present for Code 39 bar codes.

	<p>Don't require Quiet Zones</p> <p>DEFAULT</p>
<p>Require Quiet Zones</p>	



## Code 39 Stitching

Enables/disables stitching for Code 39 labels. When parts of a Code 39 bar code are presented to the scanner with this feature enabled, the bar code parts will be assembled by the scanner's software, and the data will be decoded if all bar code proofing requirements are met.

	Disable Code 39 Stitching
Enable Code 39 Stitching DEFAULT	

## Minimum Reads

This feature specifies the minimum number of consecutive times a Code 39 label must be decoded before it is accepted as good read.

	Minimum = 1 Read DEFAULT
Minimum = 2 Reads	
	Minimum = 3 Reads
Minimum = 4 Reads	



## Code 32 Italian Pharmacode

The following options apply to the Code 32 Italian Pharmacode symbology. The feature, [Disable/Enable Code 39](#) on page 5-83, must also be enabled for the scanner to read Pharmacode 39 labels.

### Disable/Enable Code 32 Italian Pharmacode

When this feature is disabled, the scanner will not read Code 32 Italian Pharmacode bar codes.

	Disable Code 32 Italian Pharmacode DEFAULT
Enable Code 32 Italian Pharmacode	

### Start/Stop Characters

Enables or disables transmission of Code 32 Italian Pharmacode start/stop characters.

	Don't Transmit Start/Stop Characters DEFAULT
Transmit Start/Stop Characters	





## Check Character Transmit

Enable this option to transmit the check character with scanned bar code data.

	Disable Check Char Transmission <b>DEFAULT</b>
Enable Check Char Transmission	

## Code 128

The following options apply to the Code 128 symbology.

### Disable/Enable Code 128

When this feature is disabled, the scanner will not read Code 128 bar codes.

	Disable Code 128
Enable Code 128 <b>DEFAULT</b>	



### Disable/Enable EAN 128

Enables/disables ability of scanner to translate EAN128 labels to the EAN128 data format.

	Transmit EAN128 labels in Code128 data format
Transmit EAN128 labels in EAN128 data format DEFAULT	

### Transmit Function Characters

Enables/disables transmission of Code128 function characters 1, 2, 3, and 4. Function codes are transmitted as follows:

- FNC1 = 80 hex
- FNC2 = 81 hex
- FNC3 = 82 hex
- FNC4 = 83 hex



**NOTE**

If the label starts with a function 3 character, it is considered a programming label and no modifications are made to the label data. Other than that, if this configuration item is set to disable, then all function characters are stripped from the label data.

Disabled is the recommended setting for all interfaces.

	Don't Transmit Function Characters DEFAULT
Transmit Function Characters	



## Length Control

**Fixed Length Decoding** — When fixed length decoding is enabled, the scanner will decode a bar code if the label length matches one of the configurable fixed lengths.

**Variable Length Decoding** — When variable length decoding is enabled, the scanner will decode a bar code if the label length falls in the range of the configurable lengths 1 and 2.

	Variable Length Decoding DEFAULT
Fixed Length Decoding	

## Code 128 Length 1, Length 2 Programming Instructions

See page 136 for detailed instructions on setting this feature



**NOTE**

For Code 128 bar codes, only the data characters are included in the length calculations.

	Set Length 1
DEFAULT SETTING FOR THIS FEATURE: 01	
Set Length 2	
DEFAULT SETTING FOR THIS FEATURE: 50	



### Code 128 Conversion to Code 39

Enables/disables expansion of Code 128 labels to Code 39. When enabled, the label identifier for a Code128 label shall be set to Code 39 and all Code 39 formatting control shall be applied to the label.

	Disable DEFAULT
Enable	

### Code 128 Stitching

Enables/disables stitching for Code 128 labels. When parts of a Code 128 bar code are presented to the scanner with this feature enabled, the bar code parts will be assembled by the scanner’s software, and the data will be decoded if all bar code proofing requirements are met.

	Disable Code 128 Stitching
Enable Code 128 Stitching DEFAULT	



## Minimum Reads

This feature specifies the minimum number of consecutive times a Code 128 label must be decoded before it is accepted as good read.

	Minimum = 1 Read DEFAULT
Minimum = 2 Reads	
	Minimum = 3 Reads
Minimum = 4 Reads	



## Interleaved 2 of 5

The following options apply to the Interleaved 2 of 5 (I 2 of 5) symbology.



### Disable/Enable Interleaved 2 of 5

When this feature is disabled, the scanner will not read Interleaved 2 of 5 bar codes.

	Disable Interleaved 2 of 5 DEFAULT
Enable Interleaved 2 of 5	

### Check Digit Calculation



When enabled, the scanner will calculate the check digit of the labels. When disabled, any check character in the label is treated as a data character

	Disable Check Digit Calculation DEFAULT
Enable Check Digit Calculation	



## Check Digit Transmit

Enable this option to transmit the check digit with scanned bar code data. Applies when the feature [Check Digit Calculation](#) on page 5-94 is enabled.

	Disable Check Digit Calculation
Enable Check Digit Calculation <b>DEFAULT</b>	

## Length Control

**Fixed Length Decoding** — When fixed length decoding is enabled, the scanner will decode a bar code if the label length matches one of the configurable fixed lengths.

**Variable Length Decoding** — When variable length decoding is enabled, the scanner will decode a bar code if the label length falls in the range of the configurable minimum and maximum length.

	Variable Length Decoding <b>DEFAULT</b>
Fixed Length Decoding	



## Interleaved 2 of 5 Length 1, Length 2 Programming Instructions

See page 136 for detailed instructions on setting this feature.



**NOTE**

For Interleaved 2 of 5 bar codes, lengths must be an even number. Additionally, all check and data characters are included in the length calculations.

	Set Length 1
DEFAULT SETTING FOR THIS FEATURE: 06	
Set Length 2	
DEFAULT SETTING FOR THIS FEATURE: 50	

## Interleaved 2 of 5 Stitching

Enables/disables stitching for Interleaved 2 of 5 labels. When parts of an Interleaved 2 of 5 bar code are presented to the scanner with this feature enabled, the bar code parts will be assembled by the scanner's software, and the data will be decoded if all bar code proofing requirements are met.



**NOTE**

Only functions when Fixed Length Decoding is enabled.

	Disable Interleaved 2 of 5 Stitching DEFAULT
Enable Interleaved 2 of 5 Stitching	





## Minimum Reads

This feature specifies the minimum number of consecutive times an Interleaved 2 of 5 label must be decoded before it is accepted as good read.

	Minimum = 1 Read DEFAULT
Minimum = 2 Reads	
	Minimum = 3 Reads
Minimum = 4 Reads	

## Codabar

The following options apply to the Codabar symbology.

### Disable/Enable Codabar

When this feature is disabled, the scanner will not read Codabar bar codes.

	Disable Codabar DEFAULT
Enable Codabar	



## Check Character Verification

When enabled, the scanner will verify the check character of the labels. When disabled, any check characters in a label are treated as data characters

	Disable Check Char Verification <b>DEFAULT</b>
Enable Check Char Verification	

## Check Character Transmit

Enable this option to transmit the check character with scanned bar code data. Applies when the feature [Check Character Verification](#) on page 5-98 is enabled.

	Disable Check Char Transmission
Enable Check Char Transmission <b>DEFAULT</b>	



## Length Control

**Fixed Length Decoding** — When fixed length decoding is enabled, the scanner will decode a bar code if the label length matches one of the configurable fixed lengths.

**Variable Length Decoding** — When variable length decoding is enabled, the scanner will decode a bar code if the label length falls in the range of the configurable minimum and maximum length.

	Variable Length Decoding DEFAULT
Fixed Length Decoding	

## Codabar Length 1, Length 2 Programming Instructions

See page 136 for detailed instructions on setting this feature.



### NOTE

For Codabar bar codes, all start, stop, check and data characters are included in the length calculations.

DEFAULT SETTING FOR THIS FEATURE: 03	
	Set Length 1
Set Length 2	DEFAULT SETTING FOR THIS FEATURE: 50



## Quiet Zones

This feature enable/disables the requirement that quiet zones must be present for Codabar bar codes.

	Don't require Quiet Zones DEFAULT
Require Quiet Zones	

## Start/Stop Character Type



Codabar has four pairs of Start/Stop patterns. Select one pair to match your application.

	Start/Stop Type: ABCD/TN*E
Start/Stop Type: ABCD/ABCD	
	Start/Stop Type: abcd/tn*e
Start/Stop Type: abcd/abcd DEFAULT	





## Start/Stop Character Transmission

The transmission of start and end characters of Codabar is selected below.

	Disable Start/Stop Char Transmission
Enable Start/Stop Char Transmission DEFAULT	

## Start/Stop Character Match

This feature enables/disables the requirement that start and stop characters match.

	Disable Start/Stop Char Match DEFAULT
Enable Start/Stop Char Match	



## Codabar Stitching

Enables/disables stitching for Codabar labels. When parts of a Codabar label are presented to the scanner with this feature enabled, the bar code parts will be assembled by the scanner's software, and the data will be decoded if all bar code proofing requirements are met.



**NOTE**

Only functions when Fixed Length Decoding is enabled.

	Disable Codabar Stitching DEFAULT
Enable Codabar Stitching	



## Minimum Reads

This feature specifies the minimum number of consecutive times a Codabar label must be decoded before it is accepted as a good read.

	Minimum = 1 Read DEFAULT
Minimum = 2 Reads	
	Minimum = 3 Reads
Minimum = 4 Reads	



## Code 93

The following options apply to the Code 93 symbology.

### Disable/Enable Code 93



When this feature is disabled, the scanner will not read Code 93 bar codes.

	Disable Code 93 DEFAULT
Enable Code 93	

### Length Control

**Fixed Length Decoding** — When fixed length decoding is enabled, the scanner will decode a bar code if the label length matches one of the configurable fixed lengths.

**Variable Length Decoding** — When variable length decoding is enabled, the scanner will decode a bar code if the label length falls in the range of the configurable minimum and maximum length.

	Variable Length Decoding DEFAULT
Fixed Length Decoding	





## Code 93 Length 1, Length 2 Programming Instructions

See page 136 for detailed instructions on setting this feature.



### NOTE

For Code 93 bar codes, only the data characters are included in the length calculations.

	Set Length 1
DEFAULT SETTING FOR THIS FEATURE: 01	
Set Length 2	
DEFAULT SETTING FOR THIS FEATURE: 50	

## Code 93 Stitching

Enables/disables stitching for Code 93 bar codes. When parts of a Code 93 label are presented to the scanner with this feature enabled, the bar code parts will be assembled by the scanner's software, and the data will be decoded if all bar code proofing requirements are met.





	Disable Code 93 Stitching
Enable Code 93 Stitching DEFAULT	





## Minimum Reads

This feature specifies the minimum number of consecutive times a Code 93 label must be decoded before it is accepted as a good read.

	Minimum = 1 Read DEFAULT
Minimum = 2 Reads	
	Minimum = 3 Reads
Minimum = 4 Reads	

## MSI/Plessey

The following options apply to the MSI/Plessey symbology.

### Disable/Enable MSI/Plessey

When this feature is disabled, the scanner will not read MSI/Plessey bar codes.

	Disable MSI/Plessey DEFAULT
Enable MSI/Plessey	



### Check Digit Verification

This feature specifies whether one or two check digits are to be calculated and verified. When disabled, any check characters in a label are treated as data characters.

	Disable Check Digit Verification
Enable Check Digit Verification DEFAULT	

### Check Digit Transmit

When this option is enabled, the scanner will transmit one-digit or two-digit check digits, depending upon the setting for check digit verification. Applies when the feature [Check Digit Verification](#) on page 5-106 is enabled.

	Disable Check Digit Transmission
Enable Check Digit Transmission DEFAULT	

### Number of Check Characters

Specifies number of MSI/Plessey check characters to be calculated and verified. Check characters are always modulus 10.

	1 Check Character DEFAULT
2 Check Characters	



## Length Control

**Fixed Length Decoding** — When fixed length decoding is enabled, the scanner will decode a bar code if the label length matches one of the configurable fixed lengths.

**Variable Length Decoding** — When variable length decoding is enabled, the scanner will decode a bar code if the label length falls in the range of the configurable minimum and maximum length.

	<p>Variable Length Decoding DEFAULT</p>
<p>Fixed Length Decoding</p>	



## MSI/Plessey Length 1, Length 2 Programming Instructions

See page 136 for detailed instructions on setting this feature.



### NOTE

For MSI/Plessey bar codes, all check and data characters are included in the length calculations.

 <p>DEFAULT SETTING FOR THIS FEATURE: 04</p>	<p>Set Length 1</p>
<p>Set Length 2</p>	 <p>DEFAULT SETTING FOR THIS FEATURE: 16</p>



## MSI/Plessey Stitching

Enables/disables stitching for MSI/Plessey bar codes. When parts of an MSI/Plessey label are presented to the scanner with this feature enabled, the bar code parts will be assembled by the scanner’s software, and the data will be decoded if all bar code proofing requirements are met.



**NOTE**

Only functions when Fixed Length Decoding is enabled.

	Disable MSI/Plessey Stitching DEFAULT
Enable MSI/Plessey Stitching	

## Minimum Reads

This feature specifies the minimum number of consecutive times an MSI/Plessey label must be decoded before it is accepted as good read.

	Minimum = 1 Read DEFAULT
Minimum = 2 Reads	
	Minimum = 3 Reads
Minimum = 4 Reads	



## Standard 2 of 5

The following options apply to the Standard 2 of 5 symbology.



### Disable/Enable Standard 2 of 5

When this feature is disabled, the scanner will not read Standard 2 of 5 bar codes.

	Disable Std 2 of 5 DEFAULT
Enable Std 2 of 5	



### Check Digit Verification

When enabled, the scanner will verify the check digit of the labels.

	Disable Check Digit Verification DEFAULT
Enable Check Digit Verification	

### Check Digit Transmit

When this option is enabled, the scanner will transmit the check digit. Applies when the feature [Check Digit Verification](#) on page 5-109 is enabled

	Disable Check Digit Transmission
Enable Check Digit Transmission DEFAULT	



## Length Control

**Fixed Length Decoding** — When fixed length decoding is enabled, the scanner will decode a bar code if the label length matches one of the configurable fixed lengths.

**Variable Length Decoding** — When variable length decoding is enabled, the scanner will decode a bar code if the label length falls in the range of the configurable minimum and maximum length.

	Variable Length Decoding DEFAULT
Fixed Length Decoding	

## Standard 2 of 5 Length 1, Length 2 Programming Instructions

See page 136 for detailed instructions on setting this feature.



**NOTE**

For Standard 2 of 5 BAR CODES, all check and data characters are included in the length calculations.

	Set Length 1
DEFAULT SETTING FOR THIS FEATURE: 08	
Set Length 2	
DEFAULT SETTING FOR THIS FEATURE: 50	



## Standard 2 of 5 Stitching

Enables/disables stitching for Standard 2 of 5 bar codes. When parts of a Standard 2 of 5 label are presented to the scanner with this feature enabled, the bar code parts will be assembled by the scanner's software, and the data will be decoded if all bar code proofing requirements are met.



Only functions when Fixed Length Decoding is enabled.

### NOTE

	Disable Std 2 of 5 Stitching DEFAULT
Enable Std 2 of 5 Stitching	

## Minimum Reads

This feature specifies the minimum number of consecutive times a Standard 2 of 5 label must be decoded before it is accepted as good read.

	Minimum = 1 Read DEFAULT
Minimum = 2 Reads	
	Minimum = 3 Reads
Minimum = 4 Reads	



## Code 11

The following options apply to the Code 11 symbology.

### Disable/Enable Code 11

Enables/disables ability of scanner to decode Code 11 labels.

	Disable Code 11 DEFAULT
Enable EAN-8	

### Check Character Transmission

Enables/disables transmission of Code 11 check characters.

	Don't Send Check Digit DEFAULT
Send Check Digit	

**Number of Check Characters** — Specifies the number of Code 11 check characters to be calculated and verified.

	Number of Check Characters = One Check Character DEFAULT
Number of Check Characters = Two Check Characters	





## Length Control

**Fixed Length Decoding** — When fixed length decoding is enabled, the scanner will decode a bar code if the label length matches one of the configurable fixed lengths.

**Variable Length Decoding** — When variable length decoding is enabled, the scanner will decode a bar code if the label length falls in the range of the configurable minimum and maximum length.

	Variable Length Decoding DEFAULT
Fixed Length Decoding	

## Code 11 Length 1, Length 2 Programming Instructions

See page 136 for detailed instructions on setting this feature.



**NOTE**

For Code 39 bar codes, all check, data and full ASCII shift characters are included in the length calculations. Start/Stop characters are not included.

	Set Length 1
DEFAULT SETTING FOR THIS FEATURE: 04	
Set Length 2	
	DEFAULT SETTING FOR THIS FEATURE: 32



## Minimum Reads

This feature specifies the minimum number of consecutive times a Code 11 label must be decoded before it is accepted as good read.

	Minimum = 1 Read DEFAULT
Minimum = 2 Reads	
	Minimum = 3 Reads
Minimum = 4 Reads	



# Chapter 6

## 2D Symbologies



The features in this section are available **ONLY** for models with 2D features activated.

**NOTE**

### 2D Symbologies

The scanner supports the 2D symbologies (bar code types) listed below. Available options for each 2D symbology are included in this chapter.

PDF 417  
Micro PDF 417  
Datamatrix  
QR Code

QR Code  
Maxicode  
Aztec  
Composite Labels



## PDF 417

### Disable/Enable PDF 417

When disabled, the scanner will not read PDF 417 bar codes.

	Disable PDF 417
Enable PDF 417 DEFAULT	

### Length Control

**Fixed Length Decoding** — When fixed length decoding is enabled, the scanner will decode a bar code if the label length matches one of the configurable fixed lengths.

**Variable Length Decoding** — When variable length decoding is enabled, the scanner will decode a bar code if the label length falls in the range of the configurable minimum and maximum length.

Configuring Fixed Length Decoding:

1. Scan the START bar code.
2. Scan the Fixed Length Decoding bar code.
3. Scan the END bar code.
4. Set Length 1 to the first fixed length by following the Length 1, Length 2 Programming Instructions below.
5. Set Length 2 to the second fixed length (or to '0000' if there is only one fixed length) by following the [PDF 417 Length 1, Length 2 Programming Instructions](#) below.

Configuring Variable Length Decoding:

1. Scan the START bar code.
2. Scan the Variable Length Decoding bar code.
3. Scan the END bar code.
4. Set Length 1 to the minimum length by following the [PDF 417 Length 1, Length 2 Programming Instructions](#) below.
5. Set Length 2 to the maximum length by following the [PDF 417 Length 1, Length 2 Programming Instructions](#) below.

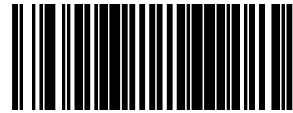

Enter/Exit Programming Mode

	Variable Length Decoding DEFAULT
Fixed Length Decoding	

### PDF 417 Length 1, Length 2 Programming Instructions

1. Scan the START bar code.
2. Scan either the Set Length 1 or Set Length 2 bar code.
3. Turn to [Alphanumeric Pad](#) and scan the four digits (zero-padded) representing the length.



**NOTE**

For PDF 417 bar codes, only the data characters are included in the length calculations.

Any value set higher than 2710 will be considered to be 2710.

Scan the END bar code.

	Set Length 1
DEFAULT SETTING FOR THIS FEATURE: 0001	
Set Length 2	
DEFAULT SETTING FOR THIS FEATURE: 2710	



## Micro PDF 417

### Disable/Enable Micro PDF 417

When disabled, the scanner will not read Micro PDF 417 bar codes.

	Disable Micro PDF 417 DEFAULT
Enable Micro PDF 417	

### Length Control

**Fixed Length Decoding** — When fixed length decoding is enabled, the scanner will decode a bar code if the label length matches one of the configurable fixed lengths.

**Variable Length Decoding** — When variable length decoding is enabled, the scanner will decode a bar code if the label length falls in the range of the configurable minimum and maximum length.

Configuring Fixed Length Decoding:

1. Scan the START bar code.
2. Scan the Fixed Length Decoding bar code.
3. Scan the END bar code.
4. Set Length 1 to the first fixed length by following the Length 1, Length 2 Programming Instructions below.
5. Set Length 2 to the second fixed length (or to '0000' if there is only one fixed length) by following the [Micro PDF 417 Length 1, Length 2 Programming Instructions](#) below.

Configuring Variable Length Decoding:

1. Scan the START bar code.
2. Scan the Variable Length Decoding bar code.
3. Scan the END bar code.
4. Set Length 1 to the minimum length by following the [Micro PDF 417 Length 1, Length 2 Programming Instructions](#) below.

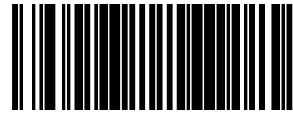

- Set Length 2 to the maximum length by following the [Micro PDF 417 Length 1, Length 2 Programming Instructions](#) below.

	Variable Length Decoding DEFAULT
Fixed Length Decoding	

### Micro PDF 417 Length 1, Length 2 Programming Instructions

- Scan the START bar code.
- Scan either the Set Length 1 or Set Length 2 bar code.
- Turn to [Alphanumeric Pad](#) and scan the three digits (zero-padded) representing the length.



**For Micro PDF 417 bar codes, only the data characters are included in the length calculations.**

**Any value set higher than 366 will be considered to be 366.**

**NOTE**

Scan the END bar code.

	Set Length 1
<b>DEFAULT SETTING FOR THIS FEATURE: 001</b>	
Set Length 2	
<b>DEFAULT SETTING FOR THIS FEATURE: 366</b>	



## Datamatrix

### Disable/Enable Datamatrix

When disabled, the scanner will not read Datamatrix bar codes.

	Disable Datamatrix DEFAULT
Enable Datamatrix	

## Dot Matrix Datamatrix Labels

When enabled, the scanner will read Datamatrix labels ink printed with ROUND, dot matrix modules.



This feature does NOT support dot-peened, laser or chemical etched labels.

### NOTE

	Disable Dot Matrix DEFAULT
Enable Dot Matrix	

## Length Control

**Fixed Length Decoding** — When fixed length decoding is enabled, the scanner will decode a bar code if the label length matches one of the configurable fixed lengths.

**Variable Length Decoding** — When variable length decoding is enabled, the scanner will decode a bar code if the label length falls in the range of the configurable minimum and maximum length.





Configuring Fixed Length Decoding:

1. Scan the START bar code.
2. Scan the Fixed Length Decoding bar code.
3. Scan the END bar code.
4. Set Length 1 to the first fixed length by following the Length 1, Length 2 Programming Instructions below.
5. Set Length 2 to the second fixed length (or to '0000' if there is only one fixed length) by following the [Datamatrix Length 1, Length 2 Programming Instructions](#) below.

Configuring Variable Length Decoding:

1. Scan the START bar code.
2. Scan the Variable Length Decoding bar code.
3. Scan the END bar code.
4. Set Length 1 to the minimum length by following the [Datamatrix Length 1, Length 2 Programming Instructions](#) below.
5. Set Length 2 to the maximum length by following the [Datamatrix Length 1, Length 2 Programming Instructions](#) below.

	Variable Length Decoding DEFAULT
Fixed Length Decoding	



### Datamatrix Length 1, Length 2 Programming Instructions

1. Scan the START bar code.
2. Scan either the Set Length 1 or Set Length 2 bar code.
3. Turn to [Alphanumeric Pad](#) and scan the three digits (zero-padded) representing the length.





**NOTE**

For Datamatrix bar codes, only the data characters are included in the length calculations.

Any value set higher than 800 will be considered to be 800.



Scan the END bar code.

	Set Length 1
DEFAULT SETTING FOR THIS FEATURE: 001	
Set Length 2	
DEFAULT SETTING FOR THIS FEATURE: 800	

## QR Code

### Disable/Enable QR Code

When disabled, the scanner will not read QR Code labels.

	Disable QR Code DEFAULT
Enable QR Code	

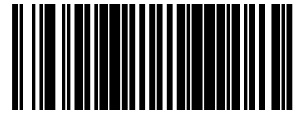

## Length Control

**Fixed Length Decoding** — When fixed length decoding is enabled, the scanner will decode a bar code if the label length matches one of the configurable fixed lengths.

**Variable Length Decoding** — When variable length decoding is enabled, the scanner will decode a bar code if the label length falls in the range of the configurable minimum and maximum length.

Configuring Fixed Length Decoding:

1. Scan the START bar code.
2. Scan the Fixed Length Decoding bar code.
3. Scan the END bar code.
4. Set Length 1 to the first fixed length by following the Length 1, Length 2 Programming Instructions below.
5. Set Length 2 to the second fixed length (or to '0000' if there is only one fixed length) by following the [QR Code Length 1, Length 2 Programming Instructions](#) below.

Configuring Variable Length Decoding:

1. Scan the START bar code.
2. Scan the Variable Length Decoding bar code.
3. Scan the END bar code.
4. Set Length 1 to the minimum length by following the [QR Code Length 1, Length 2 Programming Instructions](#) below.
5. Set Length 2 to the maximum length by following the [QR Code Length 1, Length 2 Programming Instructions](#) below.

	Variable Length Decoding DEFAULT
Fixed Length Decoding	



### QR Code Length 1, Length 2 Programming Instructions

1. Scan the START bar code.
2. Scan either the Set Length 1 or Set Length 2 bar code.
3. Turn to [Alphanumeric Pad](#) and scan the four digits (zero-padded) representing the length.



**NOTE**

For QR Code labels, only the data characters are included in the length calculations.

Any value set higher than 2710 will be considered to be 2710.

Scan the END bar code.

	Set Length 1
DEFAULT SETTING FOR THIS FEATURE: 0001	
Set Length 2	
DEFAULT SETTING FOR THIS FEATURE: 2710	

### Micro QR Code

#### Disable/Enable Micro QR Code

When disabled, the scanner will not read Micro QR Code labels.

	Disable Micro QR Code DEFAULT
Enable Micro QR Code	



**NOTE**

Micro QR Code follows all of the QR Code configuration settings for Length Control.

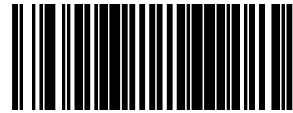

## Maxicode

### Disable/Enable Maxicode

When disabled, the scanner will not read Maxicode labels.

	Disable Maxicode DEFAULT
Enable Maxicode	

### Length Control

**Fixed Length Decoding** — When fixed length decoding is enabled, the scanner will decode a bar code if the label length matches one of the configurable fixed lengths.

**Variable Length Decoding** — When variable length decoding is enabled, the scanner will decode a bar code if the label length falls in the range of the configurable minimum and maximum length.

Configuring Fixed Length Decoding:

1. Scan the START bar code.
2. Scan the Fixed Length Decoding bar code.
3. Scan the END bar code.
4. Set Length 1 to the first fixed length by following the Length 1, Length 2 Programming Instructions below.
5. Set Length 2 to the second fixed length (or to '0000' if there is only one fixed length) by following the [Maxicode Length 1, Length 2 Programming Instructions](#) below.

Configuring Variable Length Decoding:

1. Scan the START bar code.
2. Scan the Variable Length Decoding bar code.
3. Scan the END bar code.
4. Set Length 1 to the minimum length by following the [Maxicode Length 1, Length 2 Programming Instructions](#) below.
5. Set Length 2 to the maximum length by following the [Maxicode Length 1, Length 2 Programming Instructions](#) below.



	Variable Length Decoding DEFAULT
Fixed Length Decoding	

### Maxicode Length 1, Length 2 Programming Instructions

1. Scan the START bar code.
2. Scan either the Set Length 1 or Set Length 2 bar code.
3. Turn to [Alphanumeric Pad](#) and scan the three digits (zero-padded) representing the length.



**For Maxicode labels, only the data characters are included in the length calculations.**

**Any value set higher than 138 will be considered to be 138.**

**NOTE**

Scan the END bar code.

	Set Length 1  DEFAULT SETTING FOR THIS FEATURE: 001
Set Length 2	 DEFAULT SETTING FOR THIS FEATURE: 138



## Aztec

### Disable/Enable Aztec

When disabled, the scanner will not read Aztec labels.

	Disable Aztec DEFAULT
Enable Aztec	

### Length Control

**Fixed Length Decoding** — When fixed length decoding is enabled, the scanner will decode a bar code if the label length matches one of the configurable fixed lengths.

**Variable Length Decoding** — When variable length decoding is enabled, the scanner will decode a bar code if the label length falls in the range of the configurable minimum and maximum length.

Configuring Fixed Length Decoding:

1. Scan the START bar code.
2. Scan the Fixed Length Decoding bar code.
3. Scan the END bar code.
4. Set Length 1 to the first fixed length by following the Length 1, Length 2 Programming Instructions below.
5. Set Length 2 to the second fixed length (or to '0000' if there is only one fixed length) by following the [Aztec Length 1, Length 2 Programming Instructions](#) below.

Configuring Variable Length Decoding:

1. Scan the START bar code.
2. Scan the Variable Length Decoding bar code.
3. Scan the END bar code.
4. Set Length 1 to the minimum length by following the [Aztec Length 1, Length 2 Programming Instructions](#) below.
5. Set Length 2 to the maximum length by following the [Aztec Length 1, Length 2 Programming Instructions](#) below.



	Variable Length Decoding DEFAULT
Fixed Length Decoding	

### Aztec Length 1, Length 2 Programming Instructions

1. Scan the START bar code.
2. Scan either the Set Length 1 or Set Length 2 bar code.
3. Turn to [Alphanumeric Pad](#) and scan the four digits (zero-padded) representing the length.



**NOTE**

For Aztec labels, only the data characters are included in the length calculations.

Any value set higher than 3700 will be considered to be 2710.

Scan the END bar code.

DEFAULT SETTING FOR THIS FEATURE: 0001	
	Set Length 1
Set Length 2	
DEFAULT SETTING FOR THIS FEATURE: 2710	







## Composite Labels

### Disable/Enable GS1 DataBar Omnidirectional 2D Component

When enabled, if a GS1 DataBar Omnidirectional label is decoded which has the 2D linkage flag set, the 2D component must also be decoded or the base label will be discarded.



When disabled, only the GS1 DataBar Omnidirectional base label will be decoded and transmitted regardless of the state of the linkage flag.

	Disable GS1 DataBar Omnidirectional 2D Component DEFAULT
Enable GS1 DataBar Omnidirectional 2D Component	

### Disable/Enable GS1 DataBar Expanded 2D Component

When enabled, if a GS1 DataBar Expanded label is decoded which has the 2D linkage flag set, the 2D component must also be decoded or the base label will be discarded.

When disabled, only the GS1 DataBar Expanded base label will be decoded and transmitted regardless of the state of the linkage flag.

	Disable GS1 DataBar Expanded 2D Component DEFAULT
Enable GS1 DataBar Expanded 2D Component	



### Disable/Enable GS1 DataBar Limited 2D Component

When enabled, if a GS1 DataBar Limited label is decoded which has the 2D linkage flag set, the 2D component must also be decoded or the base label will be discarded.

When disabled, only the GS1 DataBar Limited base label will be decoded and transmitted regardless of the state of the linkage flag.



Disable GS1 DataBar Limited 2D Component  
DEFAULT

Enable GS1 DataBar Limited 2D Component







# Chapter 7

## Advanced Decoding Features

### Pharmacy Patterns

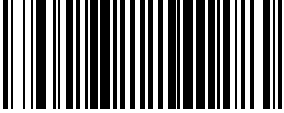
Enables/disables using the pharmacy patterns.

	START / END
PROGRAMMING BAR CODES	
	Pharmacy Patterns = Disable DEFAULT
Pharmacy Patterns = Enable	



#### NOTE

Pharmacy patterns are VSL (1D) patterns that are almost exclusively in the fence orientation. This loses almost all omni capability, but gains a much denser fence pattern and gives a much better ability to read highly truncated and small 1D bar codes.



## Inverse Label Reading

This controls the method of reading inverse labels (white label on black background).



**This feature is only available for GS1 DataBar and 2D symbologies.**

### NOTE

	2D Read Mode = Reads only normal labels DEFAULT
2D Read Mode = Reads both normal and inverse labels	
	2D Read Mode = Reads only inverse labels



## Chapter 8 References

This section contains explanations and examples of selected bar code features. See the programming sections for the actual bar code labels used to configure the reader.

## Global Prefix/Suffix

Up to 20 ASCII characters may be added as a prefix (in a position before the bar code data) and/or as a suffix (in a position following the bar code data) as indicated in Figure 3.

Figure 3. Prefix and Suffix Positions

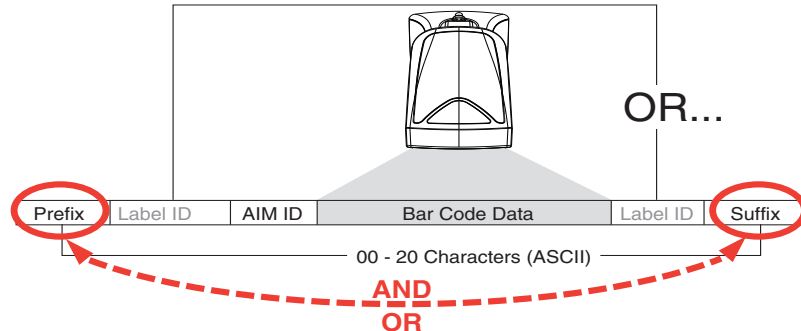

### Example: Setting a Prefix

In this example, we'll set a prefix for all symbologies.

1. Determine which ASCII character(s) are to be added to scanned bar code data. In this example, we'll add a dollar sign ('\$') as a prefix.
2. Scan the START bar code.
3. Scan the SET PREFIX bar code.
4. Reference the [ASCII Character Set on page 159](#) on the inside back cover of this manual, to find the hex value assigned to the desired character. The corresponding hex number for the '\$' character is 24. To enter this selection code, scan the '2' and '4' bar codes from [Appendix C, Alphanumeric Pad](#).
5. Scan the END bar code once to finish the string, then scan END again to exit Programming Mode.



#### NOTE

**If all 20 characters will be used in the prefix or suffix, do not scan the END bar code to finish the string. It is done automatically.**

6. The resulting message string would appear as follows:

Scanned bar code data:12345

Resulting message string output: \$12345

## Label ID

A Label ID is used to identify a bar code (symbology) type. See [Appendix D, Default Settings](#), for a listing for common symbologies. It can be appended previous to or following the transmitted bar code data depending upon how this option is enabled. This feature provides options for configuring custom Label IDs individually per symbology. If you wish to program the scanner to always include an industry standard label identifier for ALL symbology types, see the feature, [AIM ID](#).

The Label ID is a customizable code of up to four ASCII characters (each of which are 00–7F) followed by a control character (00–01). This control character, when set to zero, does nothing. When set to one, it appends the symbology's AIM ID to the Label ID.



### NOTE

When the control character is set to 01 for UPC-A and UPC-E, it expands the label to EAN-13 and thus follows the EAN-13 Label ID settings.

To configure a Label ID:

1. Scan the START bar code.
2. Select Label ID position as either BEFORE or AFTER by scanning the appropriate bar code.
3. Scan a bar code to select the symbology for which you wish to configure a custom Label ID.
4. Determine the desired character(s) (you may choose up to three) which will represent the Label ID for the selected symbology. Next, turn to the [ASCII Character Set on page 159](#) on the inside back cover of this manual and find the equivalent hex digits associated with your choice of Label ID. For example, if you wish to select an equal sign (=) as a Label ID, the chart indicates its associated hex characters as 3D.
5. Turn to [Appendix C, Alphanumeric Pad](#) and scan the bar codes representing the hex characters determined in the previous step. For example, to make an equal sign (=), scan '3' and 'D' followed by '0' six times. Since this is a three-character buffer, '00' is scanned for character two, '00' for character three and '00' for the control character. ('00' indicates no character.)
6. Scan the END bar code to exit programming mode.

**Figure 4. Label ID Position Options**

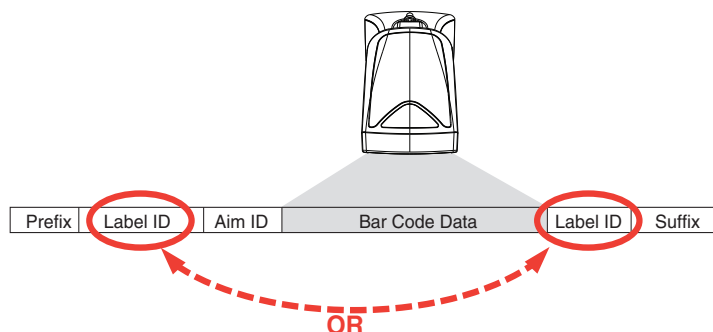

---

## Length Control

**Fixed Length Decoding** — When fixed length decoding is enabled, the scanner will decode a bar code if the label length matches one of the configurable fixed lengths.

**Variable Length Decoding** — When variable length decoding is enabled, the scanner will decode a bar code if the label length falls in the range of the configurable minimum and maximum length.

Configuring Fixed Length Decoding:

1. Scan the START/END bar code.
2. Scan the Fixed Length Decoding bar code for the desired symbology.
3. Scan the START/END bar code.
4. Set Length 1 to the first fixed length by following the [Length 1, Length 2 Programming Instructions](#) below.
5. Set Length 2 to the second fixed length (or to '00' if there is only one fixed length) by following the [Length 1, Length 2 Programming Instructions](#) below.

Configuring Variable Length Decoding:

1. Scan the START/END bar code.
2. Scan the Variable Length Decoding bar code for the desired symbology.
3. Scan the START/END bar code.
4. Set Length 1 to the first variable length by following the [Length 1, Length 2 Programming Instructions](#) below.
5. Set Length 2 to the second variable length by following the [Length 1, Length 2 Programming Instructions](#) below.

## Length 1, Length 2 Programming Instructions

1. Scan the START/END bar code.
2. Scan either the Set Length 1 or Set Length 2 bar code for the desired symbology.
3. Turn to [Appendix C, Alphanumeric Pad](#) and scan the two digits (zero padded) representing the length in decimal notation. The number of characters that can be set varies, depending upon the symbology. Reference the page for your selected symbology to see specific variables.
4. Scan the START/END bar code





# Appendix A

## Product Specifications

### Optical and Read Performance Parameters

Parameter	Specification
Scan Volume	60 cubic inches
Scan Pattern	140 Scan Lines <sup>a</sup>
Scan Rate	~1456 scan lines/second <sup>a</sup>
Minimum Resolution	5 mil
Depth of Field (100% UPC Labels)	0 - 5.5"
Minimum Print Contrast Ratio	25%
Skew (Yaw)	± 60°
Pitch	± 60°
Roll	Between 0 and 360°

a. These stats decline in Pharmacy Mode.

# Scanner Dimensions

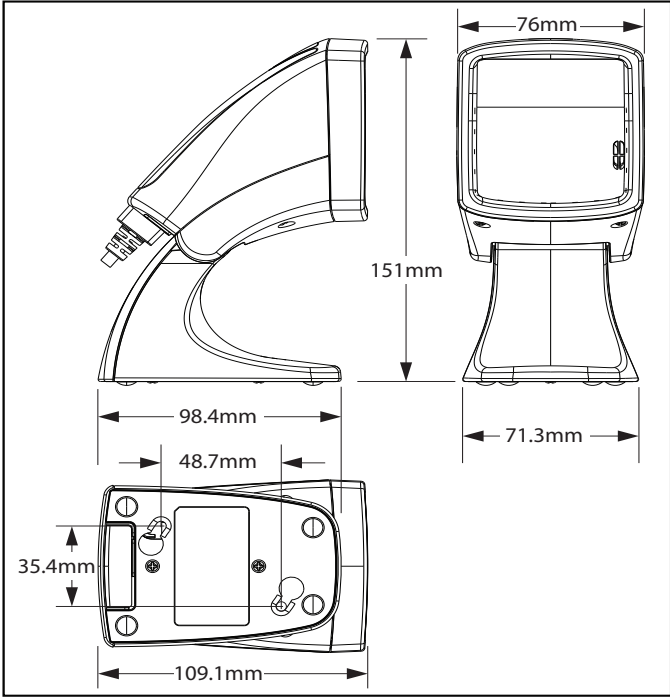

## Physical Properties

Parameter	Specification
Dimensions (Scanner w/ Base Station):	76mm x 151mm x 109.1mm
Weight	10.5 oz.

## Electrical Parameters

Parameter	Specification
Operating Voltage	Input voltage 4.5 to 5.5 VDC
Input Current	
Operating (idle)	<350mA
Operating (label read)	<400 mA

## Environmental Parameters

Parameter	Specification
Mechanical Shock	Multi 1.2m drops
Contaminants Water and Dust	IP52
Temperature Ranges:	
Operating	32° F to +104° F (0° C to +40° C)
Storage	-40° F to +158° F (-40° C to + 70°C)
Ambient Light Indoor	0 - 6000 lux
Ambient Light Outdoor	0 - 86,100 lux
Humidity	5 to 95% non-condensing
Beeper/Speaker	70-85dBA at a distance of 3'-3" (1 meter)
Vibration	Retail/Office

## Other Parameters

Parameter	Specification
EAS Support	YES (Checkpoint)

---

# NOTES



# Appendix B Cable Pinouts

## Standard Cable Pinouts (Primary Interface Cables)

### RS-232

- 1
- 2 CTS
- 3
- 4 RTS
- 5 RXD
- 6 TXD
- 7
- 8 VCC IN (5V ONLY)
- 9 GND
- 10

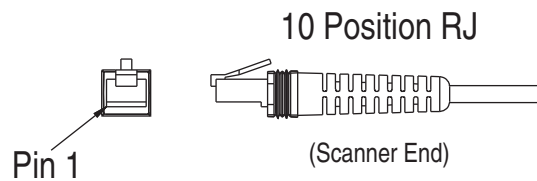

---

## USB-OEM, USB Keyboard, USB COM & USB TEC

1 D+

2

3 D-

4

5

6

7

8 VBUS\_VIN

9 GND

10

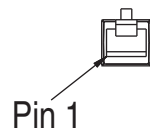

10 Position RJ



(Scanner End)

## External Read Indicator (ERI)



This feature is available only through use of a special cable.

### NOTE

1

2

3

4

5

6

7 ERI\_OUT

8 VCC\_IN (5V ONLY)

9 GND

10



## Appendix C Alphanumeric Pad



A



**NOTE**

For numeric entry sequences, the scanner will announce the number of digits remaining to be entered after each label read.



B



C



D



E



F



---

## Alphanumeric Pad



1



2

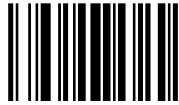

3



4

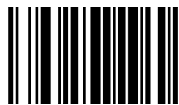

5

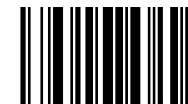

6



7



8



9



0

---

# NOTES



# Appendix D

## Default Settings

### Defaults by Symbology

The following is a partial list of key settings for each symbology type.

Code Type	Read Enable	Checksum Verification Enable	Checksum Transmission Enable	Label ID
UPC-A	?	?	?	A
UPC-E	?	?	?	E
EAN-13	?	?	?	F
EAN-8	?	?	?	FF
GS1 DataBar Omnidirectional				R4
GS1 Expanded				RX
Code 39	?		?	*
PharmaCode 39				A
Code 128	?			#
Interleaved 2 of 5			?	i
Codabar			?	%
Code 93				&
MSI/Plessey			?	@
Standard 2 of 5			?	s
PDF 417				P
Micro PDF 417	?			mP
Datamatrix				Dm

<b>Code Type</b>	<b>Read Enable</b>	<b>Checksum Verification Enable</b>	<b>Checksum Transmission Enable</b>	<b>Label ID</b>
QR Code				QR
Maxicode				MC
Aztec				Az
GS1 DataBar Omnidirectional 2D Composite				R4
GS1 DataBar Expanded 2D Composite				RX
GS1 DataBar Limited 2D Composite				RL

## Interface Default Exceptions

The factory default settings indicated in the programming sections (in bold text) reflect factory configuration for the RS-232 standard interface. The following tables list default exceptions by interface for the remaining available interfaces.

### RS-232 Wincor/Nixdorf

<b>Parameter</b>	<b>Default Setting</b>
Interface Type	RS-232-WN
Number of Host Transmit Buffers	One Buffer
RS-232 Parity	Odd
RS-232 Hardware Control	CTS Flow Control
UCC/EAN-128 Label ID	'P'
Code 39 Label ID	'M'
Code 93 Label ID	'L'
Code 128 Label ID	'K'
Codabar Label ID	'N'
EAN-8 Label ID	'B'
EAN-13 Label ID	'A'
ISBN Label ID	'A'
Interleaved 2 of 5 Label ID	'I'
Standard 2 of 5 Label ID	'H'
MSI/Plessey Label ID	'O'
UPC-E Label ID	'C'
GS1 DataBar Omnidirectional Label ID	'E'
GS1 Expanded Label ID	'E'

### USB Keyboards

<b>Parameter</b>	<b>Default Setting</b>
Label ID Transmission	Disable

---

# NOTES



# Appendix E

## USB Keyboard Function Key Mappings

### USB Function Key Usage Map

ASCII	Key value	Usage Name	Modifier/ Scancode
00	NUL	ALT right Make	40h 00h
01	SOH	ALT right Break	00h 00h
02	STX	F11	00h 44h
03	ETX	F12	00h 45h
04	EOT	GUI right Make	80h 00h
05	ENQ	GUI right Break	00h 00h
06	ACK	CTRL right Make	10h 00h
07	BEL	CTRL right Break	00h 00h
08	BS	BS	00h 2Ah
09	HT	TAB right	00h 2Bh
0A	LF	RIGHT arrow (inner keypad)	00h 4Fh
0B	VT	TAB left	02h 2Bh
0C	FF	Enter (right keypad)	00h 58h
0D	CR	CR	00h 28h
0E	SO	INSERT (inner keypad)	00h 49h
0F	SI	PAGE UP (inner keypad)	00h 4Bh
10	DLE	PAGE DOWN (inner keypad)	00h 4Eh
11	DC1	HOME (inner keypad)	00h 4Ah
12	DC2	LEFT arrow (inner keypad)	00h 50h
13	DC3	DOWN arrow (inner keypad)	00h 51h
14	DC4	UP arrow (inner keypad)	00h 52h
15	NAK	F6	00h 3Fh
16	SYN	F1	00h 3Ah
17	ETB	F2	00h 3Bh
18	CAN	F3	00h 3Ch
19	EM	F4	00h 3Dh
1A	SUB	F5	00h 3Eh
1B	ESC	ESC	00h 29h
1C	FS	F7	00h 40h
1D	GS	F8	00h 41h
1E	RS	F9	00h 42h
1F	US	F10	00h 43h

---

# NOTES





## Appendix F Host Commands

### Host Commands Supported by RS-232 and USB COM Interfaces

The scanner responds to the following host commands:

COMMAND	ASCII	HEX	COMMENT
Enable Scanner	E	0x45	'Normal operating mode'
Disable Scanner	D	0x44	'Illumination disabled and Green LED Flashing'
Reset Scanner	R	0x52	'Scanner resets and emits a single beep.'
Not On File Indication	F	0x46	'Illumination disabled, scanner emits 3 beeps. Must send the E command to re-enable scanner.'
Beep Good Read Tone	B	0x42	Beeps if Good Read Beep is enabled
Force Good Read Tone	{SOH}	0x01	Beeps regardless of beep setting
Identification request	i	0x69	'Scanner transmits information data string' <sup>a</sup>
Health request	h	0x68	'Scanner transmits information data string' <sup>a</sup>
Status request	s	0x73	'Scanner transmits information data string' <sup>a</sup>
Cell Phone Mode Enable Host P<count>C			
<b>Where:</b>	<b>ASCII</b>	<b>HEX</b>	
P is an ASCII 'P' character	'P'	0x50	
<count> is the binary value of 0x01			

COMMAND	ASCII	HEX	COMMENT
C is an ASCII 'C' character	'C'	0x43	
Image Capture <P><\x04><p><S><B><C>			
<b>Where:</b>	<b>ASCII</b>	<b>HEX</b>	
<P>: Host Command Preamble Character	'P'	0x50	
0x04: Byte Count. (Fixed Value).		0x04	
<p>: Image Capture Command Character	'p'	0x70	
<S>: Size (640x480 only)	'S'	0x53	
<B>: Brightness.	'B' or '0' (min) - '9' (max)	0x42 or 0x30 - 0x39	Where 'B' = Scanner Configuration Value.
<C>: Contrast	'C' or '0' (min) - '9' (max)	0x42 or 0x30 - 0x39	Where 'C' = Scanner configuration Value.
Refer to the <cross-ref> 'Image Capture' section on page -21 for more information on image capturing features and settings.			

- a. Call Tech Support for information.

If one of the above commands is received, the scanner will perform the steps indicated for the command. Additional host commands are available. Contact Tech Support for more details.



# Appendix G Sample Symbols

## 1D Symbol Samples

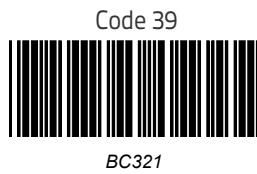
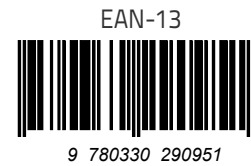
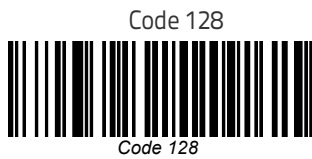
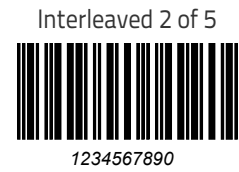
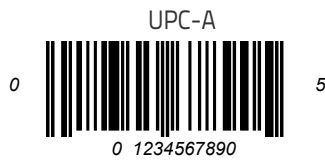

---

## 2D Sample Symbols

Standard 2 of 5

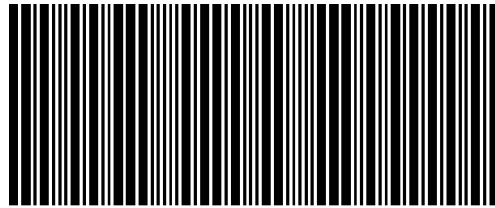

1234567895

GS1 DataBar Omnidirectional



(01)00123456789012

GS1 DataBar Expanded



0100123456789050

GS1 DataBar Limited

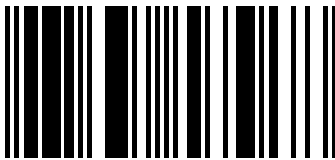

(01)16543210987654

# Composite Sample Symbols

PDF 417

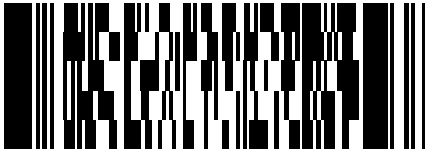

A12B3C

Micro PDF 417



BV17453

Datamatrix

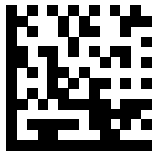

1314H17LL

QR Code

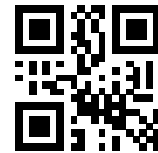

35900G9

Maxicode

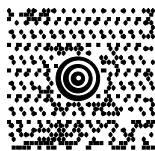

111TUVCCIUL7-1

Aztec



This is an Aztec Code

---

GS1 DataBar Limited Composite

(17) 050923 (10) ABC123



(01) 0 4012345 67890 1

GS1 DataBar Truncated Composite

(17)050923(10)ABC123



(01) 09876543217899

## ASCII Character Set

The table on this page shows a set of ASCII characters and their corresponding Hex Values. The Hex Values in this table are needed for setting symbology specific label identifiers, as well as enabling custom prefix and suffix characters.

ASCII Char.	Hex No.	ASCII Char.	Hex No.	ASCII Char.	Hex No.	ASCII Char.	Hex No.
NUL	00	SP	20	@	40	'	60
SOH	01	!	21	A	41	a	61
STX	02	"	22	B	42	b	62
ETX	03	#	23	C	43	c	63
EOT	04	\$	24	D	44	d	64
ENQ	05	%	25	E	45	e	65
ACK	06	&	26	F	46	f	66
BEL	07	'	27	G	47	g	67
BS	08	(	28	H	48	h	68
HT	09	)	29	I	49	i	69
LF	0A	*	2A	J	4A	j	6A
VT	0B	+	2B	K	4B	k	6B
FF	0C	,	2C	L	4C	l	6C
CR	0D	-	2D	M	4D	m	6D
SO	0E	.	2E	N	4E	n	6E
SI	0F	/	2F	O	4F	o	6F
DLE	10	0	30	P	50	p	70
DC1	11	1	31	Q	51	q	71
DC2	12	2	32	R	52	r	72
DC3	13	3	33	S	53	s	73
DC4	14	4	34	T	54	t	74
NAK	15	5	35	U	55	u	75
SYN	16	6	36	V	56	v	76
ETB	17	7	37	W	57	w	77
CAN	18	8	38	X	58	x	78
EM	19	9	39	Y	59	y	79
SUB	1A	:	3A	Z	5A	z	7A
ESC	1B	;	3B	[	5B	{	7B
FS	1C	<	3C	\	5C		7C
GS	1D	=	3D	]	5D	}	7D
RS	1E	>	3E	^	5E	~	7E
US	1F	?	3F	_	5F	DEL	7F



©2011-2017 Datalogic S.p.A. and its Group companies ▪ All rights reserved. ▪ Protected to the fullest extent under U.S. and international laws. ▪ Copying or altering of this document is prohibited without express written consent from Datalogic S.p.A. ▪ Datalogic and the Datalogic logo are registered trademarks of Datalogic S.p.A. in many countries, including the U.S. and the E.U.



[www.datalogic.com](http://www.datalogic.com)

**Datalogic USA, Inc.**

959 Terry Street | Eugene | OR 97402 | USA  
Telephone: (1) 541-683-5700 | Fax: (1) 541-345-7140

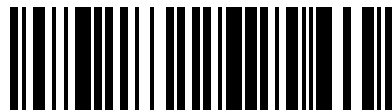

820035014 (Rev.E) Jan 2017