



**A30**  
**QuickStart Guide**

Publication # 821002024 (Rev D)

DATALOGIC S.r.l.  
Via S. Vitalino 13 - 40012 Calderara di Reno - Italy  
www.datalogic.com

A30™ QuickStart Guide

Edited: 7-Jun-17

© 2013 - 2017 • Datalogic S.p.A. and/or its affiliates • All rights reserved. • Without limiting the rights under copyright, no part of this documentation may be reproduced, stored in or introduced into a retrieval system, or transmitted in any form or by any means, or for any purpose, without the express written permission of Datalogic S.p.A. and/or its affiliates • Datalogic and the Datalogic logo are registered trademarks of Datalogic S.p.A. in many countries, including the U.S. and the E.U. • Impact, P-Series, Vision Program Manager (VPM), Pinpoint Pattern Find, and Control Panel Manager (CPM) are trademarks of Datalogic S.p.A. and/or its affiliates, registered in many countries, including the U.S. and the E.U. • All other trademarks and brands are property of their respective owners.

Datalogic reserves the right to revise this publication from time to time and to make changes in the content hereof without obligation to notify any person of such revision or changes.

Printed 7 June 2017

## REFERENCES

---

### CONVENTIONS

This manual uses the following conventions:

"User" refers to anyone using an A30 camera.

"Camera" refers to an A30 camera.

"You" refers to the System Administrator or Technical Support person using this manual to install, configure, operate, maintain, or troubleshoot an A30 camera.

### REFERENCE DOCUMENTATION

For further details refer to the Impact Reference Guide provided as supplementary documentation on the Datalogic web site ([www.datalogic.com](http://www.datalogic.com)).

### PATENTS

Patent. See [www.patents.datalogic.com](http://www.patents.datalogic.com) for patent list.

This product is covered by one or more of the following patents:

Utility patents: EP0996284B1, EP0999514B1, EP1014292B1, EP1128315B1, EP1396811B1, EP1413971B1, JP4435343B2, JP4571258B2, US6512218, US6616039, US6808114, US6997385, US7053954, US7387246, US8058600, US8368000

### SUPPORT THROUGH THE WEBSITE

Datalogic provides several services as well as technical support through its website. Log on to [www.datalogic.com](http://www.datalogic.com) and click on the **SUPPORT** > **Machine Vision** category link. From this page you can select your product model from the dropdown list which gives you access to:

- [Downloads](#) including Data Sheets, Manuals, Software & Utilities, and Drawings;
- [Repair Program](#) for On-Line Return Material Authorizations (RMAs) plus Repair Center contact information;
- [Service Program](#) containing details about Maintenance Agreements;
- [Technical Support](#) through email or phone.

## **COMPLIANCE**

---

For installation, use, and maintenance, it is not necessary to open the camera. Opening the camera will void the warranty.

Connect Ethernet and dataport connections to a network which has routing only within the plant or building and no routing outside the plant or building.

### **EAC COMPLIANCE**

Customs Union:

The CU Conformity certification has been achieved; this allows the Product to bear the Eurasian mark of conformity.

### **EMC COMPLIANCE**

In order to meet the EMC requirements:

- connect the camera chassis to the plant earth ground by means of a flat copper braid shorter than 100 mm;
- for CBX connections, connect the pin "Earth" to a good Earth Ground;
- for direct connections, connect the main interface cable shield to pin K of the 19-pin connector.

### **POWER SUPPLY**

ATTENTION: READ THIS INFORMATION BEFORE INSTALLING THE PRODUCT

This product is intended to be installed by Qualified Personnel only.

This product is intended to be connected to a UL Listed Direct Plug-in Power Unit marked LPS or "Class 2", rated 10-30Vdc 1-0.33A.

### **CE COMPLIANCE**

CE marking states the compliance of the product with essential requirements listed in the applicable European directive. Since the directives and applicable standards are subject to continuous updates, and since Datalogic promptly adopts these updates, therefore the EU declaration of conformity is a living document. The EU declaration of conformity is available for competent authorities and customers through Datalogic commercial reference contacts. Since April 20th, 2016 the main European directives applicable to Datalogic products require inclusion of an adequate analysis and assessment of the risk(s). This evaluation was carried out in relation to the applicable points of the standards listed in the Declaration of Conformity. Datalogic products are mainly designed for integration purposes into more complex systems. For this reason it is under the responsibility of the system integrator to do a new risk assessment regarding the final installation.

### **WARNING**

This is a Class A product. In a domestic environment this product may cause radio interference in which case the user may be required to take adequate measures.

### **FCC COMPLIANCE**

Modifications or changes to this equipment without the expressed written approval of Datalogic could void the authority to use the equipment.

## COMPLIANCE

---

This device complies with PART 15 of the FCC Rules. Operation is subject to the following two conditions: (1) This device may not cause harmful interference, and (2) this device must accept any interference received, including interference which may cause undesired operation.

This equipment has been tested and found to comply with the limits for a Class A digital device, pursuant to part 15 of the FCC Rules. These limits are designed to provide reasonable protection against harmful interference when the equipment is operated in a commercial environment. This equipment generates, uses, and can radiate radio frequency energy and, if not installed and used in accordance with the instruction manual, may cause harmful interference to radio communications. Operation of this equipment in a residential area is likely to cause harmful interference in which case the user will be required to correct the interference at his own expense.

## GENERAL VIEW

### A30™ Camera

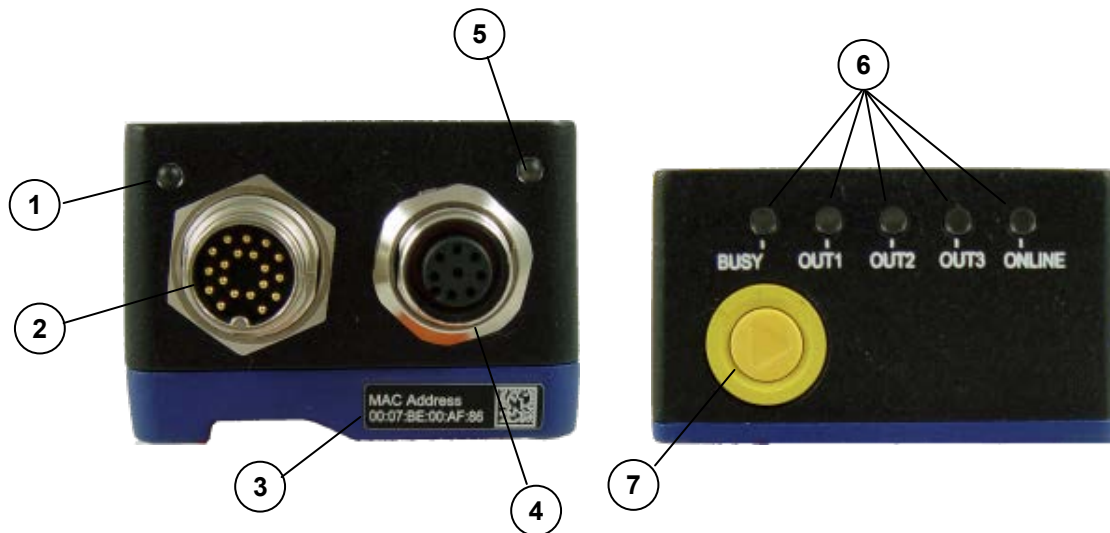

1	Power Indicator LED
2	Power, Serial Interface, and I/O Connector
3	MAC Address label
4	Ethernet Connector
5	Ethernet Network Presence LED
6	Indicator Lights (see page 8)
7	Reset and Camera Button Event (see page 8)

## Configuration

### ASSEMBLE THE CAMERA

The first step to perform is to assemble any accessories that make up the A30™ camera. A lens must be used. A strobe or other external illuminator may be required.



*The camera must be disconnected from the power supply during this procedure.*

1. In a dust-free environment, remove the Camera Lens Cover by unscrewing it.



*Do not touch the sensor aperture, lens glass or lens cover glass. These areas must be kept clean. Avoid any abrasive substances that might damage these surfaces during cleaning.*

2. Remove the sensor protection label (dust cap) by pulling it off of the base.
3. Mount a lens by slowly screwing it onto the base until it arrives at the mechanical stop.

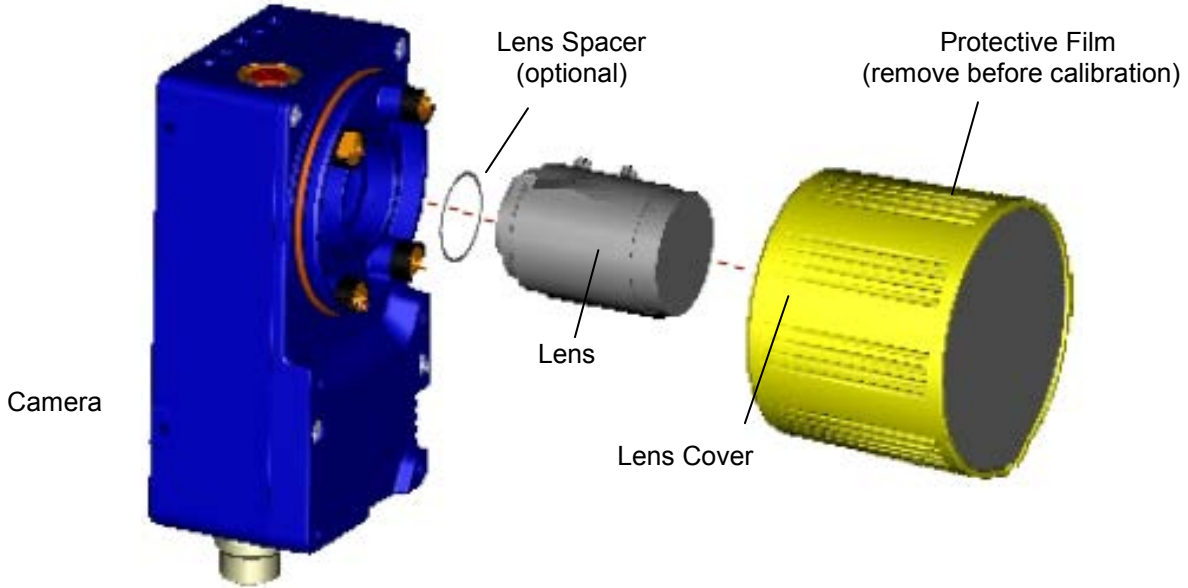

Figure 1 – Assembling the Camera and Lens

4. To keep dust and dirt off of the lens during mounting, temporarily replace the lens cover.

## Install the Host Software

All necessary firmware is installed on the A30 camera at the factory. Vision Program Manager (VPM) software must be installed on a host PC to configure the camera inputs, strobe, and general purpose outputs. See Installing Impact Software on page 20. Machine Vision installation software can be downloaded from the Datalogic web site ([www.datalogic.com](http://www.datalogic.com)). Refer to the Impact Reference Guide for programming details.

## Connect the System

In the typical standalone layout shown in the figure below, an Ethernet host is connected to the camera. The camera can use an external trigger to signal image acquisition.

The CBX is used to facilitate the connection between the camera and the host interface, external trigger, and optional input and output devices. Alternate connections may be made using a terminal block. (See “TERMINAL BLOCK ELECTRICAL CONNECTIONS” on page 12.)

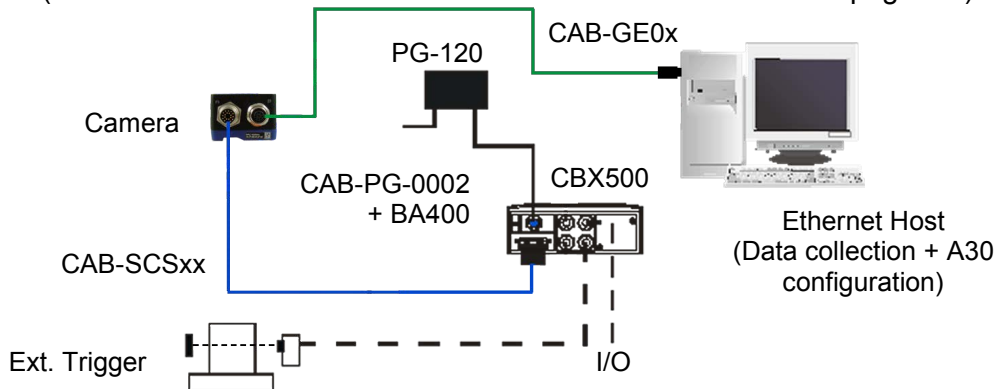

A30™ Standalone Layout to Ethernet Host



- **Power Supply Connection**

Use the PG-120 power Kit (3 versions for European, UK or US plug) and CAB-PG-0002 + BA400 connector to connect the PG-120 to the CBX. An alternative power supply to the PG-120 is the PWR-120.

- **CBX Connection**

Use CAB-SCSxx between the A30 camera and the CBX for power, external trigger device (photocell), and additional I/O connections.

Use the CAB-GE0x for the Gigabit Ethernet connection to the host.

 <b>NOTE</b>	<p>The A30 does not support sourcing power towards the CBX in order to power I/O devices. These devices must be powered through the CBX or from an external source.</p>
 <b>CAUTION</b>	<p>Do not connect GND and SGND to different (external) ground references. GND and SGND are internally connected through filtering circuitry which can be permanently damaged if subjected to voltage drops over 0.8 Vdc.</p>

## INDICATORS AND KEYPAD BUTTON

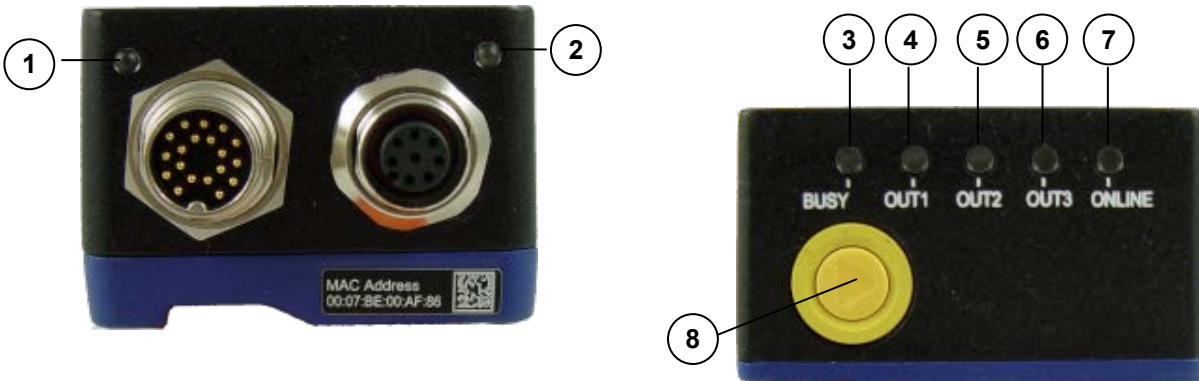

**Figure 2 - Indicators**

The following LED indicators are located on the camera (Figure 2):

<b>1</b>	<b>POWER</b>	On – camera is connected to power
<b>2</b>	<b>NET</b>	On – Ethernet link is established. Blinking - data transmission
<b>3</b>	<b>BUSY</b>	LED blinks during task execution and flash memory access
<b>4</b>	<b>OUT1</b>	On – Output 1 is on
<b>5</b>	<b>OUT2</b>	On – Output 2 is on
<b>6</b>	<b>OUT3</b>	On – Output 3 is on
<b>7</b>	<b>ONLINE</b>	On – Loaded tasks will be executed based on their trigger parameters
<b>8</b>	<b>BUTTON</b>	Camera Reset: See Note below Camera Button event: Press and release the button (Internal software event trigger only)

Note: Camera Reset restores the factory camera settings including deleting all user settings and resetting the camera’s Mask and IP Address to the factory default (192.168.0.128).



## To Reset the Camera

1. Turn off camera power.
2. Press and hold the Camera Reset button.
3. Turn on power. Continue pressing the Camera Reset button.
4. After about 30 seconds, all the LED indicators turn on for a few seconds. Continue pressing the Camera Reset button.
5. The LED indicators turn off for about five seconds, then turn on.
6. When all the LED indicators have turned on and remain lit, release the Camera Reset button.
7. Wait approximately 30 seconds for the camera to restart.

## MECHANICAL DIMENSIONS

The A30 can be installed to operate in different positions using the body mounting bracket shown in Figure 4. The twelve screw holes (M4) on the body of the camera can be used for custom mounting solutions.

The diagram below gives the overall dimensions of the camera.

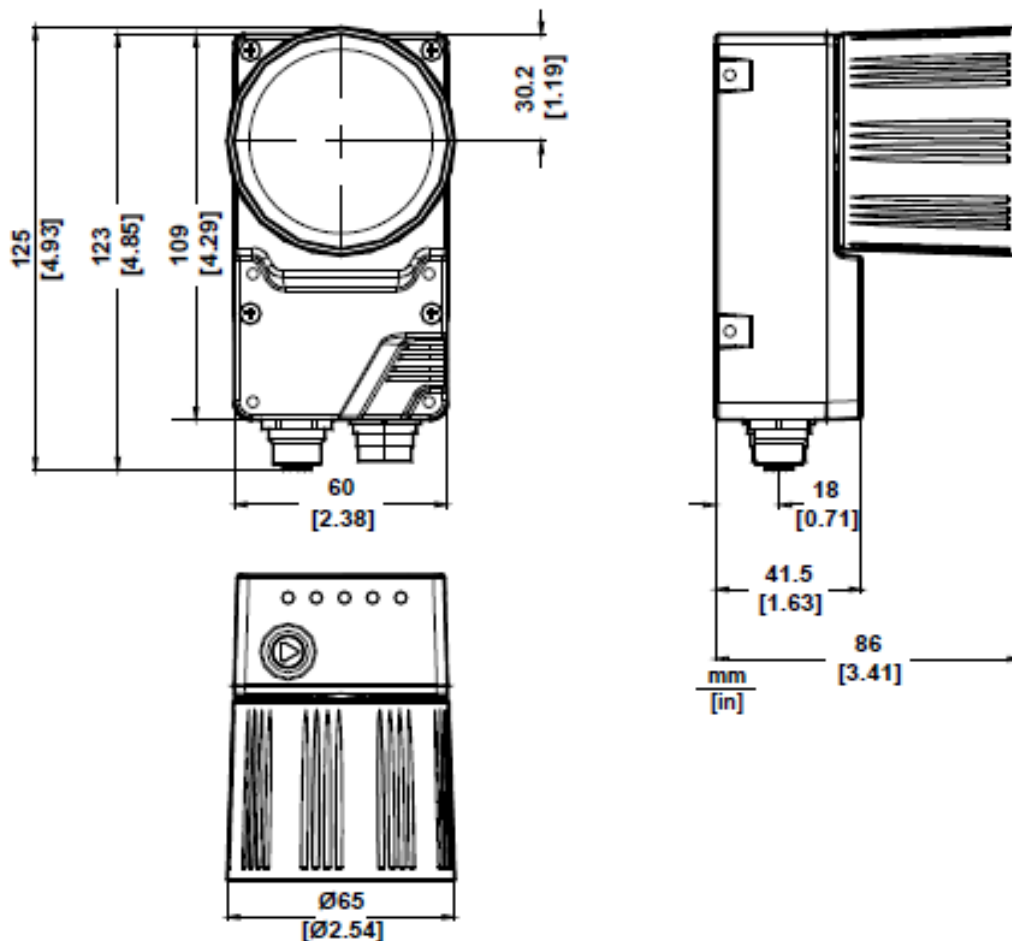

Figure 3 – A30 Overall Dimensions

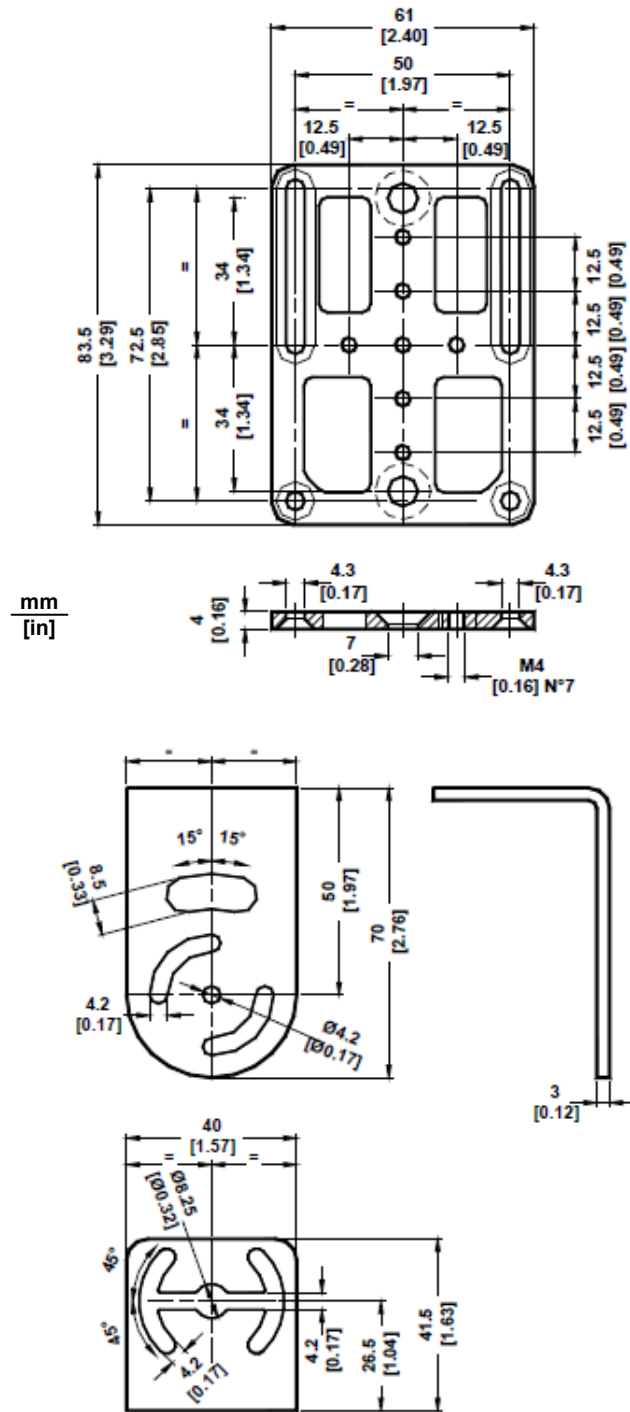

Figure 4 – Mounting Bracket Overall Dimensions

## MOUNTING THE CAMERA

---

Using the A30 mounting brackets, you can obtain rotation on the various axes of the camera as shown in the diagrams below.

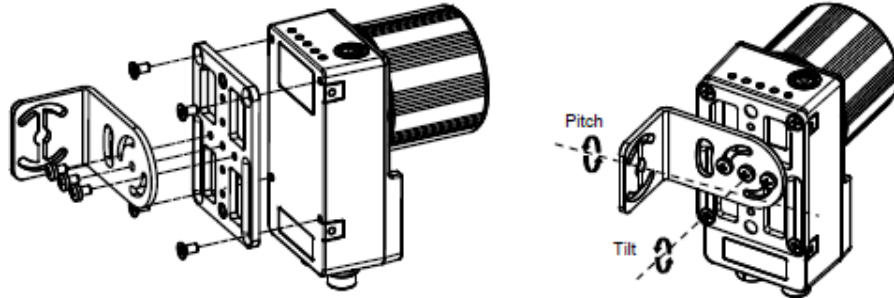

Figure 5 –Positioning with Body Mounting Bracket (Back)

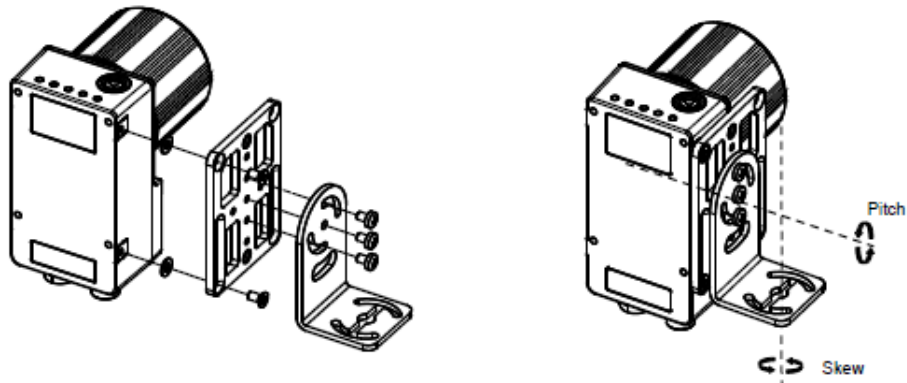

Figure 6 –Positioning with Body Mounting Bracket (Side)

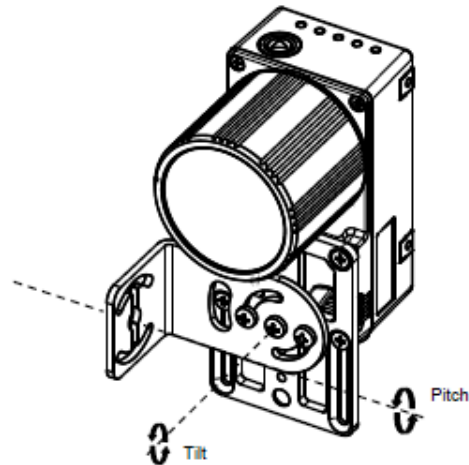

Figure 7 –Positioning with Body Mounting Bracket (Front)

## TERMINAL BLOCK ELECTRICAL CONNECTIONS

Camera power, trigger signals, and strobe triggers can be connected to the camera using a CBX500 connection box, terminal block and cable, or an unterminated cable. To use a terminal block (95A906346) you must also use the optional camera cable (CAB-SCSxx). **The camera cannot source power through this connector.**

We recommend making system connections through a CBX connection box since it offers the advantages of easy connection, easy device replacement, and filtered reference signals (see page 13).

Figure 8 – A30/T4x-Series I/O Block



Terminal	Name	Function
9 & 13	Vdc	Power supply input voltage +
7 & 25	GND	Power supply input voltage -
18	I1A	External Trigger + or - (polarity insensitive)
19	I1B	External Trigger + or - (polarity insensitive)
6	I2A	I2: Input 2 + or - (polarity insensitive)
10	I2B	I2: Input 2 + or - (polarity insensitive)
22	O1-	Output 1 -
11	O2+	Output 2 +
8	O1+	Output 1 +
12	O2-	Output 2 -
2	TX	RS232 Transmit
3	RX	RS232 Receive
4	Not Used	Not Used
5	Not Used	Not Used
21	Not Used	Not Used
20	Not Used	Not Used
17	Strobe-/O3B	Strobe - / Output 3 – (See Note Below)
16	Strobe+/O3A	Strobe + / Output 3 +
1	CHASSIS	Cable shield

Note: The strobe signal connection is shared with Output 3. If a non-zero value is defined for the Strobe Pulse Length value (in VPM – Impact – General), the strobe is active. If the value is zero, Output 3 is active.

## CBX ELECTRICAL CONNECTIONS

All A30 cameras can be connected to a CBX500 connection box using a **CAB-SCSxx** accessory cable. These accessory cables terminate in a 19-pin connector on the camera side and in a 25-pin male D-sub connector on the CBX side.

We recommend making system connections through one of the CBX connection boxes since they offer the advantages of easy connection, easy device replacement, and filtered reference signals.

The table below shows the terminal block connections for the CBX500.

CBX500 Terminal Block Connectors	
<b>Input Power</b>	
Vdc	Power Supply Input Voltage +
GND	Power Supply Input Voltage -
Earth	Protection Earth Ground (See Caution)
<b>Inputs</b>	
+V	Power Source – External Trigger
I1A	External Trigger + or - (polarity insensitive)
I1B	External Trigger + or - (polarity insensitive)
-V	Power Reference – External Trigger
+V	Power Source – Inputs
I2A	Input 2 + or - (polarity insensitive)
I2B	Input 2 + or - (polarity insensitive)
I3A	NOT USED
I4A	NOT USED
I34B	NOT USED
-V	Power Reference – Inputs
<b>Shield</b>	
Shield	Network Cable Shield
<b>Outputs</b>	
+V	Power Source - Outputs
-V	Power Reference - Outputs
O1+	Output 1 +
O1-	Output 1 -
O2+	Output 2 +
O2-	Output 2 -
O3A	Strobe + / Output 3 + (See Note)
O3B	Strobe - / Output 3 -
<b>RS232 Interface</b>	
TX	Transmit
RX	Receive
SGND	Signal Ground (See Caution)

Note: The strobe signal connection is shared with Output 3. If a non-zero value is defined for the Strobe Pulse Length value (in VPM – Impact – General), the strobe is active. If the value is zero, Output 3 is active.

 <b>CAUTION</b>	<p><i>Do not connect GND and SGND to different (external) ground references. GND and SGND are internally connected through filtering circuitry which can be permanently damaged if subjected to voltage drops over 0.8 Vdc.</i></p>
---	---

**NOTE**  To avoid electromagnetic interference when the camera is connected to a CBX connection box, verify the jumper positions in the CBX as indicated in its Installation Manual.

## POWER SUPPLY

**NOTE**  The A30 does not support sourcing power towards the CBX through the CBX "power from device" source jumper setting. Power must be supplied to the CBX as shown below.

To power the camera and/or I/O devices through the CBX, power must be supplied to the CBX500 spring clamp terminal pins as shown in Figure 9:

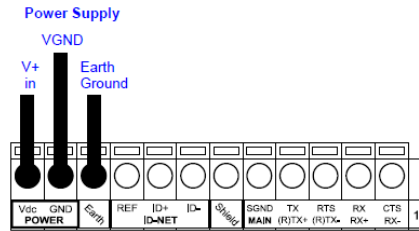

**Figure 9 - Power Supply Connections**

The power must be between 10 and 30 Vdc only.

It is recommended to connect the device CHASSIS to earth ground (Earth) by setting the appropriate jumper in the CBX connection box. See the CBX Installation Manual for details.

## RS232 SERIAL INTERFACE

The signals relative to the following serial interface types are available on the CBX spring clamp terminal blocks.

The serial interface parameters (baud rate, data bits, etc.) are defined in Vision Program Manager (VPM) software. Refer to the Serial Port section of the Impact Reference Guide (Publication # 843-0093).

The following pins are used for RS232 interface connection. The Impact software does not support hardware (CTS/RTS) or software (Xon/Xoff) data flow control.

CBX500	Function
TX	Transmit Data
RX	Receive Data
SGND	Signal Ground

It is always advisable to use shielded cables. The overall maximum cable length must be less than 15 m (49.2 ft.).

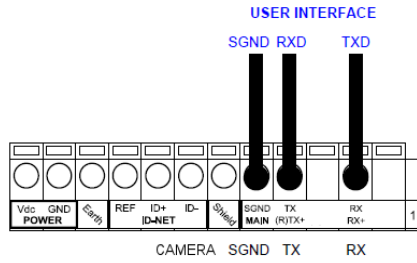

Figure 10 – RS232 Main Interface Connections Using Hardware Handshaking

## INPUTS

There are two optocoupled polarity insensitive inputs available on the camera: Input 1 (Trigger) and Input 2, a generic input:

The Trigger is used to trigger the camera so that it will acquire an image.

Input 2 can be used as a signal to a software task to perform an action.

The electrical features of both inputs are:

$$V_{AB} = 30 \text{ Vdc max.}$$

$$I_{IN} = 10 \text{ mA (camera) + 12 mA (CBX) max.}$$

The active state of these inputs are selected in software. Refer to the Camera Setup tab and Discrete Input tool sections of the Impact Reference Guide (Publication # 843-0093).

An anti-disturbance filter is implemented in software on both inputs so that the minimum pulse duration is  $\cong 0.5$  milliseconds. This value can be increased through the software parameter Debounce Filter. Refer to the Camera Setup tab section in the Impact Reference Guide for further details.

These inputs are optocoupled and can be driven by both NPN and PNP type commands.



*Polarity insensitive inputs assure full functionality even if pins A and B are exchanged.*

**NOTE**

## EXTERNAL TRIGGER CONNECTIONS

The connections are indicated in the following diagrams:

### EXTERNAL TRIGGER INPUT CONNECTIONS USING CBX POWER

CBX500	Function
+V	Power Source - External Trigger
I1A	External Trigger A (polarity insensitive)
I1B	External Trigger B (polarity insensitive)
-V	Power Reference - External Trigger



**CAUTION**

*Power is available directly to the Input Device, independently from the Power Supply Switch inside the CBX.*

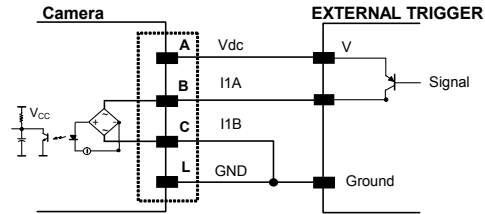
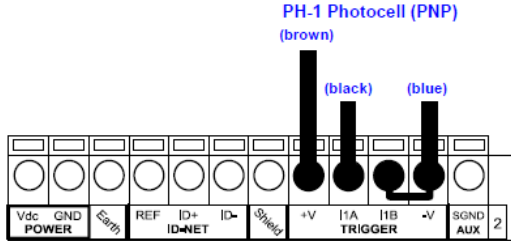

Figure 11 – PH-1 PNP External Trigger

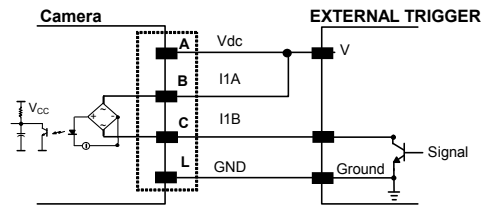
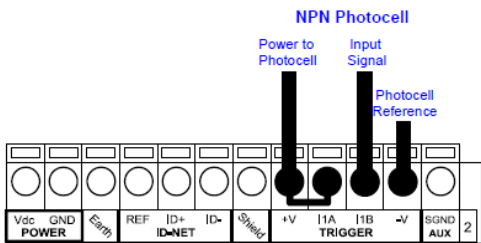

Figure 12 - NPN External Trigger Using CBX Power

**EXTERNAL TRIGGER INPUT CONNECTIONS USING EXTERNAL POWER**

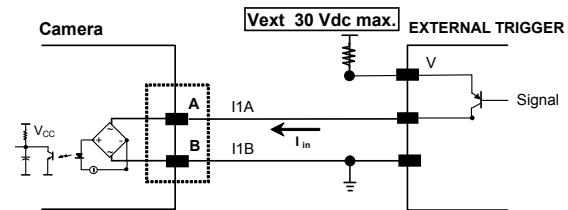
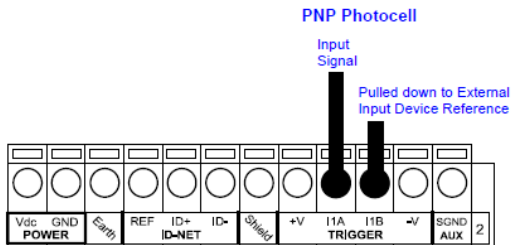

Figure 13 - PNP External Trigger Using External Power

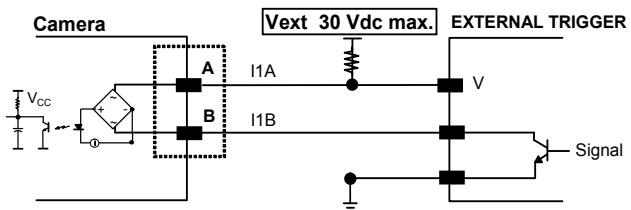
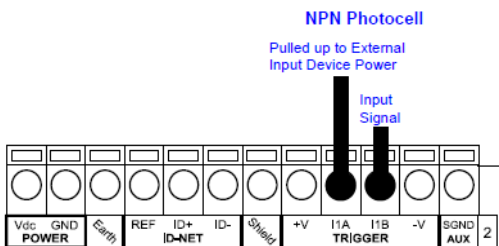



Figure 14 - NPN External Trigger Using External Power



## INPUT 2 CONNECTIONS

### INPUT 2 CONNECTIONS USING CBX POWER

CBX500	Function
+V	Power Source - Inputs
I2A	Input 2 A (polarity insensitive)
I2B	Input 2 B (polarity insensitive)
-V	Power Reference - Inputs



**CAUTION** *Power is available directly to the Input Device, independently from the Power Supply Switch inside the CBX.*

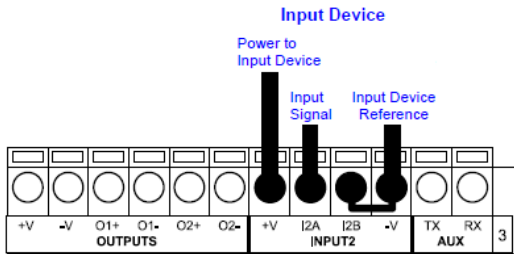

Figure 15 - PNP Input 2 Using CBX Power

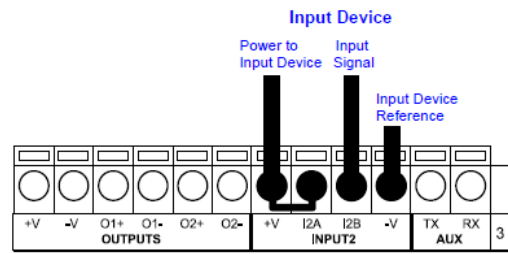

Figure 16 - NPN Input 2 Using CBX Power

### INPUT 2 CONNECTIONS USING EXTERNAL POWER

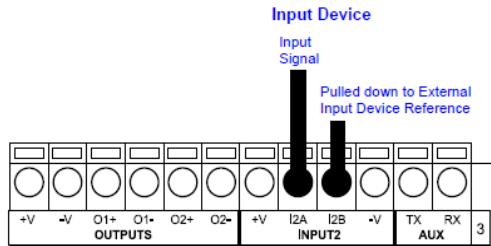

Figure 17 - PNP Input 2 Using External Power

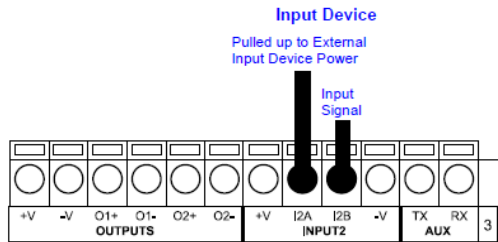
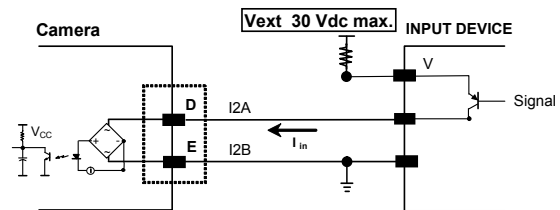
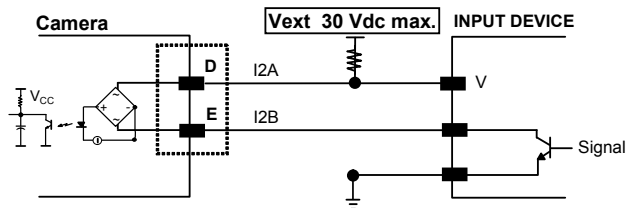

Figure 18 - NPN Input 2 Using External Power



## OUTPUTS

Three optocoupled general purpose outputs are available. The meaning of the outputs can be defined by the user. They are typically used either to signal the data collection result or to control an external lighting system.

The electrical features of the two outputs are the following:

$$V_{CE} = 30 \text{ Vdc max.}$$

$$I_{CE} = 40 \text{ mA continuous max.; } 130 \text{ mA pulsed max.}$$

$$V_{CE \text{ saturation}} = 1 \text{ Vdc max. @ } 10 \text{ mA}$$

$$P_D = 80 \text{ mW Max. @ } 45 \text{ }^\circ\text{C ambient temp.}$$

The output signals are fully programmable. Refer to the Discrete Output tool section in the Impact Reference Guide for further details.

### OUTPUT CONNECTIONS USING CBX POWER

CBX500	Function
+V	Power Source - Outputs
O1+	Output 1 +
O1-	Output 1 -
O2+	Output 2 +
O2-	Output 2 -
O3A	Strobe + / Output 3 + (See Note)
O3B	Strobe - / Output 3 -
-V	Power Reference Outputs

Note: The strobe signal connection is shared with Output 3. If a non-zero value is defined for the Strobe Pulse Length value (in VPM – Impact – General), the strobe is active. If the value is zero, Output 3 is active.



**CAUTION** *Power is available directly to the Output Device, independently from the Power Supply Switch inside the CBX.*

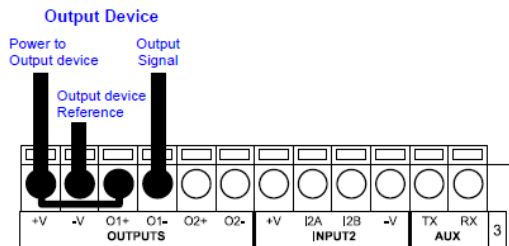

Figure 19 - Open Emitter Output Using CBX Power

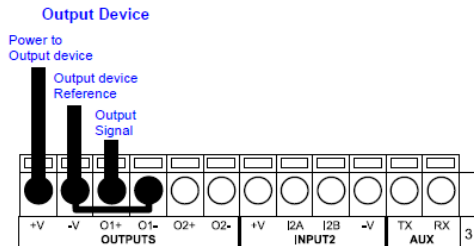

Figure 20 - Open Collector Output Using CBX Power

OUTPUT CONNECTIONS USING EXTERNAL POWER

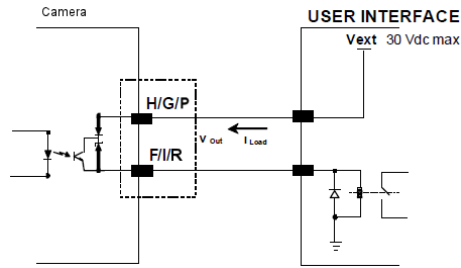
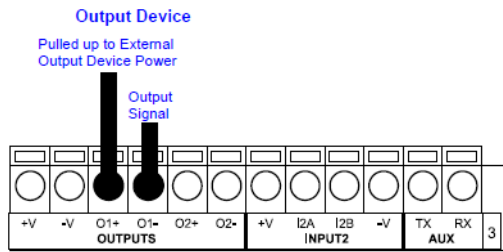

Figure 21 - Output Open Emitter Using External Power

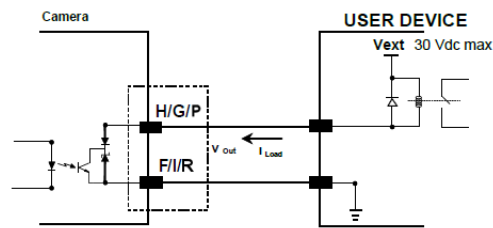
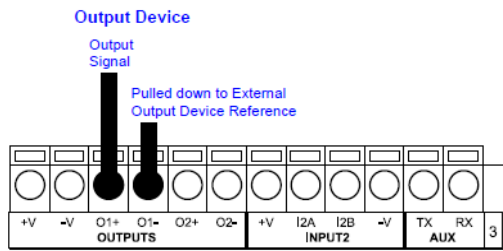



Figure 22 - Output Open Collector Using External Power

EXTERNAL ILLUMINATORS

If an External Illuminator (strobe light) is used, it can be powered from the CBX connection box. It must be connected to the **Vdc** and **GND** terminal clamps. The strobe signal connection is shared with Output 3. If a non-zero value is defined for the Strobe Pulse Length value (in VPM – Impact – General), the strobe is active. If the value is zero, Output 3 is active.



**CAUTION** Power is available directly to the strobe, independently from the Power Supply Switch inside the CBX.

Configure the Strobe Signal in the VPM software. Refer to the Camera Setup tab section of the Impact Reference Guide.

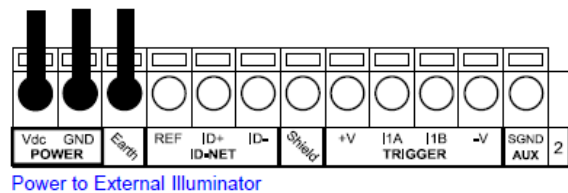
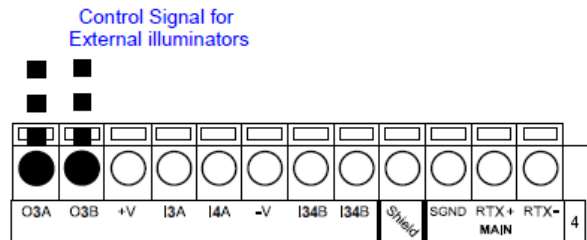

Figure 23 – External Illuminator Connections

This table summarizes the External Illuminator wiring and power requirements.

CBX/Camera Signal	Meaning
Vdc	10 to 30 Vdc
GND	Ground
Earth	Shield/Earth Ground
O3B	Control Signal - (See Note)
O3A	Control Signal +

Note: The strobe signal connection is shared with Output 3. If a non-zero value is defined for the Strobe Pulse Length value (in VPM – Impact – General), the strobe is active. If the value is zero, Output 3 is active.

## SOFTWARE CONFIGURATION

Software configuration of your A30 camera can be accomplished by the procedures described in the Impact Reference Guide. Vision Program Manager (VPM) is used to configure the camera for specific applications, and provides the tools to create vision programs.

### VPM™ SYSTEM REQUIREMENTS

A client computer is required to install and run Impact software and configure the camera. You should have a Laptop or PC that meets or exceeds the requirements defined in the system requirements section of the Impact Reference Guide. Machine Vision installation software can be downloaded from the Datalogic web site ([www.datalogic.com](http://www.datalogic.com)).

### INSTALLING IMPACT SOFTWARE

To install Impact Software, proceed as follows:

1. Turn on the Laptop or PC that will be used for configuration (connected to the Ethernet port of the A30 camera).
2. You may need to turn off automatic virus checking during the install if it causes installation problems.
3. You must log in to an operating system account that has administrative privileges in order to install or run Impact software on a Windows operating system.
4. To be able to communicate, the client and device's IP addresses for the local area connection must be configured. The vision device is shipped with a factory default IP address of 192.168.0.128 and a default mask of 255.255.255.0. If you need to change the device's IP address or mask, do so before installation.
5. Double-click on the downloaded installation program.
6. The installation program should start. Select the language you want the install to use, then click OK.
7. Follow the on-screen instructions. You will have the option to install Impact software to the client, camera, or both.  
Note: If security is enabled on the camera, you cannot install new software on it. You must exit the install program, disable security on the camera, then restart the install.
8. When the installation has completed, you can start VPM.

### Changing the Camera's IP Address

1. Connect to the device with VPM.

2. Select the Settings tab.
3. Click the General System Object.
4. Select the General radio button.
5. Enter the desired IP address in the IP Address field.
6. Press the Tab key.
7. When the Reboot dialog is displayed, click OK.
8. Cycle power on the camera.

### Changing the Client's IP Address (Windows XP)

**IMPORTANT NOTE:** On the M-Series Processor, change only the Local Area Connection named LAN1 or LAN2. These correspond to Ethernet Ports 1 and 2 on the front of the processor. **DO NOT** change any of the other Local Area Connections.

1. In the Start menu, right click on My Network Places and select Properties.
2. Right click Local Area Connection LAN1 or LAN2 and select Properties.

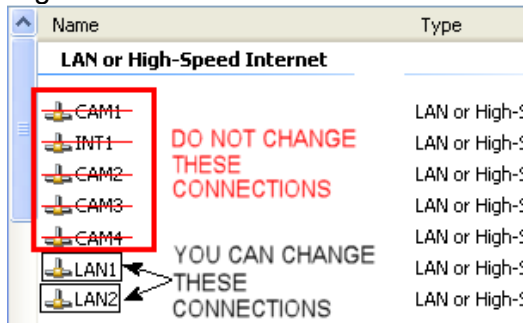

3. On the General tab, select Internet Protocol (TCP/IP) and click Properties.
4. On the General tab, select Use the following IP address.
5. Enter the desired IP address.
6. Click OK to close all the open dialog windows.

### Changing the Client's IP Address (Windows 7)

**IMPORTANT NOTE:** On the M-Series Processor, change only the Local Area Connection named LAN1 or LAN2. These correspond to Ethernet Ports 1 and 2 on the front of the processor. **DO NOT** change any of the other Local Area Connections.

1. In the Start menu, click on Control Panel.
2. Under Network and Internet, click on View Network Status and Tasks.
3. On the left side of the screen, click Change Adapter Settings.

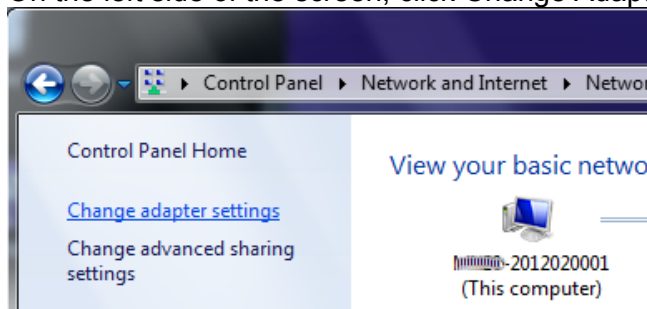

- Right click Local Area Connection (or LAN1 or LAN 2) and select Properties.

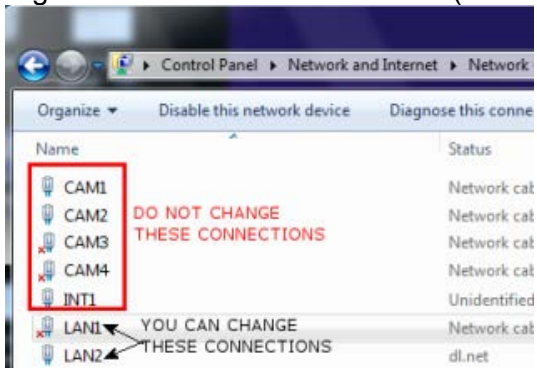

- In the list of items, select Internet Protocol Version 4 (TCP/IPv4), then click Properties.

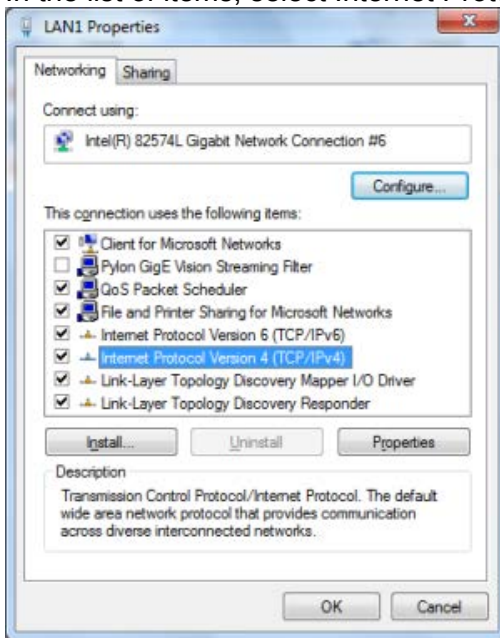

- Select Use the following IP address.
- Enter the desired IP address.
- Click OK to close all the open dialog windows.

## TECHNICAL FEATURES

<b>ELECTRICAL FEATURES</b>	
<b>Power</b>	
Supply Voltage	10-30 Vdc $\pm$ 20%
Consumption (max)	0.8 to 0.27 A, 8 W max.; 0.5 to 0.17 A, 5 W typical
<b>Communication Interfaces</b>	
RS232	2400 to 115200 bit/s
Ethernet	10/100/1000 Mbit/s, Gigabit Ethernet
<b>Inputs</b>	
Input 1(External Trigger) and Input 2	Opto-coupled and polarity insensitive
Max. Voltage	30 Vdc
Max. Input Current	10 mA
<b>Outputs</b>	
Output 1, Output 2 and Strobe/Output 3	Opto-coupled
V <sub>Out</sub> (I <sub>Load</sub> = 0 mA) Max.	30 Vdc
V <sub>Out</sub> (I <sub>Load</sub> = 10 mA) Max.	1.8 Vdc
P <sub>D</sub> = V <sub>Out</sub> x I <sub>Load</sub> Max.	170 mW
<b>OPTICAL FEATURES</b>	
Image Sensor	CCD
Image Format	640 x 480
Frame Rate	60 frames/sec
<b>ENVIRONMENTAL FEATURES</b>	
Operating Temperature <sup>1</sup>	0 to 45 °C (32 to 113 °F)
Storage Temperature	-20 to 70 °C (-4 to 158 °F)
Max. Humidity	90% non-condensing
Vibration Resistance EN 60068-2-6	14 mm @ 2 to 10 Hz; 1.5 mm @ 13 to 55 Hz; 2 g @ 70 to 200 Hz; 2 hours on each axis
Shock Resistance EN 60068-2-27	30g; 11 ms 3 shocks on each axis
Protection Class <sup>2</sup> EN 60529	IP67
<b>PHYSICAL FEATURES</b>	
Dimensions	125 x 65 x 86 mm (4.92 x 2.56 x 3.39 in.) with lens cover
Weight (with lens)	482 g. (17 oz.)
Material	Aluminum
<b>Parameter Storage</b>	Permanent memory (Flash)
<b>USER INTERFACE</b>	
LED Indicators	Power, Busy/Trigger, Out 1; Out 2; Out 3, Online
Keypad Button	Reset

<sup>1</sup> High ambient temperature applications should use metal mounting bracket for heat dissipation.

<sup>2</sup> Requires correct connection to IP67 cables with seals and Lens Cover mounting.

[www.datalogic.com](http://www.datalogic.com)